

























**KEJUARAAN NASIONAL KARATE PIALA KETUA
UMUM PB FORKI TAHUN 2022 - 2022-10-03**

Medals - Club





Rank	Club	1. Place	2. Place	3. Place
1	 INKAI, INA	2	1	1
2	 LEMKARI, INA	2	0	1
3	 JAWA BARAT, INA	1	4	0
4	 DKI JAKARTA, INA	1	1	1
5	 KKI, INA	1	0	2
6	 SUMATERA UTARA, INA	1	0	1
7	 BALI, INA	1	0	0
	 SULAWESI UTARA, INA	1	0	0
9	 JAWA TIMUR, INA	0	1	1
10	 MALUKU, INA	0	1	0
	 GOJUKAI, INA	0	1	0
	 KEI SHIN KAN, INA	0	1	0
13	 INKANAS, INA	0	0	3
14	 LAMPUNG, INA	0	0	2
	 WADOKAI, INA	0	0	2
16	 BKC, INA	0	0	1
	 JAWA TENGAH, INA	0	0	1
	 ASKI, INA	0	0	1
	 SUMATERA BARAT A, INA	0	0	1
	 ACEH, INA	0	0	1



**KEJUARAAN NASIONAL KARATE PIALA KETUA
UMUM PB FORKI TAHUN 2022 - 2022-10-03**





Official Results

KADET KATA PERORANGAN PUTRA				
1	NAUFAL PUTRA DIANDRA	INKAI		INA - INDONESIA
2	MUHAMMAD PASYA ARDIANSYAH IN	DKI JAKARTA		INA - INDONESIA
3	VICTOR BELVA ANANTA NURRACHMAN IN	JAWA TIMUR		INA - INDONESIA
3	HARAY SHOKE LAMINDO GA	LAMPUNG		INA - INDONESIA

KADET KATA PERORANGAN PUTRI				
1	RENATA GLORY MADA O ID	JAWA BARAT		INA - INDONESIA
2	SALSABILA RIHHADATUL`AISY AMRULLAH	KEI SHIN KAN		INA - INDONESIA
3	KANAYA SCARLETTA POLII	INKANAS		INA - INDONESIA
3	NADLIMA LAYLA IN	DKI JAKARTA		INA - INDONESIA

KADET KUMITE PUTRA +70 KG				
1	MUHAMMAD PADI FAUZAN SYAM	KKI		INA - INDONESIA
2	RACKEE BALARAMA	INKAI		INA - INDONESIA
3	AQDAS MIFTAHUL KASFILLAH	INKANAS		INA - INDONESIA
3	NAUFAL DZAKY ANSYORI IS	SUMATERA BARAT A		INA - INDONESIA

KADET KUMITE PUTRA -52 KG				
1	M DHIJEY LEXSIE SI	SUMATERA UTARA		INA - INDONESIA
2	ARJEN PAAIS LK	MALUKU		INA - INDONESIA
3	MADE RYAN ADITYA JAYA	KKI		INA - INDONESIA
3	TIO TRIRALY SAMBENTIRO	WADOKAI		INA - INDONESIA

KADET KUMITE PUTRA -57 KG				
1	KADEK ANGGA PRADITA LK	BALI		INA - INDONESIA
2	YANUR SYAFA`AT SABILILLAH IN	JAWA TIMUR		INA - INDONESIA
3	FAHREL APRIANSYAH AMARTHA KI	LAMPUNG		INA - INDONESIA
3	AURIGA ARYASATYA MULYANTO AS	JAWA TENGAH		INA - INDONESIA

KADET KUMITE PUTRA -63 KG				
1	DINO BAGUS ARYO SETO	LEMKARI		INA - INDONESIA
2	MOCHAMMAD FEBRILYANSYAH LK	JAWA BARAT		INA - INDONESIA
3	FAREL ARAFI HILMANSYAH LK	SUMATERA UTARA		INA - INDONESIA

KADET KUMITE PUTRA -70 KG				
1	ALFIAN SURYA	INKAI		INA - INDONESIA
2	BILLY PASYAH PURNOMO BC	JAWA BARAT		INA - INDONESIA
3	RAIHANI IRFANDA	LEMKARI		INA - INDONESIA
3	YOHANES RADO SUMANIK	BKC		INA - INDONESIA

KADET KUMITE PUTRI +54 KG				
1	NAFAHATIN FADILLAH ARAFAT	LEMKARI		INA - INDONESIA

**KEJUARAAN NASIONAL KARATE PIALA KETUA
UMUM PB FORKI TAHUN 2022 - 2022-10-03**

Official Results

2	GHINA MUFIDA	GOJUKAI		INA - INDONESIA	
3	RAHMATIKA DWI WAHYUNINGRUM	INKAI		INA - INDONESIA	
3	FAKHRIYYAH HAMID	KKI		INA - INDONESIA	

KADET KUMITE PUTRI -47 KG

1	FAYYAZA LAIQHA ZAHLULA IN	DKI JAKARTA		INA - INDONESIA	
2	KIRANA ANISA-BC	JAWA BARAT		INA - INDONESIA	
3	SALWA ALYA ERSATAMA	ASKI		INA - INDONESIA	
3	SYIFA SALSABILA	WADOKAI		INA - INDONESIA	

KADET KUMITE PUTRI -54 KG

1	ERINE BRYTHANIA AURORA POTOROLI IN	SULAWESI UTARA		INA - INDONESIA	
2	NADHYA IS	JAWA BARAT		INA - INDONESIA	
3	AINI CITRA DEVI	INKANAS		INA - INDONESIA	
3	LUTHFIA ALINI KI	ACEH		INA - INDONESIA	

**KEJUARAAN NASIONAL KARATE PIALA KETUA
UMUM PB FORKI TAHUN 2022 - 2022-10-03
KADET KATA PERORANGAN PUTRA**

R1 G1/4 (7) Tatami 1 10:30(2022-10-03)

Competitors	Kata	1T	1A	2T	2A	3T	3A	4T	4A	5T	5A	6T	6A	7T	7A	TEC	ATH	Extra	Total	Rank
1 SABIL NUR_RAMADHAN_IN (KALIMANTAN TIMUR)	UNSU	(7.2)	(7.4)	(7.4)	(7.2)	(7.2)	7.2	7.2	(6.8)	7.2	7.2	7.2	7.2	(7.0)	(7.0)	15.126	6.48		21.6	2
2 ABEL ALDRICH_IN (JAMBI)	UNSU	7.4	(7.6)	7.2	7.4	(7.6)	(7.6)	7.2	(7.0)	(7.0)	(7.0)	(7.6)	7.4	(7.0)	7.0	15.266	6.54		21.8	1
3 M IRHAM_ABDILLAH (GOJUKAI)	SUPARINPEI	(6.6)	(6.8)	7.0	(6.8)	(7.6)	(7.4)	(6.8)	6.8	7.0	(6.6)	7.0	6.8	(7.2)	6.8	14.7	6.12		20.824	
4 TELEKA SITEPU (GABDIKA SHITORYUKAI)	CHATANYARA KUSHANKU	(6.4)	(6.6)	(7.0)	7.0	(7.4)	(7.4)	7.0	(7.2)	(6.6)	(6.8)	6.8	6.8	6.8	6.8	14.426	6.18		20.6	5
5 AHMAD YUDHA_PRATAMA_ASIKIN (KEI SHIN KAN)	CHATANYARA KUSHANKU	(6.8)	7.0	(7.2)	(7.2)	(7.2)	(7.4)	7.0	(6.6)	6.8	(6.6)	6.8	6.6	(6.6)	6.8	14.426	6.12		20.546	
6 RADITYA IN (SULAWESI TENGAH)																				
7 BINTANG TESA_HARIYANTO_AS (SUMATERA BARAT A) (*4)	KANKU SHO	(7.0)	7.2	(7.6)	(7.4)	(7.6)	(7.6)	7.2	7.0	(6.8)	(6.8)	7.4	7.2	7.0	(6.4)	15.126	6.42		21.543	

R1 G2/4 (7) Tatami 1 11:30(2022-10-03)

Competitors	Kata	1T	1A	2T	2A	3T	3A	4T	4A	5T	5A	6T	6A	7T	7A	TEC	ATH	Extra	Total	Rank
1 HASBI IRAWAN_IS (JAWA BARAT)	CHATANYARA KUSHANKU	(7.0)	(7.2)	7.0	(6.8)	(6.8)	(6.8)	7.2	7.0	7.2	7.2	(7.4)	(7.4)	(7.4)	7.2	14.986	6.42		21.4	3
2 HARAY SHOKE_LAMINDO_GA (LAMPUNG)	PAPUREN	7.2	7.2	7.2	(7.4)	(6.4)	(6.4)	(7.0)	(6.8)	7.0	6.8	(7.6)	7.4	(7.4)	(7.6)	14.986	6.42		21.4	4
3 IRFAN ANWAR_SONDAKH_LK (SULAWESI UTARA)	UNSU	(6.6)	6.8	6.8	(7.0)	(6.6)	(6.6)	6.8	(6.6)	6.8	6.8	(7.0)	(7.0)	(7.2)	7.0	14.286	6.18		20.466	
4 ARIQ MAULANA_FARUQ_IBRAHIM_IN (SUMATERA SELATAN)	UNSU	(6.0)	(6.2)	(6.2)	6.2	6.4	(6.0)	(6.6)	(6.6)	6.6	6.4	6.2	6.2	(6.8)	(6.8)	13.445	5.64		19.087	
5 I KETUT_VICKY_MAHARDIKA_LK (BALI)		(7.2)	(7.4)	(6.6)	6.6	7.0	(7.0)	(6.4)	(6.4)	7.2	7.0	6.6	(6.4)	(7.4)	7.0	14.566	6.18		20.745	
6 VALENT OLIVER_CAN_GK (JAWA TENGAH)		(7.4)	7.4	(7.4)	(7.6)	(7.2)	(7.0)	7.4	(7.2)	7.4	7.4	(7.2)	7.2	7.4	(7.6)	15.546	6.6		22.141	
7 MUHAMMAD PASYA_Ardiansyah_IN (DKI JAKARTA) (*2)		(7.4)	(7.6)	(7.4)	7.2	(6.8)	(7.0)	7.4	(7.4)	(7.0)	7.2	7.2	(7.0)	7.2	7.2	15.266	6.48		21.742	

R1 G3/4 (7) Tatami 2 10:30(2022-10-03)

Competitors	Kata	1T	1A	2T	2A	3T	3A	4T	4A	5T	5A	6T	6A	7T	7A	TEC	ATH	Extra	Total	Rank
1 FARIS UKMALI_IS (ACEH)	PAPUREN	(6.6)	(6.4)	(6.8)	(6.6)	6.8	6.8	7.0	6.8	(7.4)	7.0	(7.4)	(7.2)	7.2	(7.4)	14.7	6.18		20.884	
2 KHAIRUL IHSAN (GOKASI)	KANKU SHO	(6.4)	(6.2)	(6.6)	6.6	6.6	(6.4)	6.8	6.6	(7.0)	(7.2)	(7.4)	(7.4)	7.0	7.0	14.286	6.06		20.346	
3 TSAQIF WADI_RAMADHAN_IN (RIAU)	UNSU	6.8	(6.6)	6.8	6.8	(6.4)	(6.6)	(6.6)	6.6	7.0	7.0	(7.6)	(7.6)	(7.4)	(7.2)	14.426	6.12		20.545	
4 RAIHAN DHIYA_SYAUQI (INKADO)	UNSU	(6.6)	6.6	7.0	6.6	(6.2)	(6.4)	7.0	(6.4)	(7.4)	7.2	(7.6)	(7.8)	7.4	(7.6)	14.986	6.12		21.1	3
5 RAZENDRA RAKA_MUFTI (WADOKAI)	ANAN DAI	(6.2)	(6.0)	6.4	(6.2)	(6.2)	6.2	(6.8)	6.2	6.8	(7.0)	(7.2)	(7.2)	6.8	7.0	14.0	5.82		19.827	
6 SATRIA NURWAHYU (BUDOKAI)	SUPARINPEI	(7.4)	(7.2)	7.4	7.4	7.4	7.4	(7.2)	(7.0)	7.4	7.2	(7.6)	(7.6)	(7.6)	(7.8)	15.546	6.6		22.141	
7 TAUFIK AKBAR_GK (SUMATERA BARAT B) (*3)	SUPARINPEI	(7.2)	7.2	7.2	(7.0)	7.2	7.2	(7.0)	(6.4)	7.2	7.2	(7.8)	(7.8)	(7.4)	(7.6)	15.126	6.48		21.6	2

R1 G4/4 (7) Tatami 2 11:30(2022-10-03)

Competitors	Kata	1T	1A	2T	2A	3T	3A	4T	4A	5T	5A	6T	6A	7T	7A	TEC	ATH	Extra	Total	Rank
1 MOH RIZKY_SUDARMO_WK (GORONTALO)	ANAN DAI	(7.2)	(7.2)	(7.0)	(7.0)	(7.2)	(7.0)	7.2	7.0	7.2	7.0	(6.6)	(6.4)	7.2	7.0	15.126	6.3		21.424	
2 M DHIJEY_LEXSIE_SI (SUMATERA UTARA)	ANAN	7.0	(7.2)	(7.4)	(7.2)	(7.4)	7.2	7.0	(6.8)	7.0	7.0	(6.6)	(6.6)	(6.8)	7.0	14.7	6.36		21.065	
3 GHALLAH ATTHARIEQSYAH_ID (KEPULAUAN RIAU)	ANAN DAI	(7.2)	(7.4)	(7.0)	(6.8)	7.0	6.8	(6.8)	(7.0)	7.0	6.8	(6.4)	(6.2)	7.0	6.8	14.7	6.12		20.826	
4 NAUFAL PUTRA_DIANDRA (INKAI)	KANKU SHO	7.4	(7.6)	7.4	(7.2)	(7.6)	7.4	7.4	7.2	(6.8)	7.2	(6.8)	(6.8)	(7.8)	(7.8)	15.546	6.54		22.082	
5 VICTOR BELVA_ANANTA_NURRACHMAN_IN (JAWA TIMUR)	KANKU SHO	(7.6)	(7.8)	7.4	7.4	7.4	7.4	7.4	7.4	(6.8)	(6.8)	(6.6)	(6.4)	(7.6)	(7.8)	15.546	6.66		22.2	1
6 RAHMAT H (SHIROITE)	UNSU	(6.8)	6.8	(7.0)	(7.0)	6.8	(7.0)	6.8	(6.6)	6.8	6.6	(6.2)	(6.0)	(7.0)	6.6	14.286	6.0		20.287	
7 BAGASKARA EDYtia_PUTra_IN (KALIMANTAN SELATAN) (*1)	KANKU SHO	(7.6)	(7.6)	(7.4)	(7.4)	(7.2)	(6.8)	7.4	7.2	7.2	7.2	(7.0)	(6.8)	7.4	7.2	15.4	6.48		21.883	

R2-G1 Tatami 1 12:20(2022-10-03)

Competitors	Kata	1T	1A	2T	2A	3T	3A	4T	4A	5T	5A	6T	6A	7T	7A	TEC	ATH	Extra	Total	Rank
1 HASBI IRAWAN_IS (JAWA BARAT)	UNSHU	7.2	7.4	(7.8)	(7.8)	7.4	(7.2)	(6.8)	(7.2)	(7.6)	(7.6)	7.2	7.4	(7.0)	7.2	15.266	6.6		21.866	
2 M IRHAM_ABDILLAH (GOJUKAI)	ANAN DAI	(7.4)	(7.2)	(7.8)	(7.8)	(7.2)	(7.4)	(7.0)	7.2	7.4	7.4	7.2	7.2	(7.0)	(7.0)	15.4	6.54		21.945	
3 MUHAMMAD PASYA_Ardiansyah_IN (DKI JAKARTA)	KANKU SHO	7.4	(7.4)	(7.8)	(7.6)	7.4	(6.8)	(6.8)	(7.0)	(7.8)	7.4	(7.2)	7.2	7.4	7.2	15.546	6.54		22.082	
4 VALENT OLIVER_CAN_GK (JAWA TENGAH)	CHIBANA NO KUSHANKU	(7.6)	(7.4)	(7.4)	(7.6)	7.4	(7.0)	(7.2)	(7.2)	(7.6)	7.2	7.6	7.4	7.4	7.2	15.686	6.54		22.221	
5 ABEL ALDRICH_IN (JAMBI)	SANSAI	(7.8)	7.4	(7.8)	(7.8)	(7.2)	(7.2)	(7.0)	7.4	7.2	7.2	7.6	(7.6)	7.2	(7.0)	15.4	6.6		22.0	4
6 SABIL NUR_RAMADHAN_IN (KALIMANTAN TIMUR)	GANKAKU	(7.6)	(7.6)	(7.8)	(7.6)	7.4	7.2	(7.2)	7.4	(7.0)	(7.0)	7.2	7.0	7.2	(6.8)	15.266	6.48		21.747	
7 HARAY SHOKE_LAMINDO_GA (LAMPUNG)	ANAN DAI	(7.4)	(7.4)	(7.2)	(7.2)	(7.4)	(7.4)	7.4	7.4	7.4	7.2	7.4	7.2	(7.2)	(6.8)	15.546	6.54		22.083	
8 BINTANG TESA_HARIYANTO_AS (SUMATERA BARAT A)	GANKAKU	(7.6)	(7.2)	(7.6)	7.2	7.2	(7.4)	7.2	(6.8)	(7.0)	6.8	7.0	6.8	(6.8)	(6.6)	14.986	6.24		21.228	

R2-G2 Tatami 2 12:20(2022-10-03)

Competitors	Kata	1T	1A	2T	2A	3T	3A	4T	4A	5T	5A	6T	6A	7T	7A	TEC	ATH	Extra	Total	Rank
1 SATRIA NURWAHYU (BUDOKAI)	ANAN	(7.6)	(7.4)	(7.4)	7.4	(7.6)	7.4	(7.4)	(7.2)	7.4	7.4	7.6	(7.6)	7.6	(7.2)	15.826	6.66		22.481	

**KEJUARAAN NASIONAL KARATE PIALA KETUA
UMUM PB FORKI TAHUN 2022 - 2022-10-03
KADET KATA PERORANGAN PUTRA**

2	VICTOR BELVA ANANTA_NURRACHMAN_IN (JAWA TIMUR)	GANKAKU	(7.8)	(7.6)	(7.2)	(7.0)	(7.2)	(7.0)	(7.6)	7.4	7.6	7.6	7.4	(7.8)	7.4	7.2	15.68	6.66		22.34	2
3	BAGASKARA EDYTIA_PUTRA_IN (KALIMANTAN SELATAN)	GOJUSHIHO SHO	(7.8)	(7.8)	(7.2)	7.4	(7.2)	(7.0)	7.2	(7.2)	(7.6)	(7.8)	7.2	7.4	7.4	7.6	15.26	6.72		21.98	6
4	NAUFAL PUTRA_DIANDRA (INKAI)	GOJUSHIHO SHO	(8.0)	(7.8)	7.4	7.2	(7.0)	(7.0)	(7.2)	(7.0)	7.6	(7.6)	(7.8)	7.4	7.4	7.4	15.68	6.6		22.28	3
5	FARIS UKMALI_IS (ACEH)	UNSU	(7.6)	(7.6)	(6.8)	(7.0)	(7.2)	(7.2)	7.4	7.4	(7.6)	(7.8)	7.4	7.4	7.2	7.4	15.4	6.66		22.06	4
6	MOH RIZKY_SUDARMONO_WK (GORONTALO)	ANAN DAI	(7.2)	(7.2)	(7.0)	(6.8)	(6.8)	(6.8)	7.2	7.0	(7.6)	(7.4)	7.2	7.0	7.2	7.0	15.12	6.3		21.42	8
7	TAUFIK AKBAR_GK (SUMATERA BARAT B)	ANAN DAI	(7.4)	(7.4)	7.2	7.2	(6.8)	(6.6)	7.2	(7.0)	(7.8)	(7.6)	(7.0)	7.0	7.4	7.4	15.26	6.48		21.74	7
8	RAIHAN DHIYA_SYAUQI (INKADO)	ANAN DAI	(7.4)	7.2	(6.8)	(6.8)	7.4	(7.0)	7.4	(7.4)	(7.8)	(7.8)	(6.8)	7.2	7.4	7.2	15.54	6.48		22.02	5

R3-G1 Tatami 1 13:10(2022-10-03)

Competitors	Kata	1T	1A	2T	2A	3T	3A	4T	4A	5T	5A	6T	6A	7T	7A	TEC	ATH	Extra	Total Rank	
1 MUHAMMAD PASYA_Ardiansyah_IN (DKI JAKARTA)		(7.6)	(7.4)	(7.2)	(7.4)	(7.4)	(7.2)	7.4	7.4	(7.2)	(7.0)	7.4	7.4	7.4	7.4	15.54	6.66		22.2	1
2 HARAY SHOKE_LAMINDO_GA (LAMPUNG)		(7.4)	(7.2)	7.2	7.0	(7.0)	(6.8)	(7.6)	(7.6)	(7.0)	(6.8)	7.2	7.0	7.4	7.2	15.26	6.36		21.62	3
3 ABEL ALDRICH_IN (JAMBI)		(7.2)	(7.4)	7.2	7.2	(6.6)	(6.6)	7.2	(7.0)	(7.0)	7.0	(7.6)	(7.6)	7.2	7.0	15.12	6.36		21.48	4
4 VALENT OLIVER_CAN_GK (JAWA TENGAH)		(7.8)	(7.6)	(7.0)	(7.2)	7.4	7.4	(7.2)	(7.2)	7.4	7.4	7.2	7.4	(7.6)	(7.6)	15.4	6.66		22.06	2

R3-G2 Tatami 2 13:10(2022-10-03)

Competitors	Kata	1T	1A	2T	2A	3T	3A	4T	4A	5T	5A	6T	6A	7T	7A	TEC	ATH	Extra	Total Rank	
1 NAUFAL PUTRA_DIANDRA (INKAI)		(7.6)	(7.8)	(7.8)	(7.6)	(7.6)	(7.4)	7.6	7.4	7.6	7.4	7.6	7.6	(7.0)	(7.2)	15.96	6.72		22.68	1
2 VICTOR BELVA ANANTA_NURRACHMAN_IN (JAWA TIMUR)		(7.4)	(7.6)	(7.0)	(6.8)	7.4	(7.0)	7.4	7.2	7.4	7.2	(7.6)	(7.4)	(7.2)	7.2	15.54	6.48		22.02	3
3 SATRIA NURWAHYU (BUDOKAI)		(7.6)	(7.6)	(7.6)	(7.4)	(7.4)	(6.8)	(7.4)	(7.2)	7.4	7.4	7.4	7.2	7.4	7.2	15.54	6.54		22.08	2
4 FARIS UKMALI_IS (ACEH)		(7.4)	(7.4)	(7.2)	(7.0)	(7.0)	(6.6)	(7.2)	7.2	7.2	7.2	(7.4)	7.2	7.0	7.0	15.12	6.42		21.54	4

R4 Bronze Medal Match 1 Tatami 1 13:35(2022-10-03)

Competitors	Kata	1T	1A	2T	2A	3T	3A	4T	4A	5T	5A	6T	6A	7T	7A	TEC	ATH	Extra	Total Rank	
1 VALENT OLIVER_CAN_GK (JAWA TENGAH)		(7.4)	(7.4)	(7.4)	(7.2)	(7.6)	(7.6)	7.4	7.4	(7.6)	7.4	7.4	(7.2)	7.6	7.4	15.68	6.66		22.34	2
2 VICTOR BELVA ANANTA_NURRACHMAN_IN (JAWA TIMUR)		(7.8)	7.6	7.6	(7.4)	(7.8)	(8.0)	7.6	(7.8)	(7.4)	(7.4)	7.6	7.4	(7.4)	7.4	15.96	6.72		22.68	1





R4 Bronze Medal Match 2 Tatami 2 13:35(2022-10-03)

Competitors	Kata	1T	1A	2T	2A	3T	3A	4T	4A	5T	5A	6T	6A	7T	7A	TEC	ATH	Extra	Total Rank	
1 HARAY SHOKE_LAMINDO_GA (LAMPUNG)		(7.4)	(7.4)	(7.4)	(7.2)	(7.8)	(8.0)	7.4	7.4	7.4	7.4	(7.2)	7.4	7.4	(7.6)	15.54	6.66		22.2	1
2 SATRIA NURWAHYU (BUDOKAI)		(7.2)	(7.2)	(7.2)	7.2	(7.6)	(7.8)	(7.4)	(7.6)	7.4	(7.0)	7.2	7.2	7.2	7.2	15.26	6.48		21.74	2

R4 Gold Medal Match Tatami 1 13:45(2022-10-03)

Competitors	Kata	1T	1A	2T	2A	3T	3A	4T	4A	5T	5A	6T	6A	7T	7A	TEC	ATH	Extra	Total Rank	
1 MUHAMMAD PASYA_Ardiansyah_IN (DKI JAKARTA)		(7.4)	(7.2)	(7.2)	7.2	(7.0)	(7.0)	(7.6)	(7.6)	7.4	7.4	7.2	7.4	7.4	(7.6)	15.4	6.6		22.0	2
2 NAUFAL PUTRA_DIANDRA (INKAI)	GANKAKU	(7.8)	7.6	(7.6)	7.6	(7.2)	(7.0)	(7.8)	(7.8)	7.6	(7.4)	7.6	7.4	7.8	(7.8)	16.1	6.78		22.88	1

Results

1	NAUFAL PUTRA DIANDRA	INKAI		INDONESIA
2	MUHAMMAD PASYA ARDIANSYAH IN	DKI JAKARTA		INDONESIA
3	VICTOR BELVA ANANTA NURRACHMAN IN	JAWA TIMUR		INDONESIA
3	HARAY SHOKE LAMINDO GA	LAMPUNG		INDONESIA

**KEJUARAAN NASIONAL KARATE PIALA KETUA
UMUM PB FORKI TAHUN 2022 - 2022-10-03
KADET KATA PERORANGAN PUTRI**

R1 G1/2 (9) Tatami 3 10:30(2022-10-03)

Competitors	Kata	1T	1A	2T	2A	3T	3A	4T	4A	5T	5A	6T	6A	7T	7A	TEC	ATH	Extra	Total Rank
1 GUMAYANG FITRI_LK (BENGKULU)	ANAN	(6.2)	(6.2)	(7.2)	(6.8)	6.8	(6.8)	6.8	(6.6)	6.6	6.8	6.6	6.6	(7.0)	6.8	14.28	6.0		20.287
2 NURUL SANDIKA_IN (KALIMANTAN TIMUR)	GOJUSHIHO DAI	(6.8)	(6.6)	(7.4)	7.0	(7.4)	(7.4)	7.0	7.0	(6.8)	(6.8)	7.2	(7.2)	7.2	7.2	14.98	6.36		21.343
3 RENATA GLORY_MADAO_ID (JAWA BARAT)	ANAN DAI	(7.4)	7.4	(7.8)	(7.6)	(7.8)	(7.8)	7.4	(7.2)	7.4	(7.2)	7.4	7.6	(7.2)	7.4	15.54	6.72		22.261
4 JHASTIEN TAUFIQ_ARIYANTI_IS (KEPULAUAN RIAU)	SANSAI	(7.2)	(7.2)	(7.4)	(7.4)	(7.0)	(7.0)	(7.0)	7.0	7.0	(6.8)	7.0	7.0	7.2	7.2	14.84	6.36		21.2 4
5 CHRISTANIA MARIA_RONDO_ID (SULAWESI UTARA)	PAPUREN	(7.6)	(7.6)	7.0	(6.6)	(6.6)	(6.6)	(6.8)	6.8	7.0	(7.0)	(7.2)	7.0	7.0	6.8	14.7	6.18		20.885
6 CHERYL INDIKAGO_BAHARIZKY (GOKASI)	ANAN DAI	(7.2)	7.4	(7.8)	(8.0)	(8.0)	(8.0)	(6.8)	(6.6)	7.2	7.2	7.4	(7.0)	7.2	7.4	15.26	6.6		21.862
7 ARUMINGTYAS KHONI_DAHLIA_SK (JAMBI)	KANKU SHO	(6.4)	(6.4)	6.6	(6.2)	(6.4)	6.4	6.4	6.4	6.6	6.6	(6.8)	(6.8)	(6.8)	(6.8)	13.72	5.82		19.549
8 KAYLA RISKIA_MAHARANI (GOJUKAI)	SUPARINPEI	(6.8)	(6.8)	6.8	(6.4)	(7.2)	(7.2)	6.8	6.6	(6.6)	(6.4)	(7.0)	6.8	7.0	6.8	14.42	6.06		20.486
9 PUTRI AZZURA_M_LK (SUMATERA BARAT B) (*2)	GANKAKU	(6.2)	(6.0)	(6.6)	(6.0)	(6.2)	6.2	6.6	(6.6)	6.6	6.4	6.6	(6.6)	(6.8)	6.4	13.86	5.7		19.568

R1 G2/2 (8) Tatami 4 10:30(2022-10-03)

Competitors	Kata	1T	1A	2T	2A	3T	3A	4T	4A	5T	5A	6T	6A	7T	7A	TEC	ATH	Extra	Total Rank
1 MAYA WIJUZANA_IS (RIAU)	GANKAKU	7.0	(6.8)	7.0	(6.8)	(6.8)	(6.8)	(6.8)	6.8	(7.2)	6.8	(7.2)	6.8	6.8	(6.4)	14.56	6.12		20.684
2 NADLIMA LAYLA_IN (DKI JAKARTA)	ANAN DAI	7.4	(7.6)	7.4	(7.2)	7.4	(7.4)	(6.8)	7.4	(7.6)	7.4	(7.8)	(7.6)	(7.2)	7.6	15.54	6.72		22.261
3 SALSABILA RIHHADATUL_AISY_AMRULLAH (KEI SHIN KAN)	PAPUREN	(6.8)	(6.8)	(7.0)	(6.8)	(7.2)	(7.2)	7.0	7.0	(7.2)	7.0	7.0	(7.2)	7.2	7.2	14.84	6.36		21.2 3
4 KANAYA SCARLETTA_POLII (INKANAS)	ANAN DAI	(7.2)	(7.2)	(7.2)	(7.2)	(7.4)	7.2	7.2	7.2	(7.0)	(7.4)	(7.0)	7.2	7.2		15.12	6.48		21.6 2
5 ALIKAMORIN FAIZAH_YURI (INKADO)	ANAN DAI	(6.6)	(6.8)	(7.0)	(7.2)	6.8	(7.0)	(6.6)	7.0	(7.4)	(7.2)	6.8	7.2	6.8	7.0	14.28	6.36		20.645
6 KEINDA ELANEL (BUDOKAI)	SUPARINPEI	6.8	(6.6)	6.8	6.6	(6.4)	(6.4)	(7.4)	(7.2)	(7.0)	6.8	6.6	(6.6)	6.6	6.6	14.28	5.94		20.227
7 MAZAYA FITRIAZKA (BKC)	UNSHU	(6.8)	(6.4)	(6.8)	(6.6)	6.8	6.6	(6.6)	(7.0)	6.8	6.6	6.6	6.6	(6.4)	(6.4)	14.14	5.94		20.088
8 NAJWA WAHYU_INSANI_GS (SUMATERA BARAT A) (*1)	SUPARINPEI	6.8	(6.4)	7.0	(6.8)	6.8	6.6	(7.2)	6.6	(7.4)	(7.2)	(6.4)	6.4	(6.2)	(6.2)	14.42	5.88		20.3 6

R2-G1 Tatami 3 11:35(2022-10-03)

Competitors	Kata	1T	1A	2T	2A	3T	3A	4T	4A	5T	5A	6T	6A	7T	7A	TEC	ATH	Extra	Total Rank
1 JHASTIEN TAUFIQ_ARIYANTI_IS (KEPULAUAN RIAU)	PAPUREN	(7.0)	(7.4)	(7.0)	(7.4)	7.2	(7.0)	7.2	(7.2)	7.2	7.4	(7.4)	7.4	(7.4)	7.4	15.12	6.66		21.783
2 CHERYL INDIKAGO_BAHARIZKY (GOKASI)	CHATANYARA KUSHANKU	(6.8)	(7.2)	(7.0)	(7.4)	7.0	(7.2)	7.0	7.2	7.4	7.4	(7.6)	(7.6)	(7.6)	7.4	14.98	6.6		21.584
3 NURUL SANDIKA_IN (KALIMANTAN TIMUR)	SANSAI	(6.8)	(7.0)	(6.8)	(7.0)	7.4	7.2	7.4	(7.4)	7.0	7.2	(7.6)	(7.6)	(7.6)	7.4	15.26	6.54		21.8 2
4 RENATA GLORY_MADAO_ID (JAWA BARAT)	PAPUREN	(7.6)	(7.8)	(7.6)	(7.6)	7.6	(7.4)	(7.8)	7.6	7.6	7.6	(7.8)	(7.8)	7.6	7.6	15.96	6.84		22.8 1

R2-G2 Tatami 4 11:35(2022-10-03)

Competitors	Kata	1T	1A	2T	2A	3T	3A	4T	4A	5T	5A	6T	6A	7T	7A	TEC	ATH	Extra	Total Rank
1 MAYA WIJUZANA_IS (RIAU)	PAPUREN	(7.0)	(6.0)	7.0	(6.8)	(7.4)	(7.6)	(7.2)	7.2	(7.4)	(6.8)	7.0	7.0	7.0	7.0	14.84	6.36		21.2 4
2 SALSABILA RIHHADATUL_AISY_AMRULLAH (KEI SHIN KAN)	SUPARINPEI	(7.0)	(7.4)	7.2	(7.0)	(7.6)	(7.4)	(7.4)	7.4	7.4	7.4	7.0	(7.0)	(6.8)	7.2	15.12	6.6		21.721
3 NADLIMA LAYLA_IN (DKI JAKARTA)	CHIBANA NO KUSHANKU	(8.0)		7.0	(7.0)	(7.8)	(7.4)	7.2	(7.6)	7.4	7.2	(6.8)	7.0	(6.6)	7.2	15.12	6.42		21.542
4 KANAYA SCARLETTA_POLII (INKANAS)	PAPUREN	(8.0)	(6.4)	7.2	(7.0)	(7.6)	(7.6)	7.2	(7.4)	(7.0)	7.4	7.0	7.2	(6.8)	7.0	14.98	6.48		21.463

R3 Bronze Medal Match 1 Tatami 3 12:05(2022-10-03)

Competitors	Kata	1T	1A	2T	2A	3T	3A	4T	4A	5T	5A	6T	6A	7T	7A	TEC	ATH	Extra	Total Rank
1 NURUL SANDIKA_IN (KALIMANTAN TIMUR)	GANKAKU	(7.0)	(7.2)	(7.6)	(7.6)	(7.0)	(7.2)	(7.2)	(7.4)	7.2	7.2	7.0	7.2	7.0	7.2	14.84	6.48		21.322
2 KANAYA SCARLETTA_POLII (INKANAS)	CHIBANA NO KUSHANKU	(7.0)	(7.0)	(7.4)	(7.6)	7.2	(7.6)	(7.4)	(7.2)	7.4	7.4	7.2	7.2	(7.0)	7.4	15.26	6.6		21.861

R3 Bronze Medal Match 2 Tatami 4 12:05(2022-10-03)





Competitors	Kata	1T	1A	2T	2A	3T	3A	4T	4A	5T	5A	6T	6A	7T	7A	TEC	ATH	Extra	Total Rank
1 JHASTIEN TAUFIQ_ARIYANTI_IS (KEPULAUAN RIAU)	CHATANYARA KUSHANKU	(7.6)	(7.8)	(7.6)	(7.4)	(7.0)	(7.2)	7.2	7.2	(7.0)	7.4	7.0	7.2	7.2	(7.0)	14.98	6.54		21.522
2 NADLIMA LAYLA_IN (DKI JAKARTA)	OHAN	(7.8)	(8.0)	(7.8)	7.6	(7.4)	(7.4)	7.6	7.4	(7.4)	(7.8)	7.4	7.4	7.4	(7.2)	15.68	6.72		22.4 1

R3 Gold Medal Match Tatami 1 13:55(2022-10-03)

Competitors	Kata	1T	1A	2T	2A	3T	3A	4T	4A	5T	5A	6T	6A	7T	7A	TEC	ATH	Extra	Total Rank
1 RENATA GLORY_MADAO_ID (JAWA BARAT)	ANAN	(7.4)	7.6	7.6	(7.4)	(8.0)	(8.0)	7.4	7.6	(7.8)	(7.8)	7.4	(7.2)	(7.2)	7.4	15.68	6.78		22.461
2 SALSABILA RIHHADATUL_AISY_AMRULLAH (KEI SHIN KAN)	ANAN DAI	(7.4)	7.2	7.4	7.2	(7.6)	(7.8)	7.4	(7.4)	7.4	7.4	(7.2)	(7.0)	(7.0)	(6.8)	15.54	6.54		22.082

**KEJUARAAN NASIONAL KARATE PIALA KETUA
UMUM PB FORKI TAHUN 2022 - 2022-10-03
KADET KATA PERORANGAN PUTRI**

Results

1	RENATA GLORY MADA O ID	JAWA BARAT		INDONESIA
2	SALSABILA RIHHADATUL AISY AMRULLAH	KEI SHIN KAN		INDONESIA
3	KANAYA SCARLETTA POLII	INKANAS		INDONESIA
3	NADLIMA LAYLA IN	DKI JAKARTA		INDONESIA

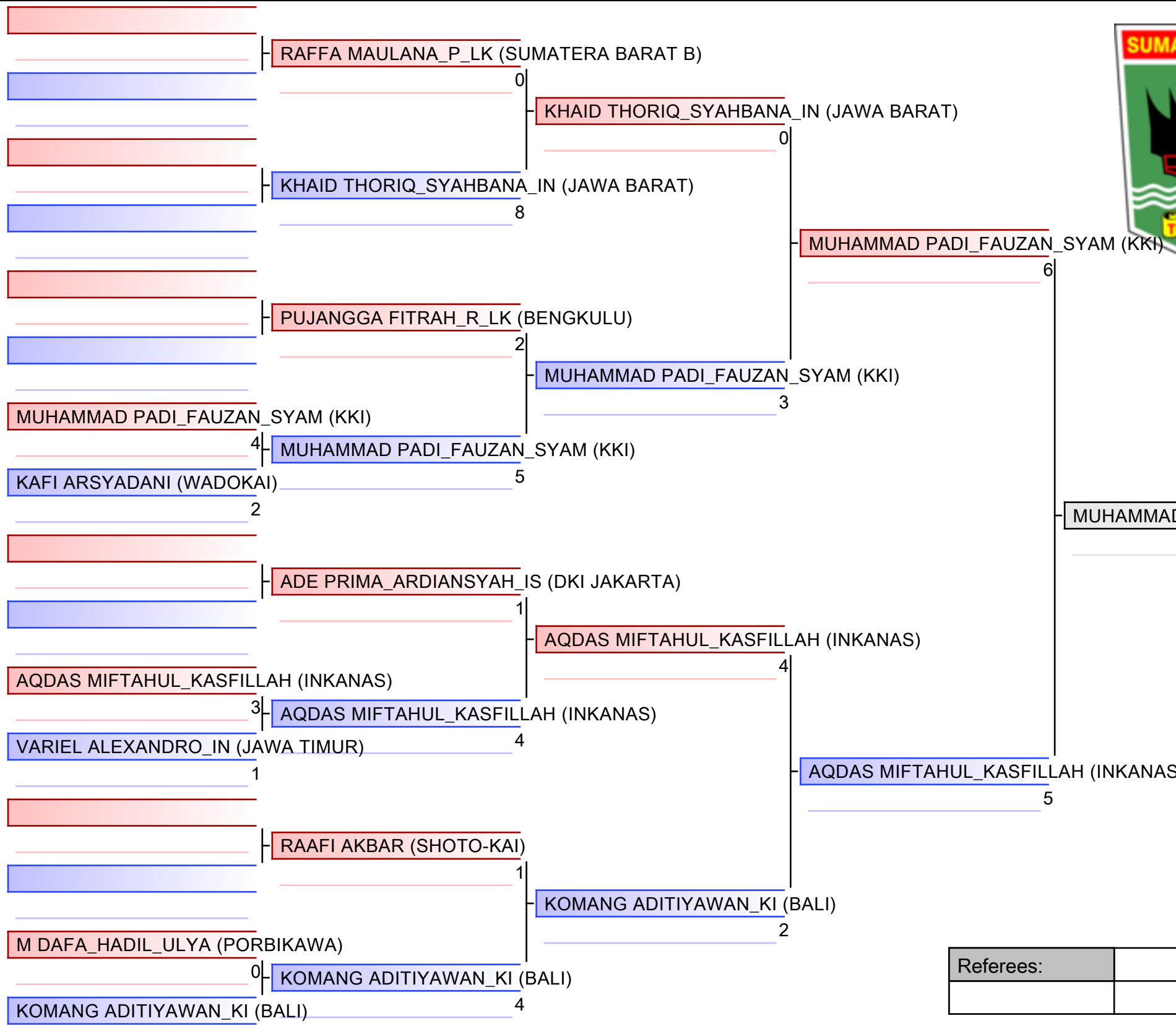

- | |
|---|
| 1. MUHAMMAD PADI_FAUZAN_SYAM (KKI) |
| 2. RACKEE BALARAMA (INKAI) |
| 3. AQDAS MIFTAHUL_KASFILLAH (INKANAS) |
| 3. NAUFAL DZAKY_ANSYORI_IS (SUMATERA BARAT) |
| 5. PUJANGGA FITRAH_R_LK (BENGKULU) |
| 5. WIRA SETYA_YUDHA_SO (RIAU) |
| 7. KHAID THORIQ_SYAHBANA_IN (JAWA BARAT) |
| 7. MUHAMMAD FAHRI_BADU_LK (GORONTALO) |

Referees:			

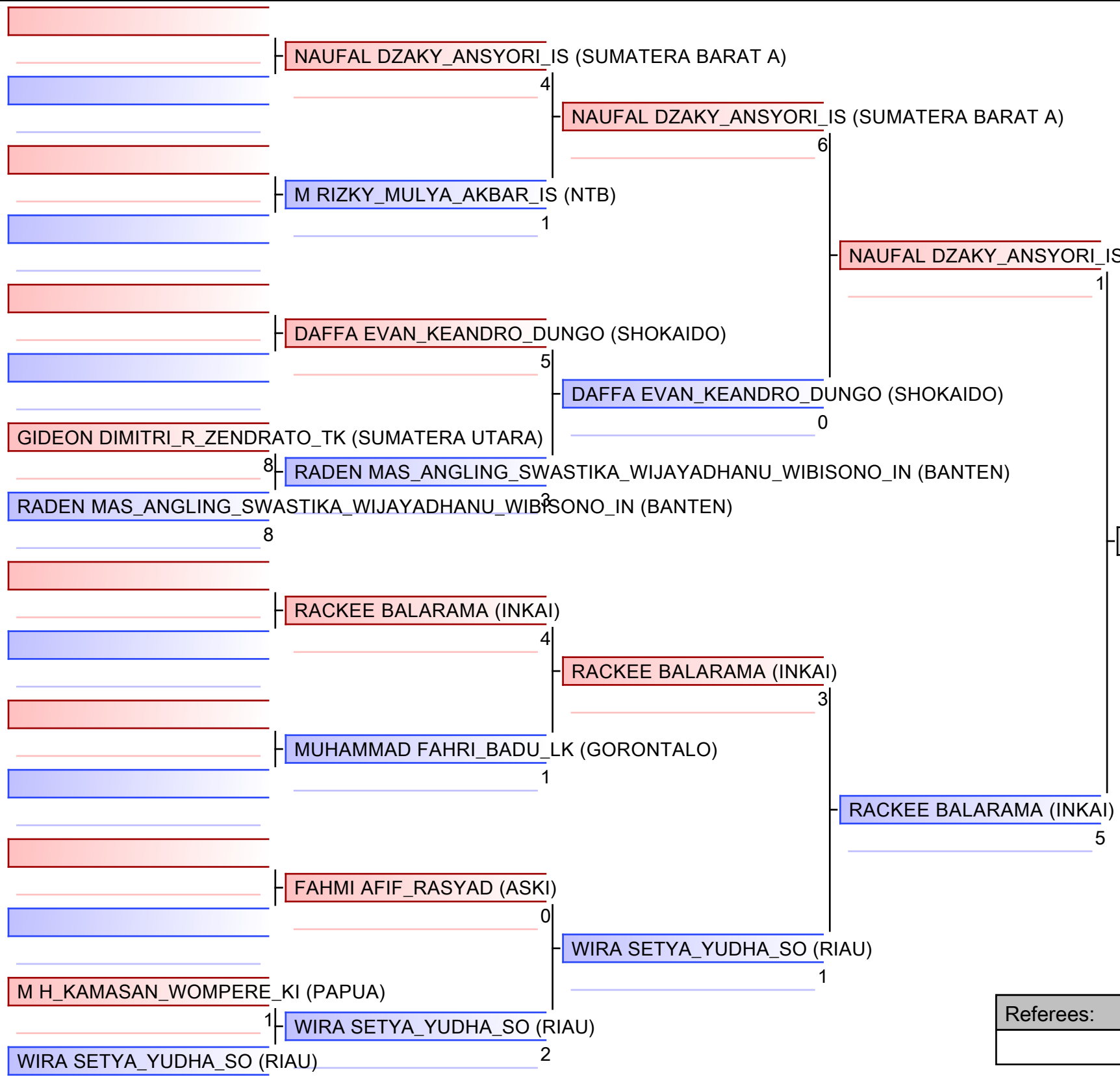

RACKEE BALARAMA (INKAI)

- | |
|---|
| 1. MUHAMMAD PADI_FAUZAN_SYAM (KKI) |
| 2. RACKEE BALARAMA (INKAI) |
| 3. AQDAS MIFTAHUL_KASFILLAH (INKANAS) |
| 3. NAUFAL DZAKY_ANSYORI_IS (SUMATERA BARAT A) |
| 5. PUJANGGA FITRAH_R_LK (BENGKULU) |
| 5. WIRA SETYA_YUDHA_SO (RIAU) |
| 7. KHAID THORIQ_SYAHBANA_IN (JAWA BARAT) |
| 7. MUHAMMAD FAHRI_BADU_LK (GORONTALO) |

Referees:			

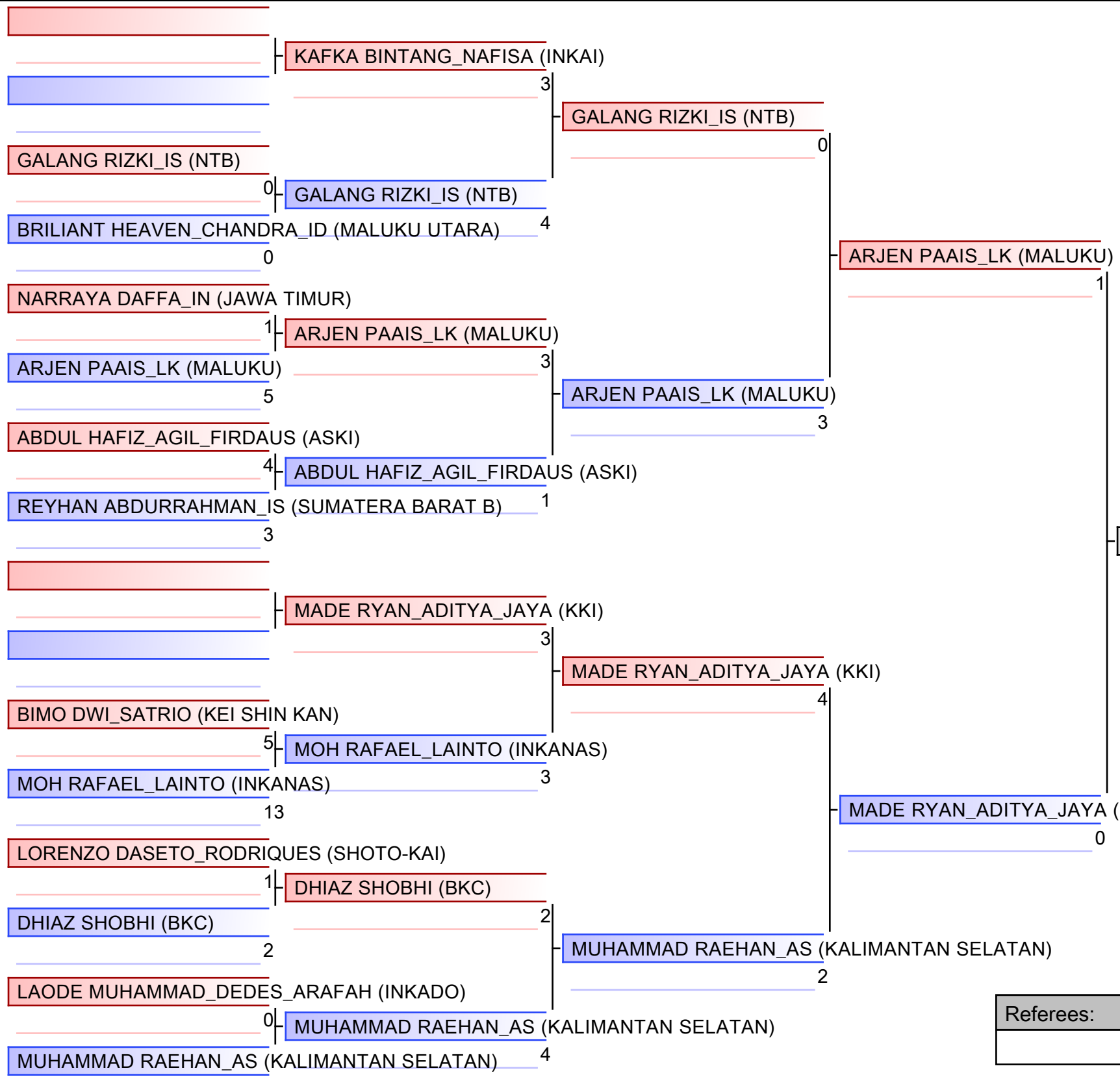

- | |
|---|
| 1. M DHIJEY_LEXSIE_SI (SUMATERA UTARA) |
| 2. ARJEN PAAIS_LK (MALUKU) |
| 3. MADE RYAN_ADITYA_JAYA (KKI) |
| 3. TIO TRIRALY_SAMBENTIRO (WADOKAI) |
| 5. GALANG RIZKI_IS (NTB) |
| 5. TAZKYA PUTRA_MASHUDI-IS (JAWA BARAT) |
| 7. ABDUL HAFIZ_AGIL_FIRDAUS (ASKI) |
| 7. KOMANG TRI_WIDHIARDIKA (LEMKARI) |

Referees:			

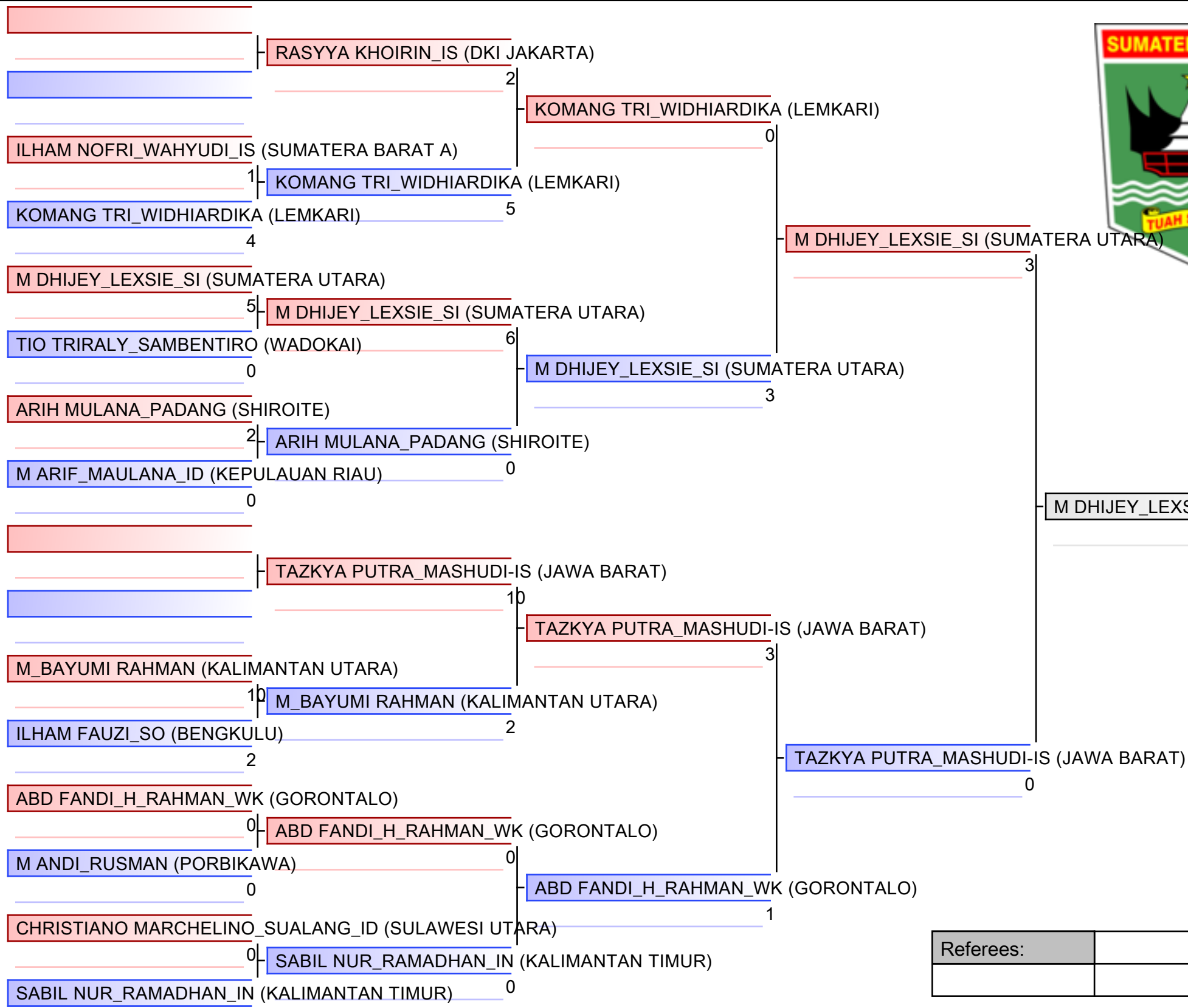

- | |
|---|
| 1. M DHIJEY_LEXSIE_SI (SUMATERA UTARA) |
| 2. ARJEN PAAIS_LK (MALUKU) |
| 3. MADE RYAN_ADITYA_JAYA (KKI) |
| 3. TIO TRIRALY_SAMBENTIRO (WADOKAI) |
| 5. GALANG RIZKI_IS (NTB) |
| 5. TAZKYA PUTRA_MASHUDI-IS (JAWA BARAT) |
| 7. ABDUL HAFIZ_AGIL_FIRDAUS (ASKI) |
| 7. KOMANG TRI_WIDHIARDIKA (LEMKARI) |

Referees:			

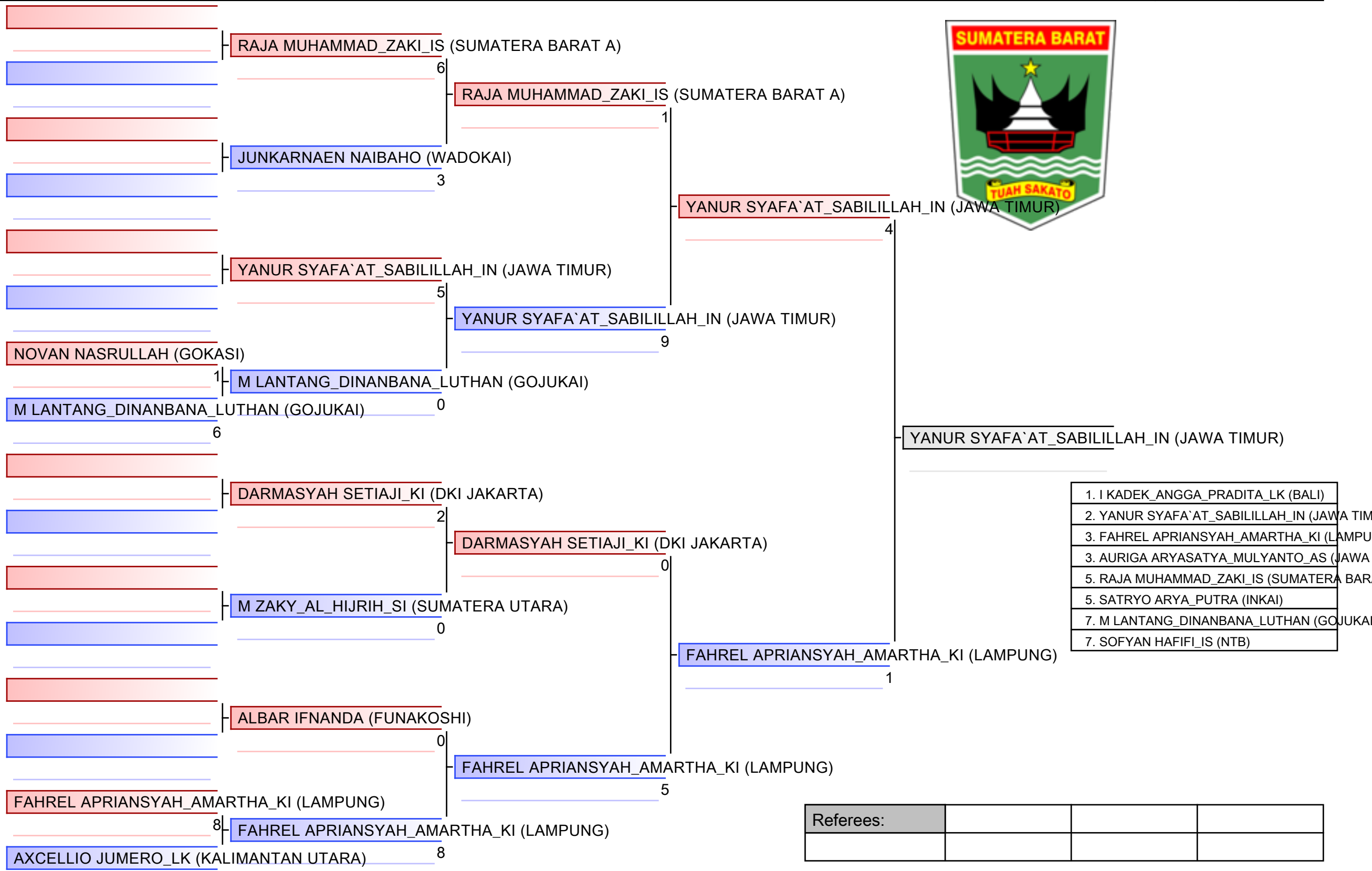

- | |
|--|
| 1. I KADEK_ANGGA_PRADITA_LK (BALI) |
| 2. YANUR SYAFA`AT_SABILILLAH_IN (JAWA TIMUR) |
| 3. FAHREL APRIANSYAH_AMARTHA_KI (LAMPUNG) |
| 3. AURIGA ARYASATYA_MULYANTO_AS (JAWA T) |
| 5. RAJA MUHAMMAD_ZAKI_IS (SUMATERA BARA) |
| 5. SATRYO ARYA_PUTRA (INKAI) |
| 7. M LANTANG_DINANBANA_LUTHAN (GOJUKAI) |
| 7. SOFYAN HAFIFI_IS (NTB) |

Referees:			

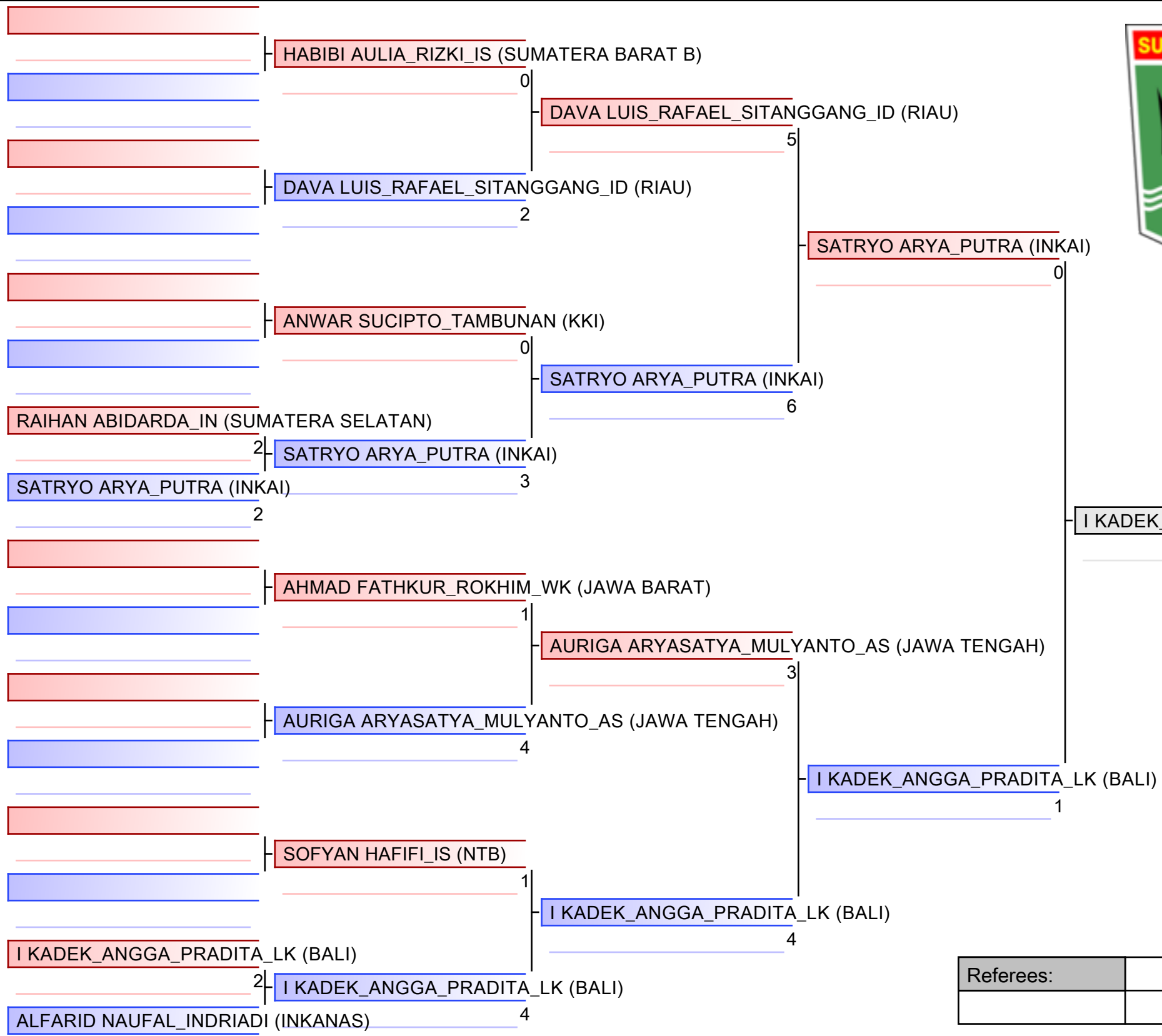

- | |
|---|
| 1. I KADEK_ANGGA_PRADITA_LK (BALI) |
| 2. YANUR SYAFA'AT_SABILILLAH_IN (JAWA TIMUR) |
| 3. FAHREL APRIANSYAH_AMARTHA_KI (LAMPUNG) |
| 3. AURIGA ARYASATYA_MULYANTO_AS (JAWA TENGAH) |
| 5. RAJA MUHAMMAD_ZAKI_IS (SUMATERA BARAT) |
| 5. SATRYO ARYA_PUTRA (INKAI) |
| 7. M LANTANG_DINANBANA_LUTHAN (GOJUKAI) |
| 7. SOFYAN HAFIFI_IS (NTB) |

Referees:			

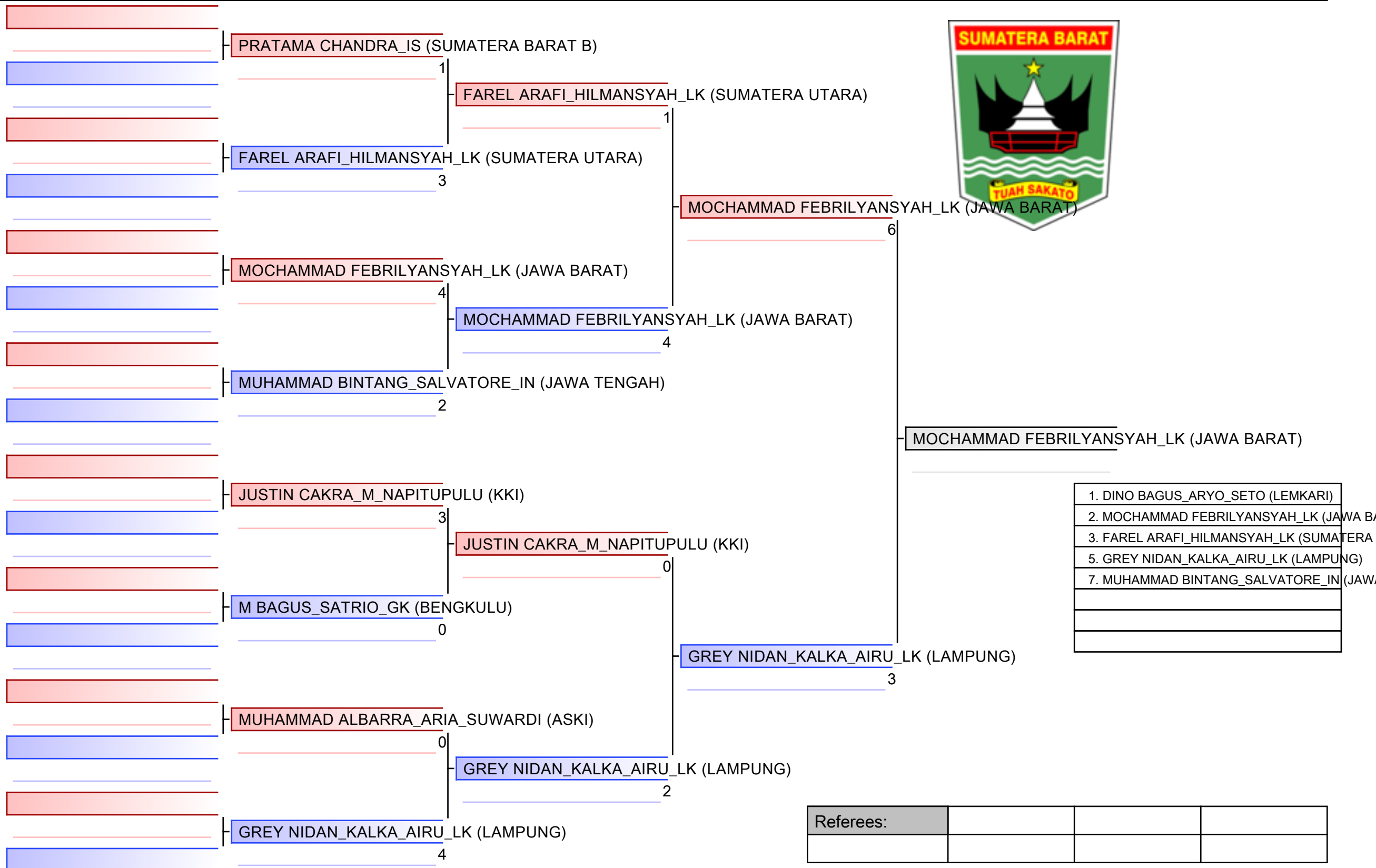

- | |
|--|
| 1. DINO BAGUS_ARYO_SETO (LEMKARI) |
| 2. MOCHAMMAD FEBRILYANSYAH_LK (JAWA BARAT) |
| 3. FAREL ARAFI_HILMANSYAH_LK (SUMATERA UTARA) |
| 5. GREY NIDAN_KALKA_AIRU_LK (LAMPUNG) |
| 7. MUHAMMAD BINTANG_SALVATORE_IN (JAWA TENGAH) |
| |
| |

Referees:			

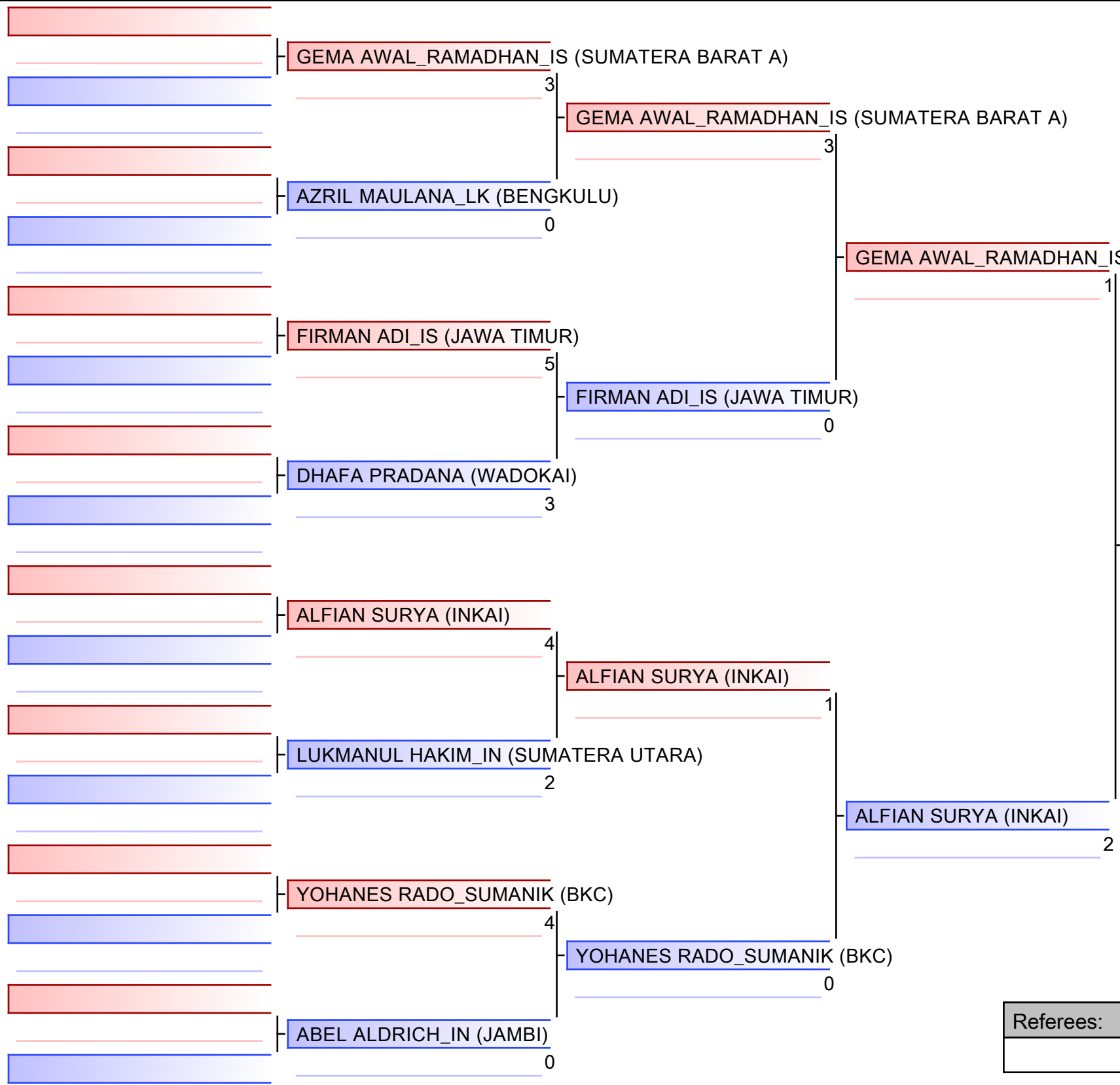

ALFIAN SURYA (INKAI)

- | |
|---|
| 1. ALFIAN SURYA (INKAI) |
| 2. BILLY PASYAH_PURNOMO_BC (JAWA BARAT) |
| 3. RAIHANI IRFANDA (LEMKARI) |
| 3. YOHANES RADO_SUMANIK (BKC) |
| 5. RIFFAT JUHLANSYAH_SOBARI (KKI) |
| 5. GEMA AWAL_RAMADHAN_IS (SUMATERA BARAT A) |
| 7. WINTAMA DIMAS_FIQIH_KI (LAMPUNG) |
| 7. LUKMANUL HAKIM_IN (SUMATERA UTARA) |

Referees:			

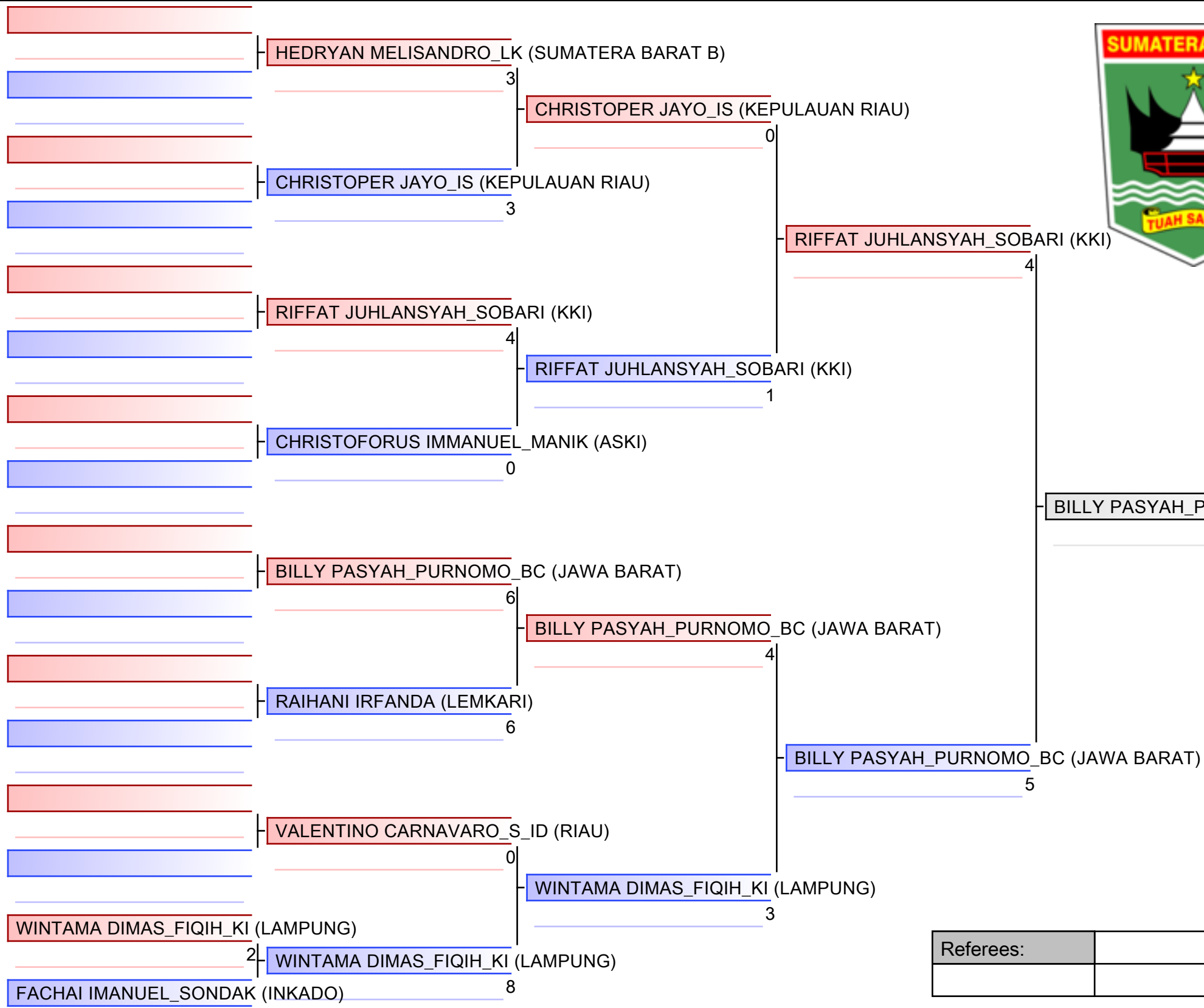

- | |
|---|
| 1. ALFIAN SURYA (INKAI) |
| 2. BILLY PASYAH_PURNOMO_BC (JAWA BARAT) |
| 3. RAIHANI IRFANDA (LEMKARI) |
| 3. YOHANES RADO_SUMANIK (BKC) |
| 5. RIFFAT JUHLANSYAH_SOBARI (KKI) |
| 5. GEMA AWAL_RAMADHAN_IS (SUMATERA BARAT) |
| 7. WINTAMA DIMAS_FIQIH_KI (LAMPUNG) |
| 7. LUKMANUL HAKIM_IN (SUMATERA UTARA) |

Referees:			

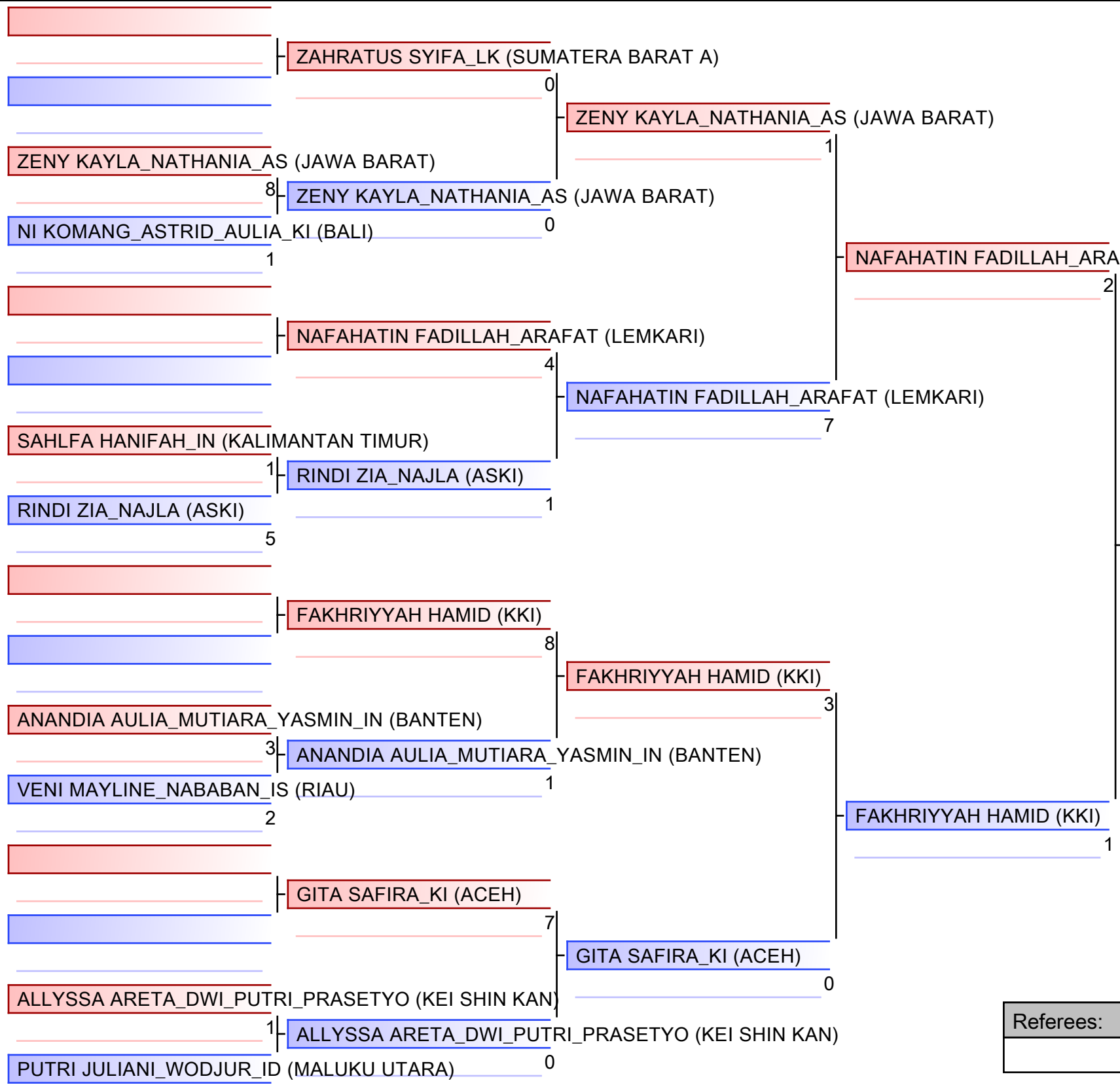

- | |
|---|
| 1. NAFAHATIN FADILLAH_ARAFAT (LEMKARI) |
| 2. GHINA MUFIDA (GOJUKAI) |
| 3. RAHMATIKA DWI_WAHYUNINGRUM (INKAI) |
| 3. FAKHRIYYAH HAMID (KKI) |
| 5. ALODYA VARISSA_KHAWISWARA_BC (JAWA T) |
| 5. ZENY KAYLA_NATHANIA_AS (JAWA BARAT) |
| 7. KURNIA PUTRI_IVANA_IS (SUMATERA BARAT) |
| 7. RINDI ZIA_NAJLA (ASKI) |

Referees:			

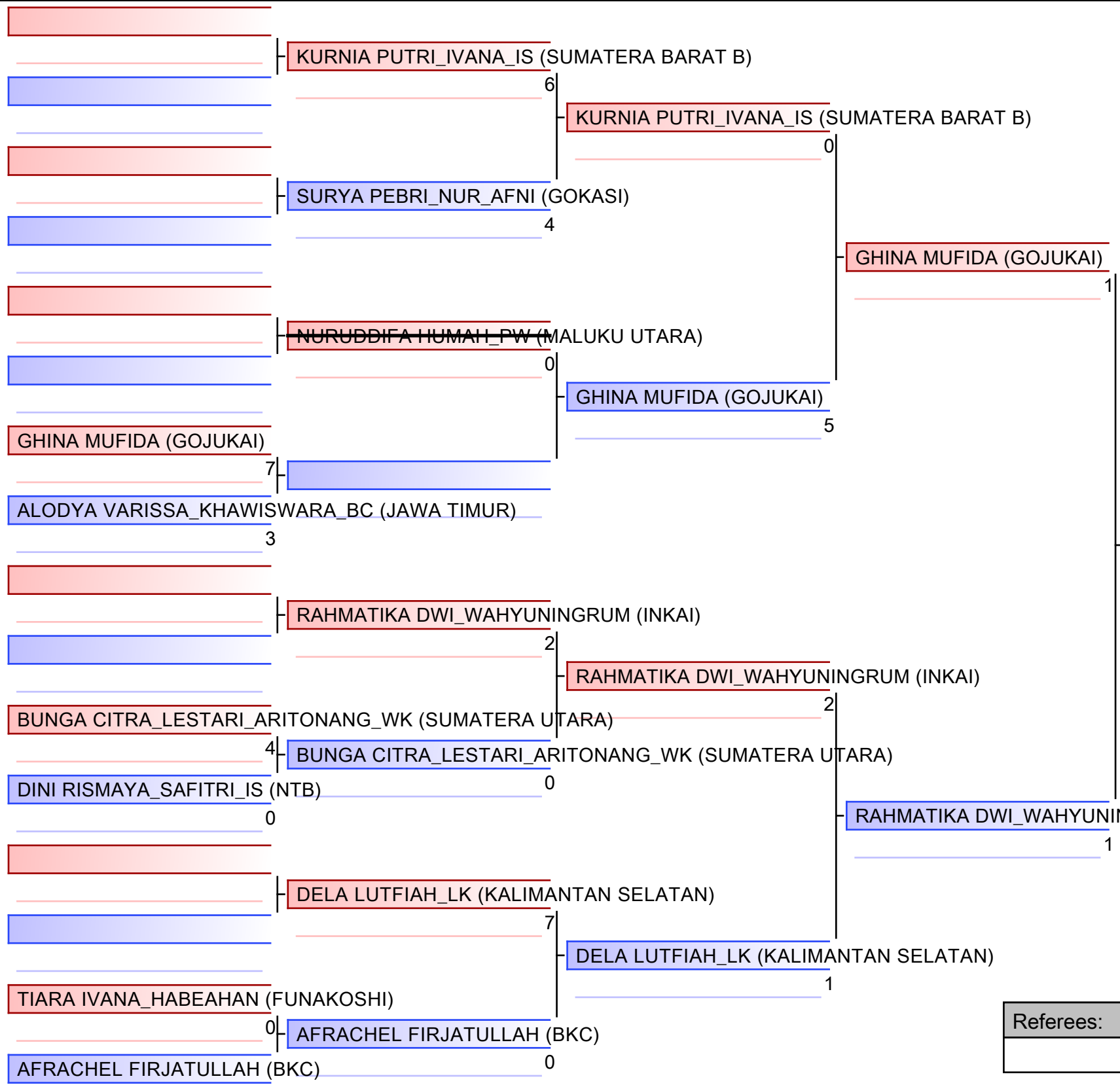

- | |
|---|
| 1. NAFAHATIN FADILLAH_ARAFAT (LEMKARI) |
| 2. GHINA MUFIDA (GOJUKAI) |
| 3. RAHMATIKA DWI_WAHYUNINGRUM (INKAI) |
| 3. FAKHRIYYAH HAMID (KKI) |
| 5. ALODYA VARISSA_KHAWISWARA_BC (JAWA T) |
| 5. ZENY KAYLA_NATHANIA_AS (JAWA BARAT) |
| 7. KURNIA PUTRI_IVANA_IS (SUMATERA BARAT) |
| 7. RINDI ZIA_NAJLA (ASKI) |

Referees:			

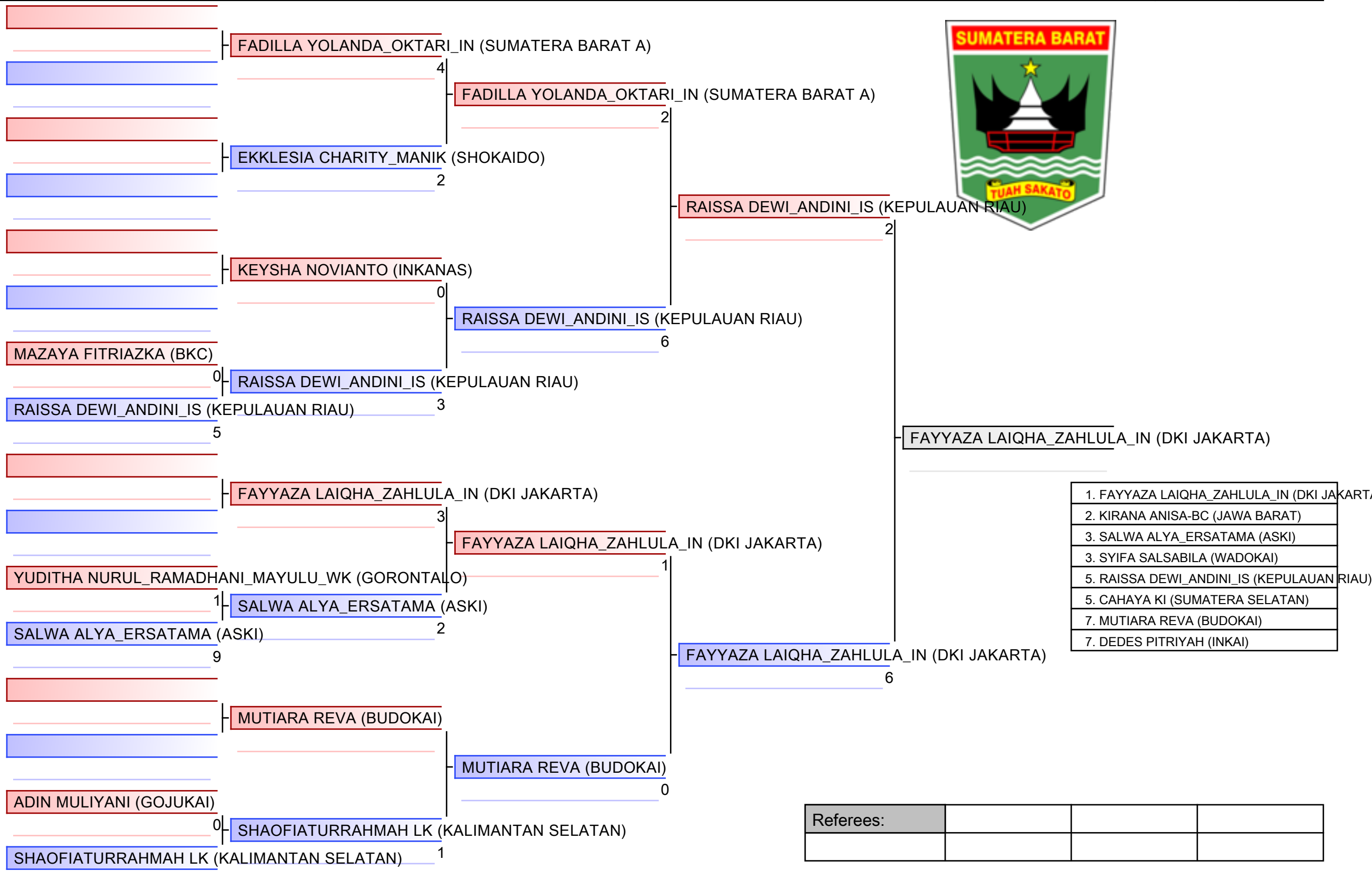

- | |
|--|
| 1. FAYYAZA LAIQHA_ZAHLULA_IN (DKI JAKARTA) |
| 2. KIRANA ANISA-BC (JAWA BARAT) |
| 3. SALWA ALYA_ERSATAMA (ASKI) |
| 3. SYIFA SALSABILA (WADOKAI) |
| 5. RAISSA DEWI_ANDINI_IS (KEPULAUAN RIAU) |
| 5. CAHAYA KI (SUMATERA SELATAN) |
| 7. MUTIARA REVA (BUDOKAI) |
| 7. DEDES PITRIYAH (INKAI) |

Referees:			

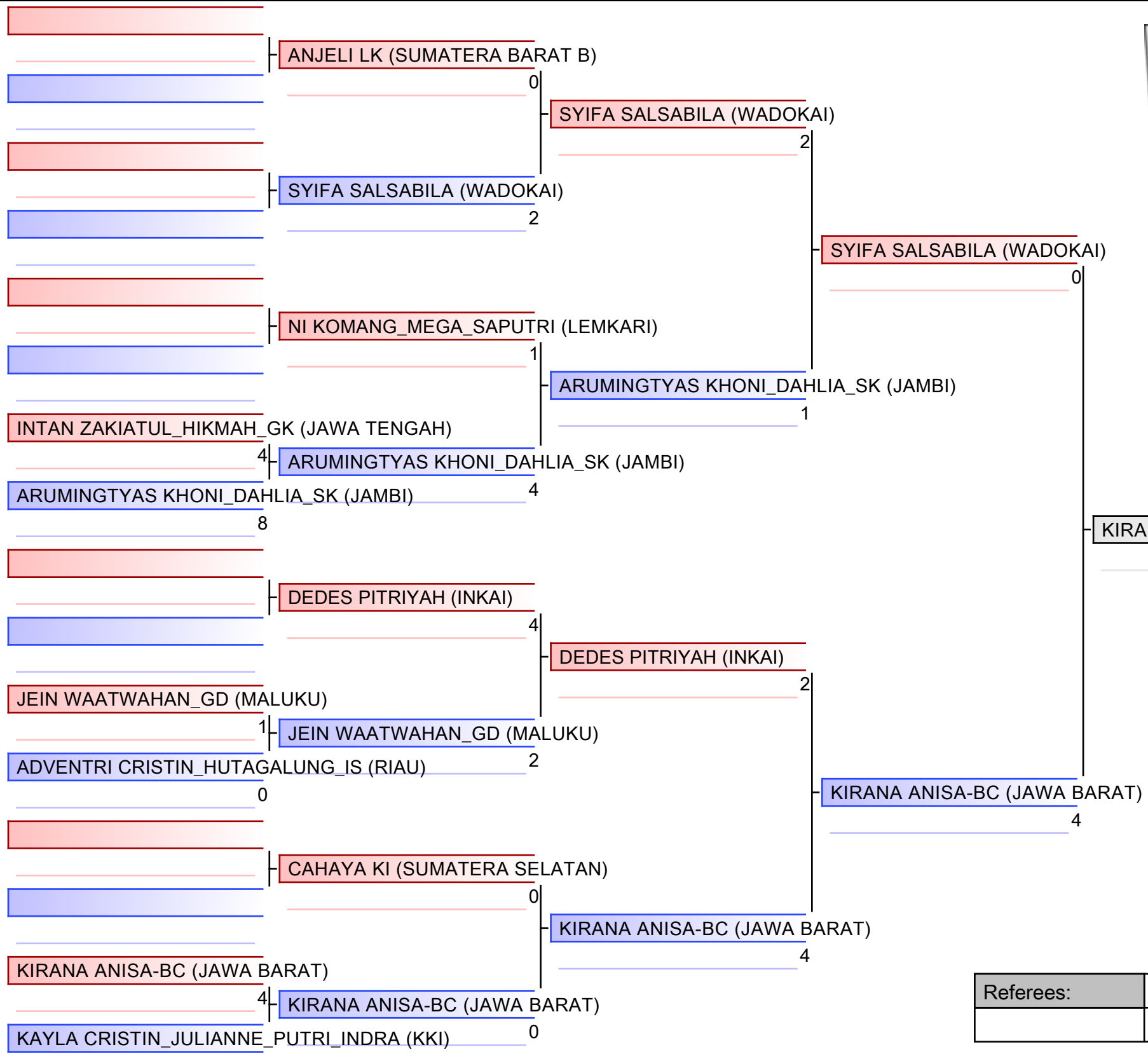

- | |
|--|
| 1. FAYYAZA LAIQHA_ZAHLULA_IN (DKI JAKARTA) |
| 2. KIRANA ANISA-BC (JAWA BARAT) |
| 3. SALWA ALYA_ERSATAMA (ASKI) |
| 3. SYIFA SALSABILA (WADOKAI) |
| 5. RAISSA DEWI_ANDINI_IS (KEPULAUAN RIAU) |
| 5. CAHAYA KI (SUMATERA SELATAN) |
| 7. MUTIARA REVA (BUDOKAI) |
| 7. DEDES PITRIYAH (INKAI) |

Referees:			

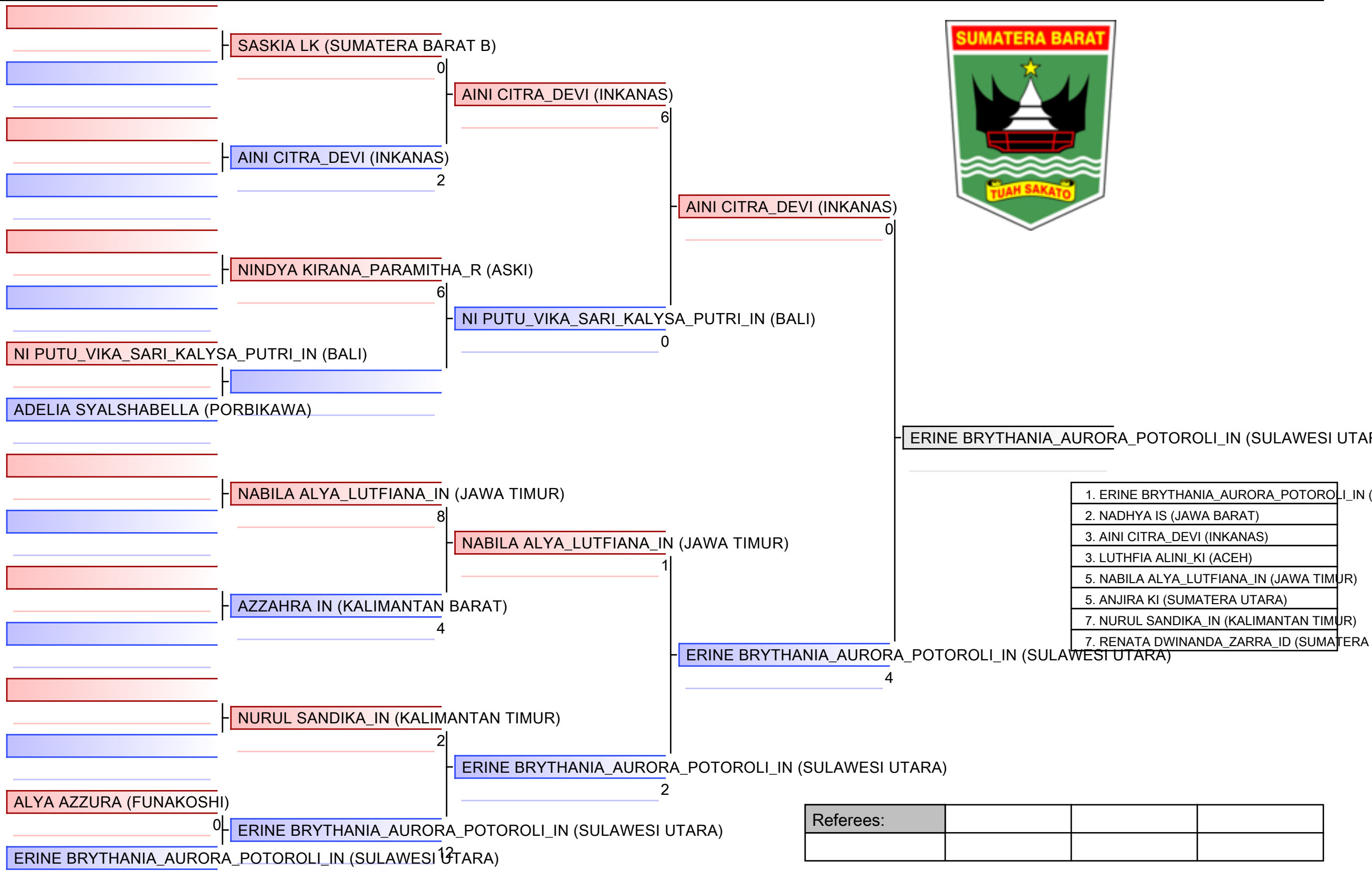

- | |
|--|
| 1. ERINE BRYTHANIA_AURORA_POTOROLI_IN (SULAWESI UTARA) |
| 2. NADHYA IS (JAWA BARAT) |
| 3. AINI CITRA_DEVI (INKANAS) |
| 3. LUTHFIA ALINI_KI (ACEH) |
| 5. NABILA ALYA_LUTFIANA_IN (JAWA TIMUR) |
| 5. ANJIRA KI (SUMATERA UTARA) |
| 7. NURUL SANDIKA_IN (KALIMANTAN TIMUR) |
| 7. RENATA DWINANDA_ZARRA_ID (SUMATERA BARAT) |

Referees:			

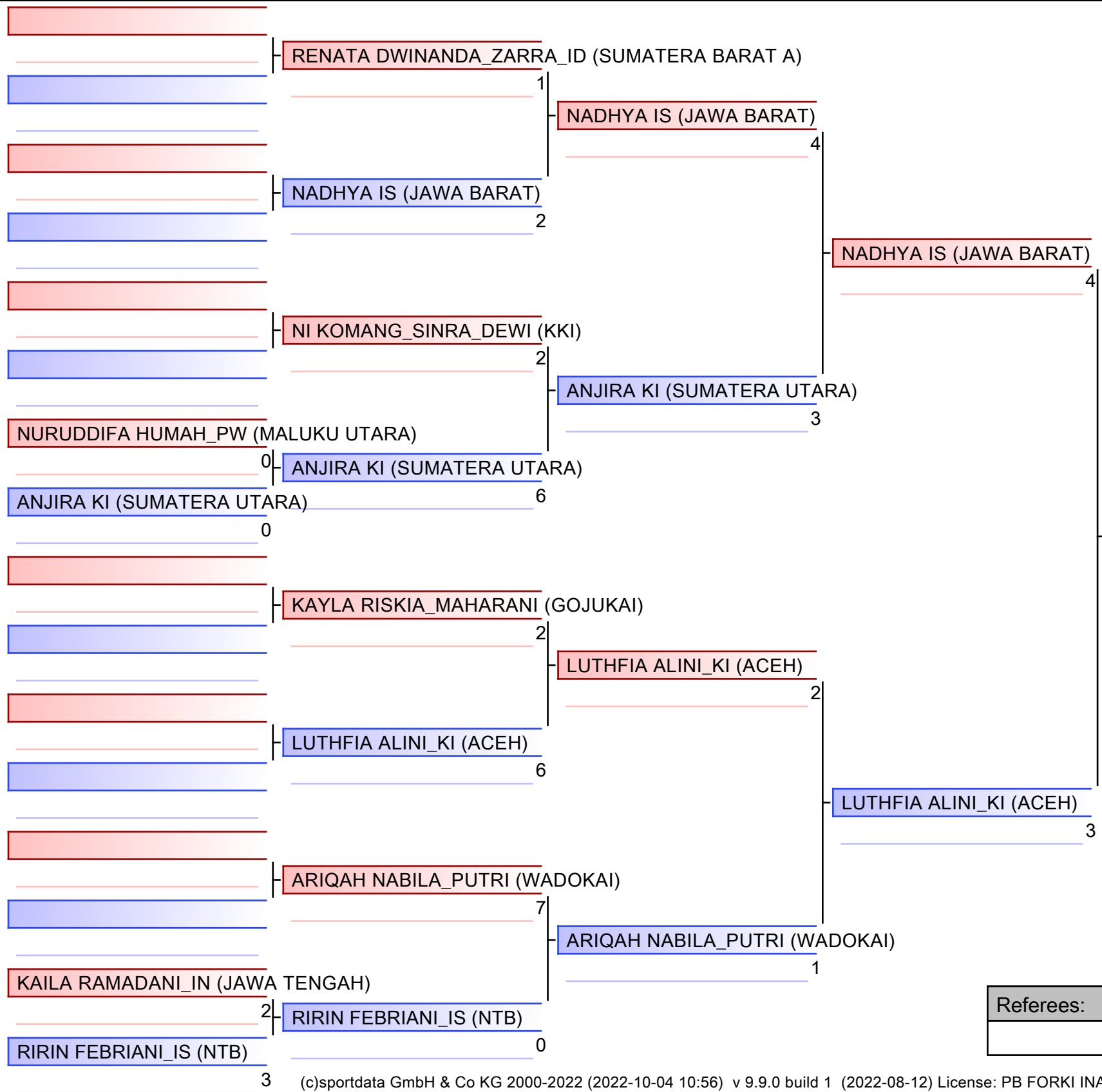

- | |
|---|
| 1. ERINE BRYTHANIA_AURORA_POTOROLI_IN (S) |
| 2. NADHYA IS (JAWA BARAT) |
| 3. AINI CITRA_DEVI (INKANAS) |
| 3. LUTHFIA ALINI_KI (ACEH) |
| 5. NABILA ALYA_LUTFIANA_IN (JAWA TIMUR) |
| 5. ANJIRA KI (SUMATERA UTARA) |
| 7. NURUL SANDIKA_IN (KALIMANTAN TIMUR) |
| 7. RENATA DWINANDA_ZARRA_ID (SUMATERA B) |

Referees:			

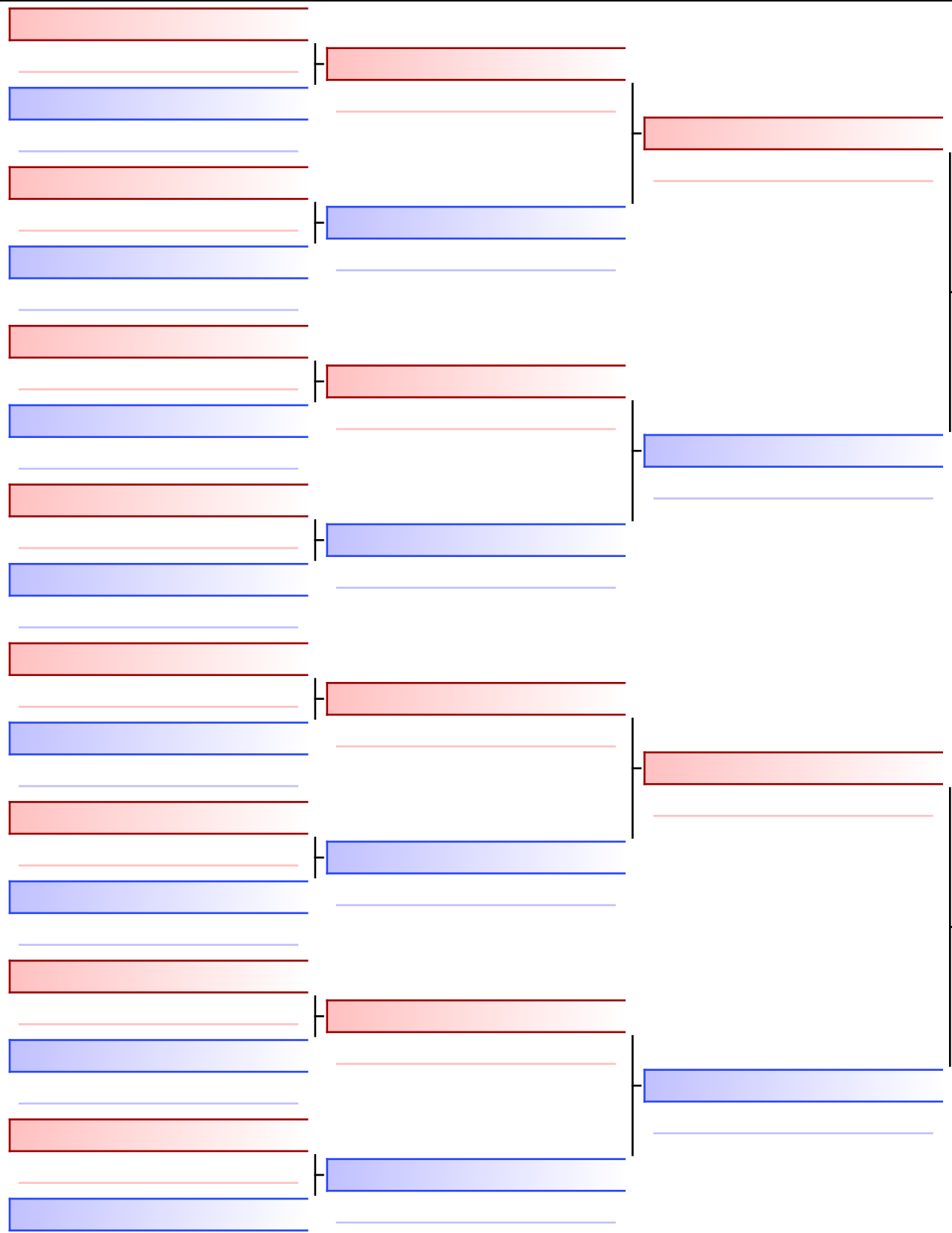

Final

MUHAMMAD PADI_FAUZAN_SYAM (KKI)

5

MUHAMMAD PADI_FAUZAN_SYAM (KKI)

RACKEE BALARAMA (INKAI)

2



- | |
|---|
| 1. MUHAMMAD PADI_FAUZAN_SYAM (KKI) |
| 2. RACKEE BALARAMA (INKAI) |
| 3. AQDAS MIFTAHUL_KASFILLAH (INKANAS) |
| 3. NAUFAL DZAKY_ANSYORI_IS (SUMATERA BARAT) |
| 5. PUJANGGA FITRAH_R_LK (BENGKULU) |
| 5. WIRA SETYA_YUDHA_SO (RIAU) |
| 7. KHAID THORIQ_SYAHBANA_IN (JAWA BARAT) |
| 7. MUHAMMAD FAHRI_BADU_LK (GORONTALO) |

Referees:			

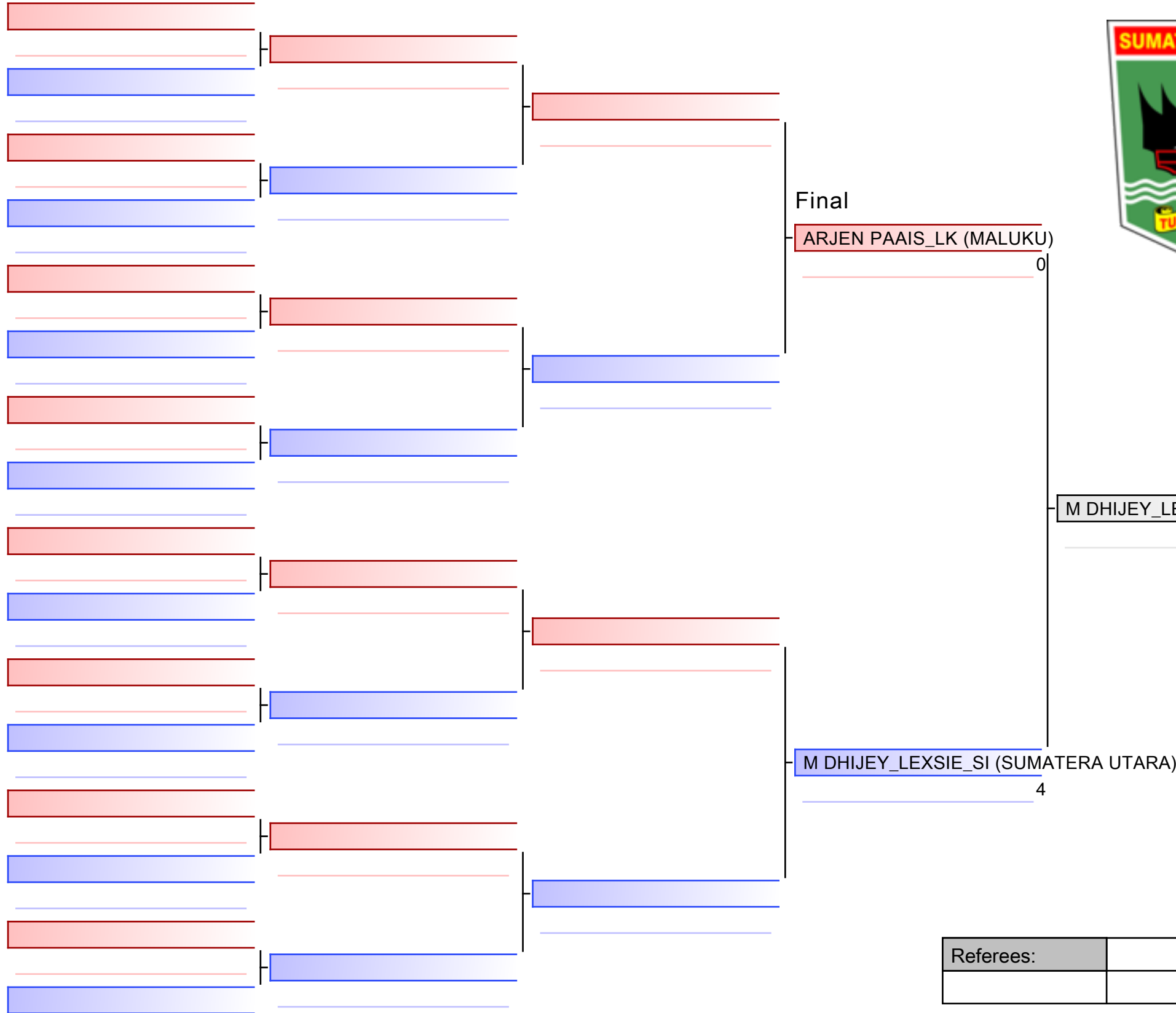

M DHIJEY_LEXSIE_SI (SUMATERA UTARA)

- | |
|---|
| 1. M DHIJEY_LEXSIE_SI (SUMATERA UTARA) |
| 2. ARJEN PAAIS_LK (MALUKU) |
| 3. MADE RYAN_ADITYA_JAYA (KKI) |
| 3. TIO TRIRALY_SAMBENTIRO (WADOKAI) |
| 5. GALANG RIZKI_IS (NTB) |
| 5. TAZKYA PUTRA_MASHUDI-IS (JAWA BARAT) |
| 7. ABDUL HAFIZ_AGIL_FIRDAUS (ASKI) |
| 7. KOMANG TRI_WIDHIARDIKA (LEMKARI) |

Referees:			

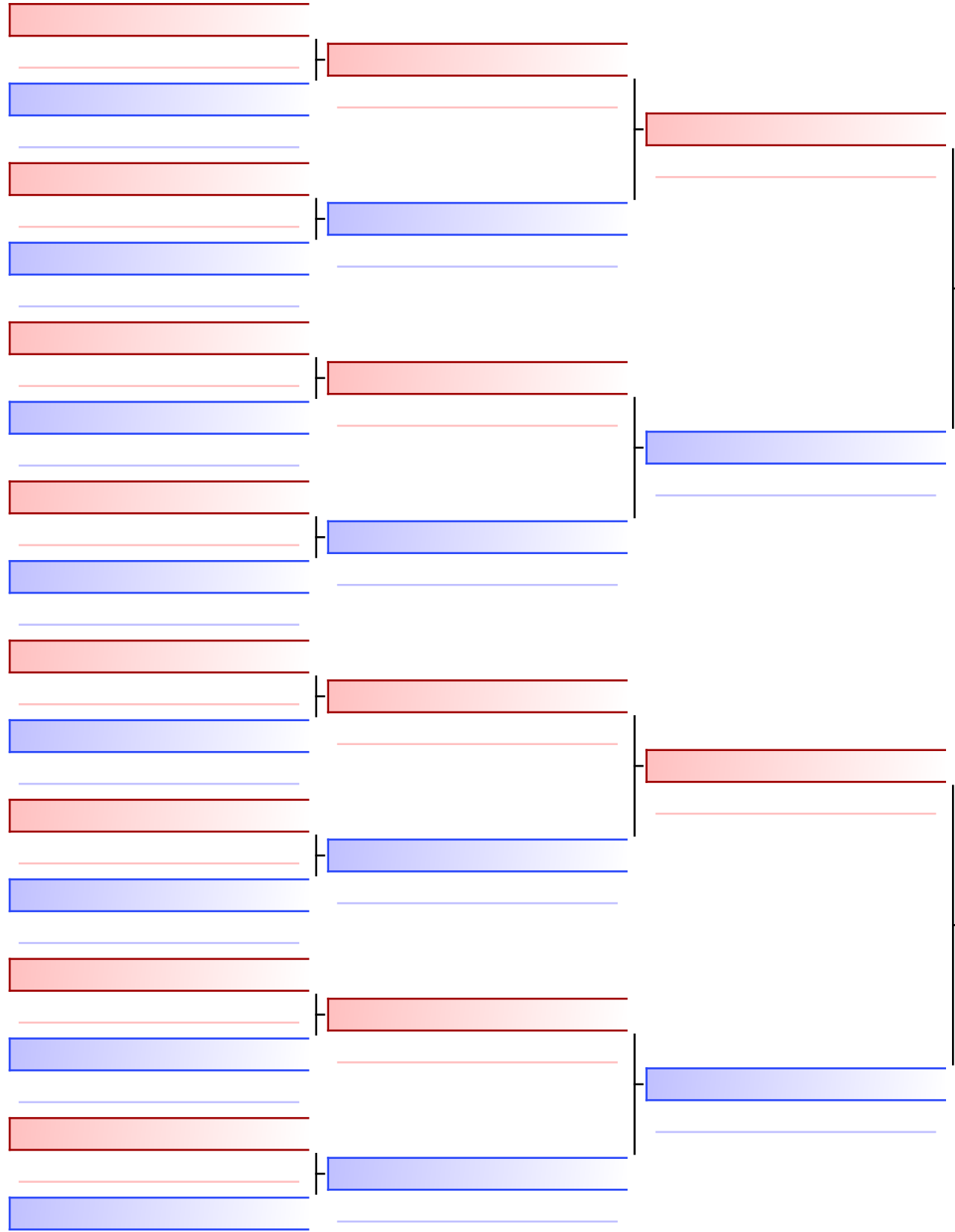

Final

YANUR SYAFA`AT_SABILILLAH_IN (JAWA TIMUR)

2

I KADEK_ANGGA_PRADITA_LK (BALI)

I KADEK_ANGGA_PRADITA_LK (BALI)

3

- | |
|--|
| 1. I KADEK_ANGGA_PRADITA_LK (BALI) |
| 2. YANUR SYAFA`AT_SABILILLAH_IN (JAWA TIMUR) |
| 3. FAHREL APRIANSYAH_AMARTHA_KI (LAMPUNG) |
| 3. AURIGA ARYASATYA_MULYANTO_AS (JAWA T) |
| 5. RAJA MUHAMMAD_ZAKI_IS (SUMATERA BARA) |
| 5. SATRYO ARYA_PUTRA (INKAI) |
| 7. M LANTANG_DINANBANA_LUTHAN (GOJUKAI) |
| 7. SOFYAN HAFIFI_IS (NTB) |

Referees:			

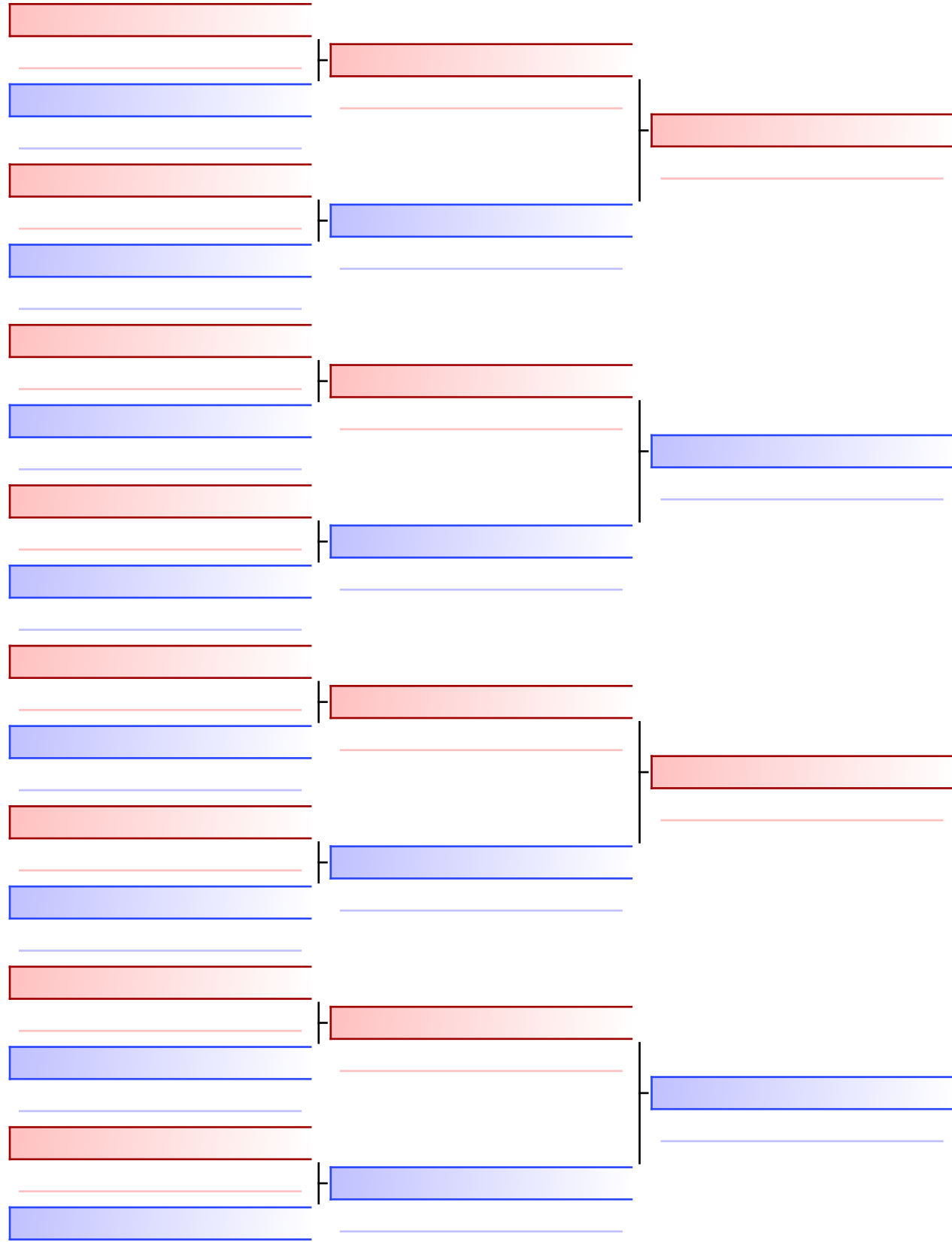

Final

MOCHAMMAD FEBRILYANSYAH_LK (JAWA BARAT)

1

DINO BAGUS_ARYO_SETO (LEMKARI)

DINO BAGUS_ARYO_SETO (LEMKARI)

2

- | |
|--|
| 1. DINO BAGUS_ARYO_SETO (LEMKARI) |
| 2. MOCHAMMAD FEBRILYANSYAH_LK (JAWA BARAT) |
| 3. FAREL ARAFI_HILMANSYAH_LK (SUMATERA UTARA) |
| 5. GREY NIDAN_KALKA_AIRU_LK (LAMPUNG) |
| 7. MUHAMMAD BINTANG_SALVATORE_INI (JAWA BARAT) |
| |
| |
| |

Referees:			

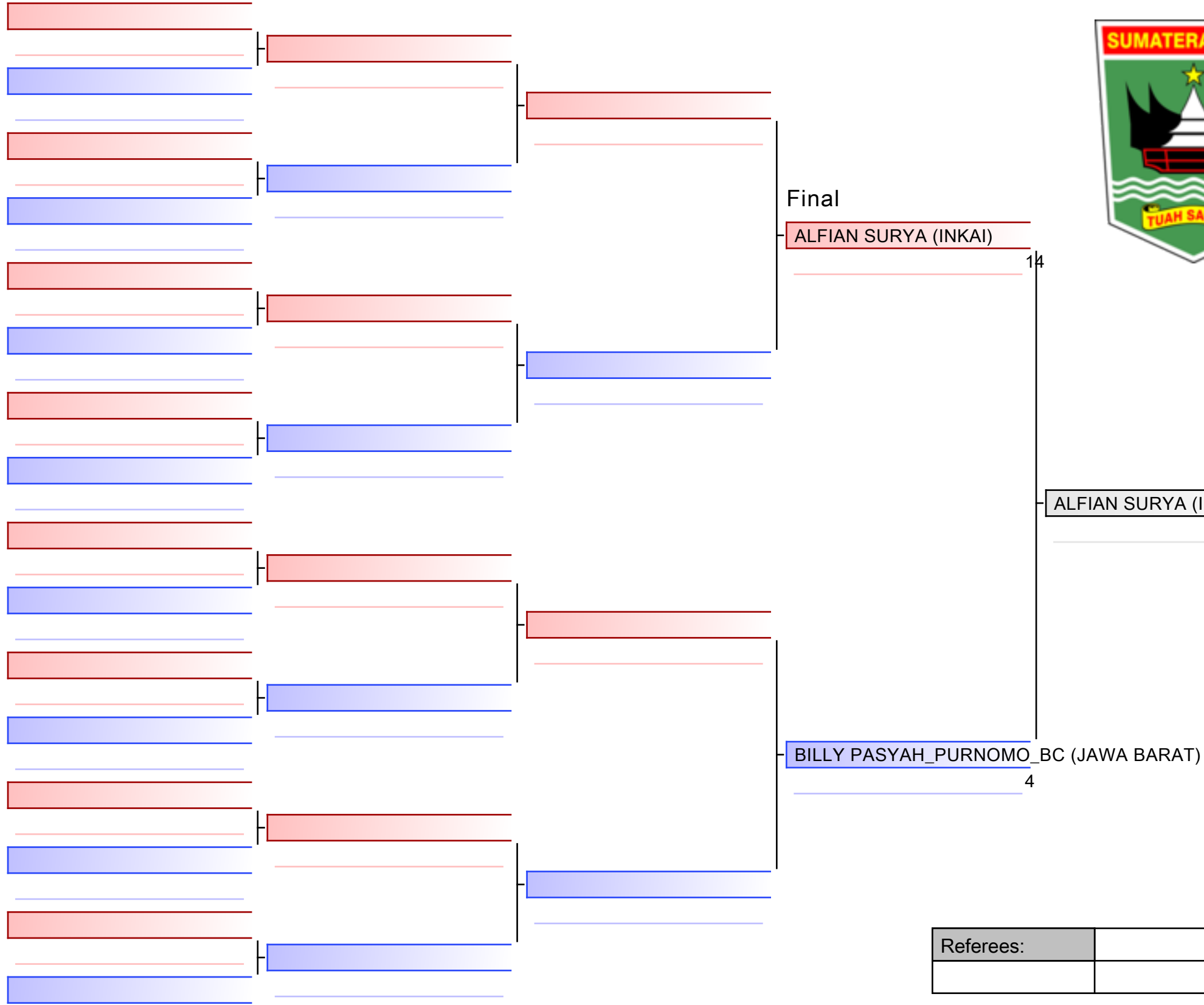

ALFIAN SURYA (INKAI)

- | |
|---|
| 1. ALFIAN SURYA (INKAI) |
| 2. BILLY PASYAH_PURNOMO_BC (JAWA BARAT) |
| 3. RAIHANI IRFANDA (LEMKARI) |
| 3. YOHANES RADO_SUMANIK (BKC) |
| 5. RIFFAT JUHLANSYAH_SOBARI (KKI) |
| 5. GEMA AWAL_RAMADHAN_IS (SUMATERA BAR) |
| 7. WINTAMA DIMAS_FIQIH_KI (LAMPUNG) |
| 7. LUKMANUL HAKIM_IN (SUMATERA UTARA) |

Referees:			

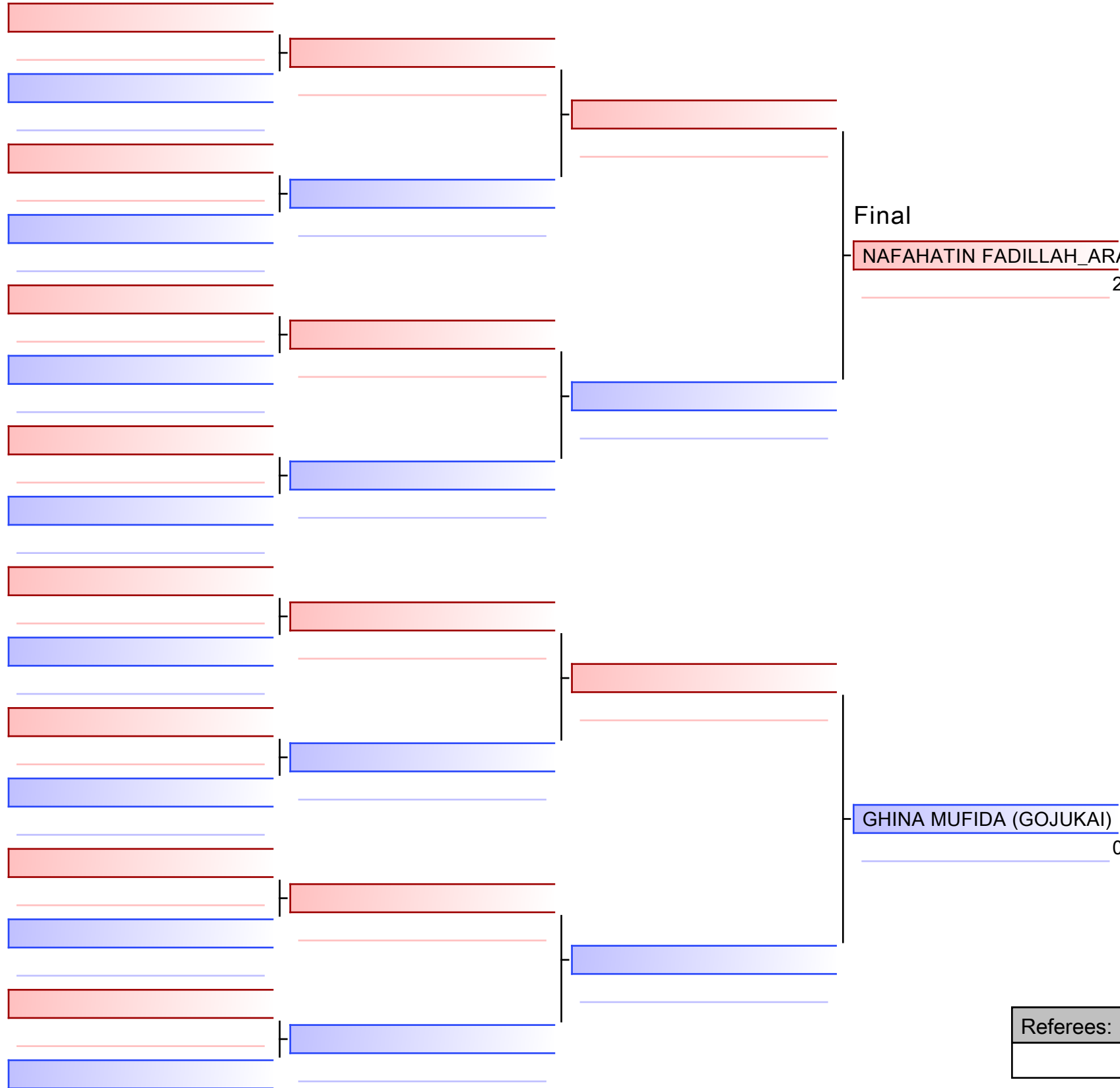

Final

NAFAHATIN FADILLAH_ARAFAT (LEMKARI)

2

NAFAHATIN FADILLAH_ARAFAT (LEMKARI)

GHINA MUFIDA (GOJUKAI)

0

- | |
|---|
| 1. NAFAHATIN FADILLAH_ARAFAT (LEMKARI) |
| 2. GHINA MUFIDA (GOJUKAI) |
| 3. RAHMATIKA DWI_WAHYUNINGRUM (INKAI) |
| 3. FAKHRIYYAH HAMID (KKI) |
| 5. ALODYA VARISSA_KHAWISWARA_BC (JAWA T) |
| 5. ZENY KAYLA_NATHANIA_AS (JAWA BARAT) |
| 7. KURNIA PUTRI_IVANA_IS (SUMATERA BARAT) |
| 7. RINDI ZIA_NAJLA (ASKI) |

Referees:			

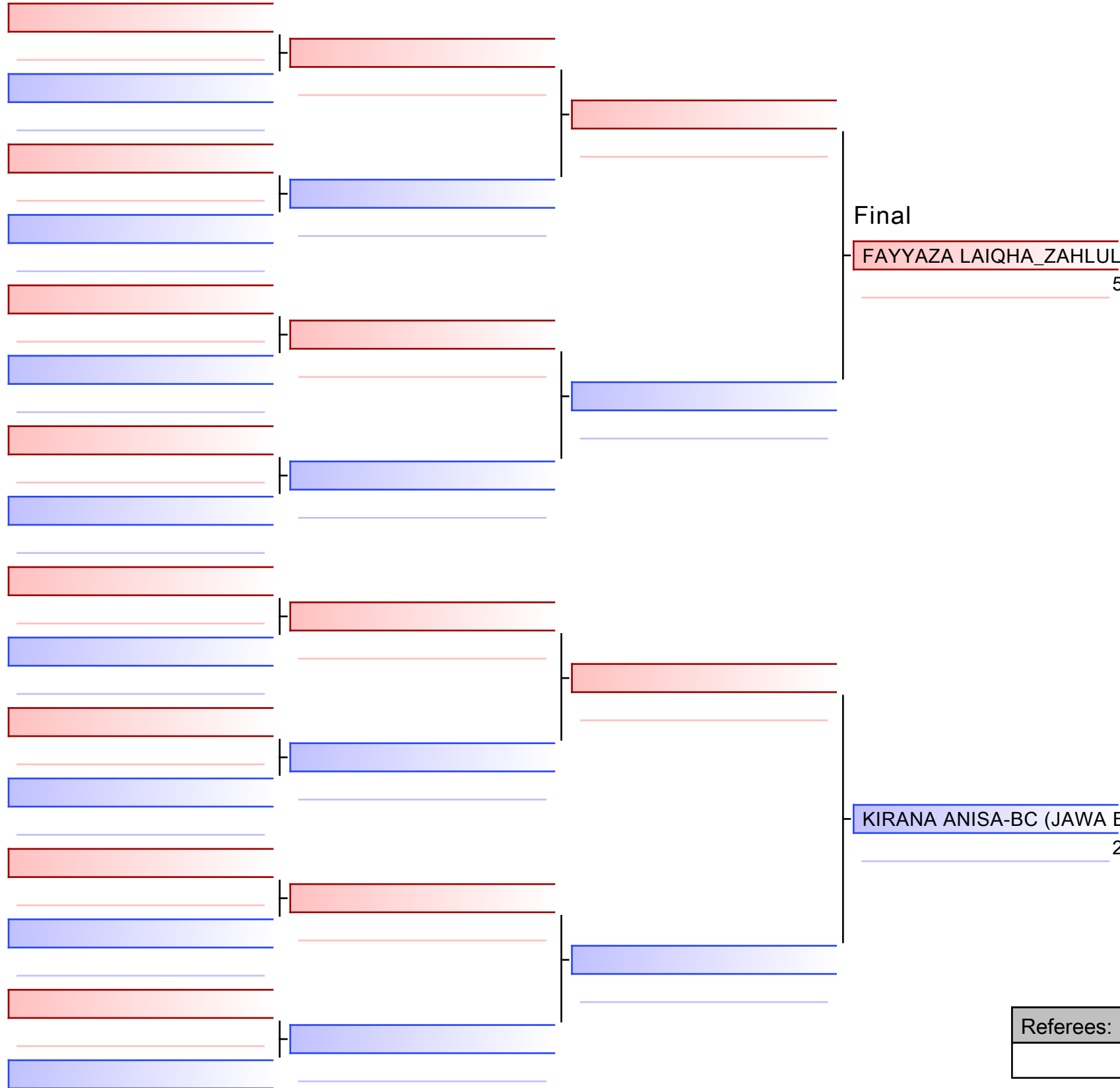

FAYYAZA LAIQHA_ZAHLULA_IN (DKI JAKARTA)

KIRANA ANISA-BC (JAWA BARAT)

- | |
|--|
| 1. FAYYAZA LAIQHA_ZAHLULA_IN (DKI JAKARTA) |
| 2. KIRANA ANISA-BC (JAWA BARAT) |
| 3. SALWA ALYA_ERSATAMA (ASKI) |
| 3. SYIFA SALSABILA (WADOKAI) |
| 5. RAISSA DEWI_ANDINI_IS (KEPULAUAN RIAU) |
| 5. CAHAYA KI (SUMATERA SELATAN) |
| 7. MUTIARA REVA (BUDOKAI) |
| 7. DEDES PITRIYAH (INKAI) |

Referees:			

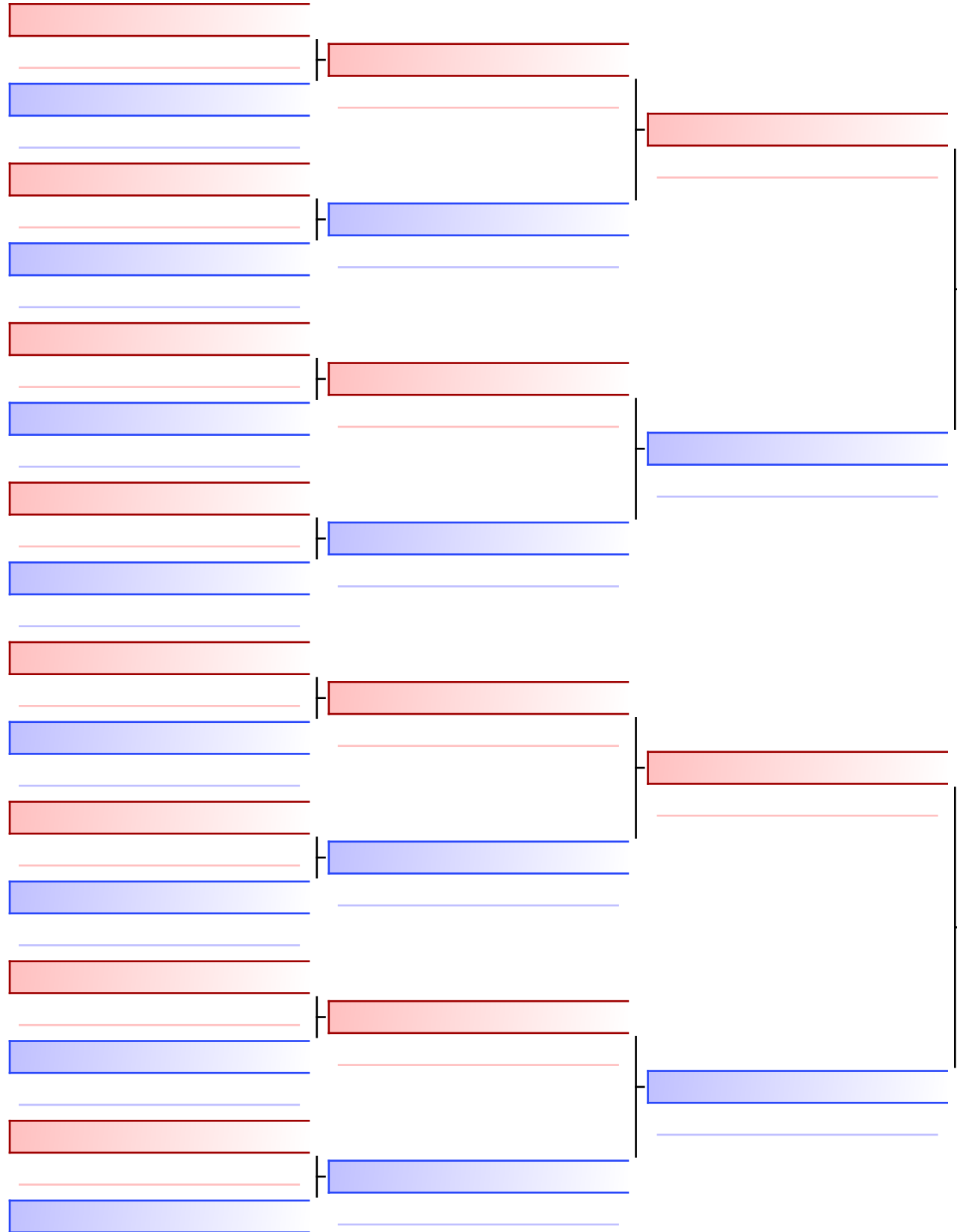

Final

ERINE BRYTHANIA_AURORA_POTOROLI_IN (SULAWESI UTARA)

4

ERINE BRYTHANIA_AURORA_POTOROLI_IN (SULAWESI UTARA)

NADHYA IS (JAWA BARAT)

1



- | |
|--|
| 1. ERINE BRYTHANIA_AURORA_POTOROLI_IN (SULAWESI UTARA) |
| 2. NADHYA IS (JAWA BARAT) |
| 3. AINI CITRA_DEVI (INKANAS) |
| 3. LUTHFIA ALINI_KI (ACEH) |
| 5. NABILA ALYA_LUTFIANA_IN (JAWA TIMUR) |
| 5. ANJIRA KI (SUMATERA UTARA) |
| 7. NURUL SANDIKA_IN (KALIMANTAN TIMUR) |
| 7. RENATA DWINANDA_ZARRA_ID (SUMATERA BARAT) |

Referees:			

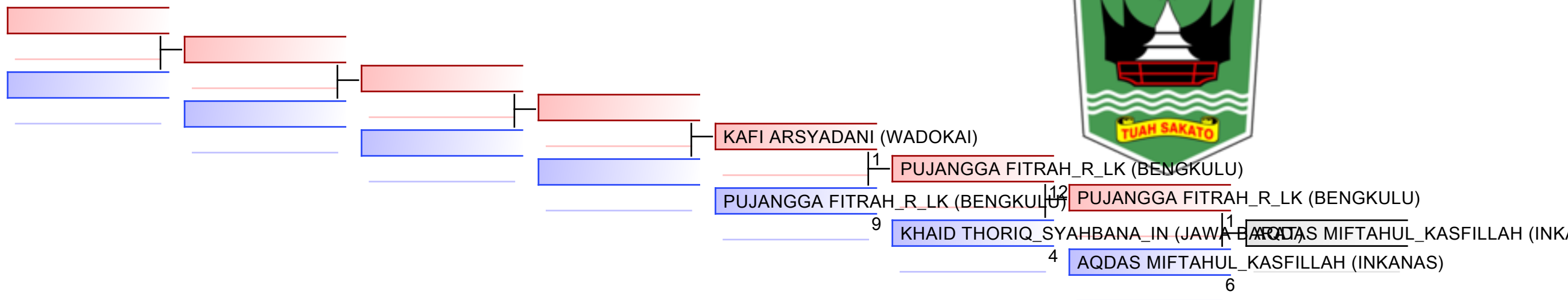

REPECHAGE: (1)

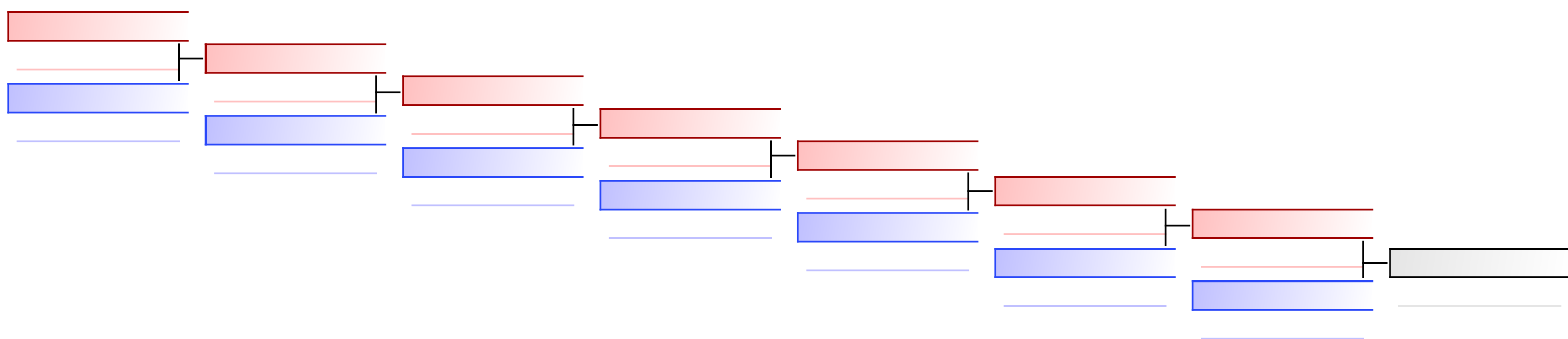

Referees:							
-----------	--	--	--	--	--	--	--

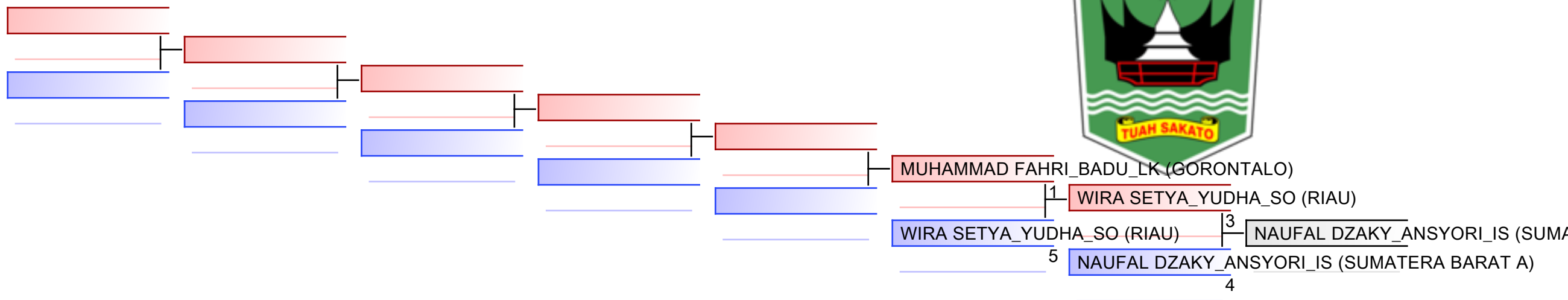

REPECHAGE: (2)

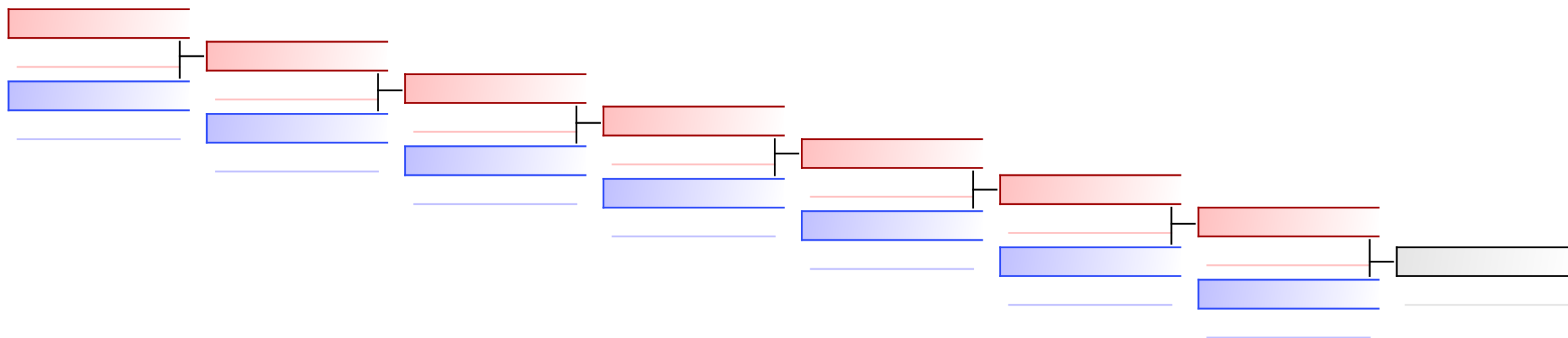

Referees:							
-----------	--	--	--	--	--	--	--

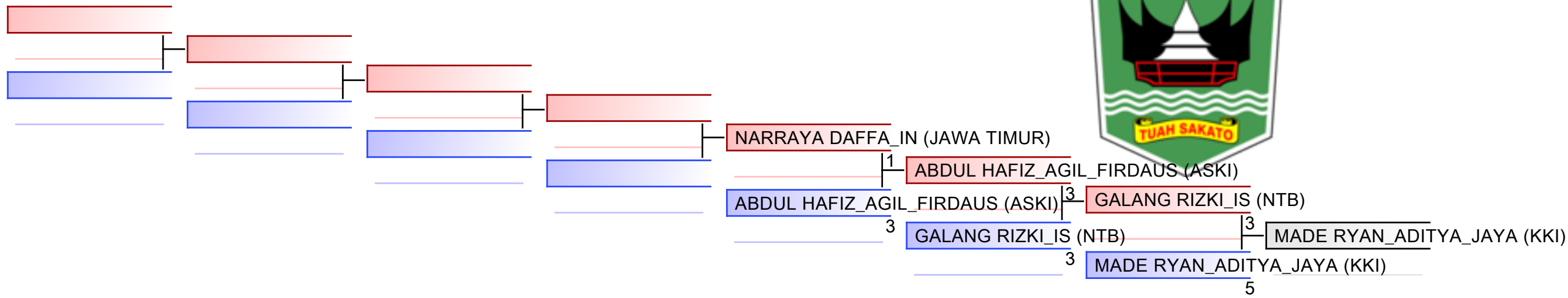

REPECHAGE: (1)

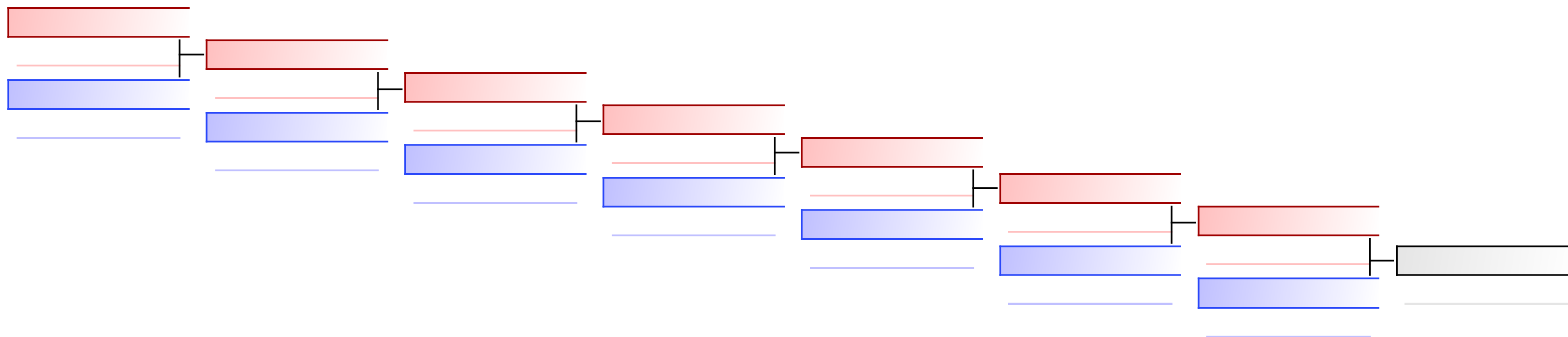

Referees:							
-----------	--	--	--	--	--	--	--

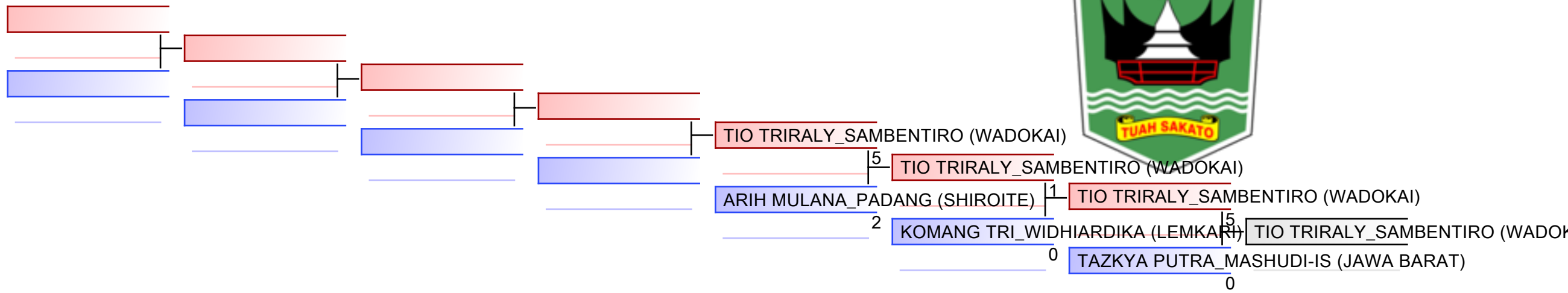

REPECHAGE: (2)

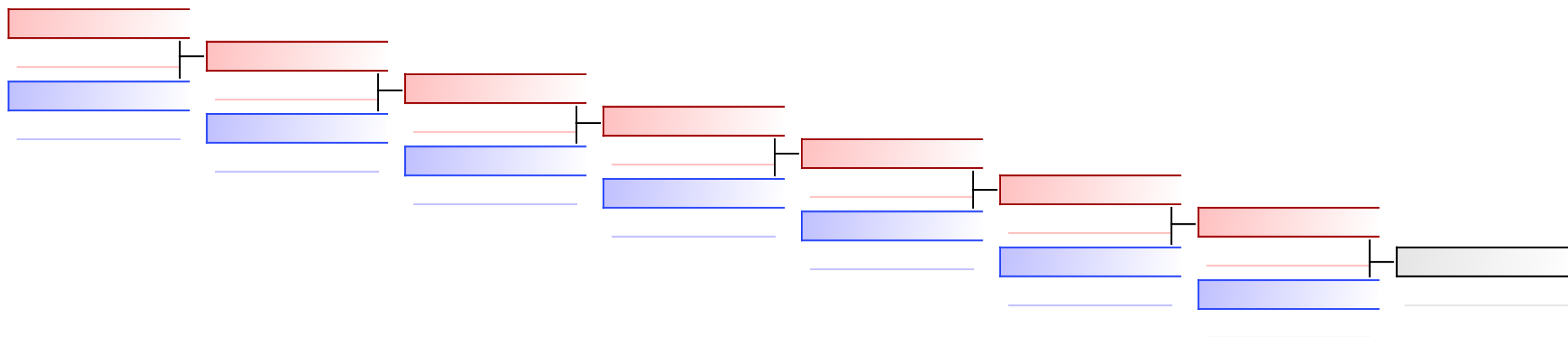

Referees:							
-----------	--	--	--	--	--	--	--

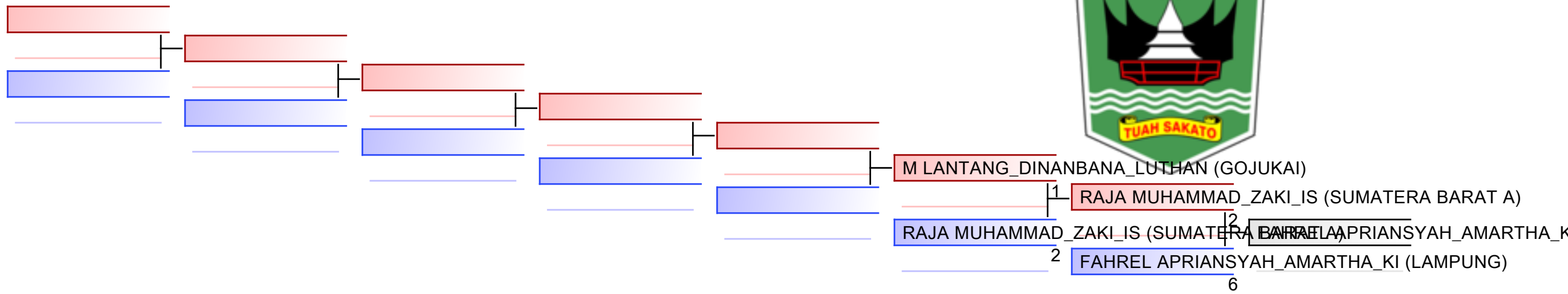

REPECHAGE: (1)

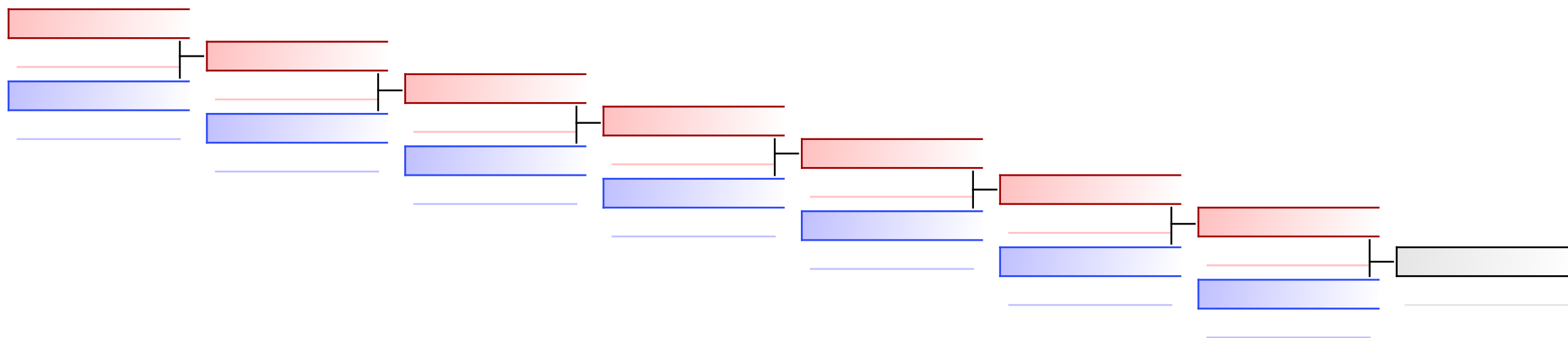

Referees:							
-----------	--	--	--	--	--	--	--

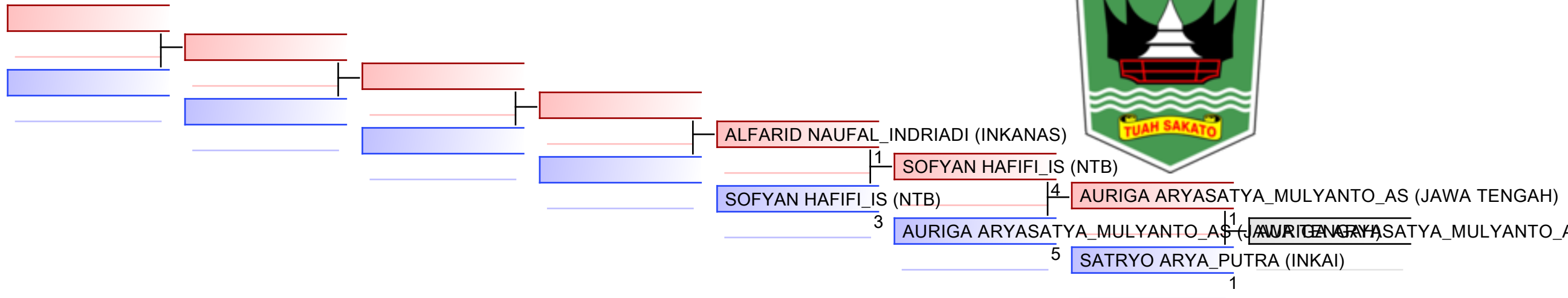

REPECHAGE: (2)

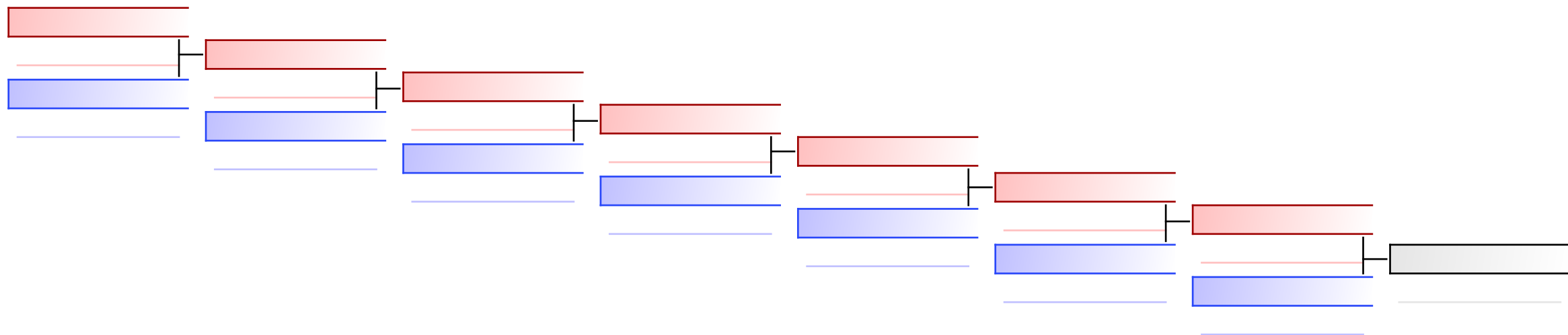

Referees:							
-----------	--	--	--	--	--	--	--

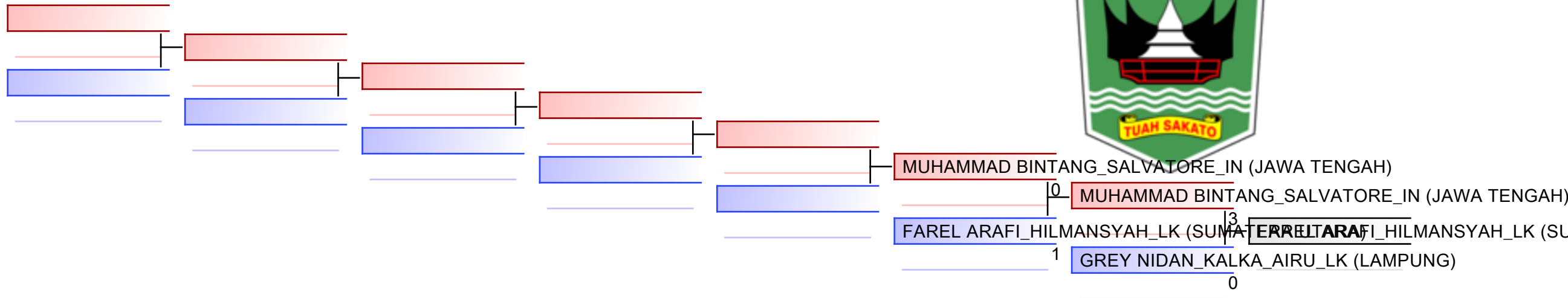

REPECHAGE: (1)

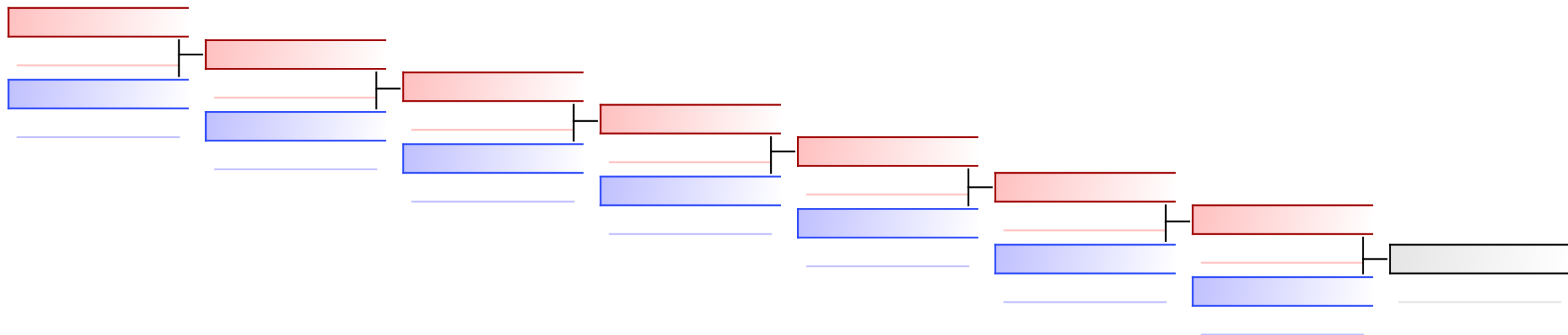

Referees:							
-----------	--	--	--	--	--	--	--

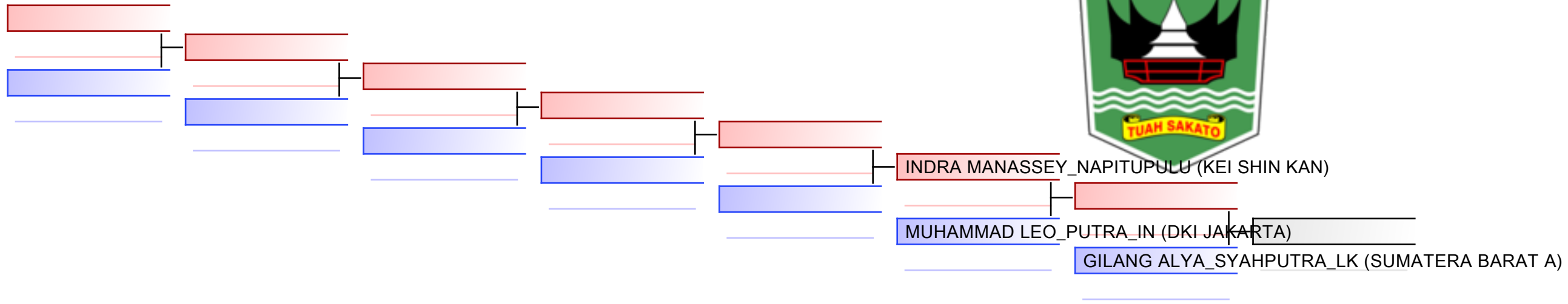

REPECHAGE: (2)

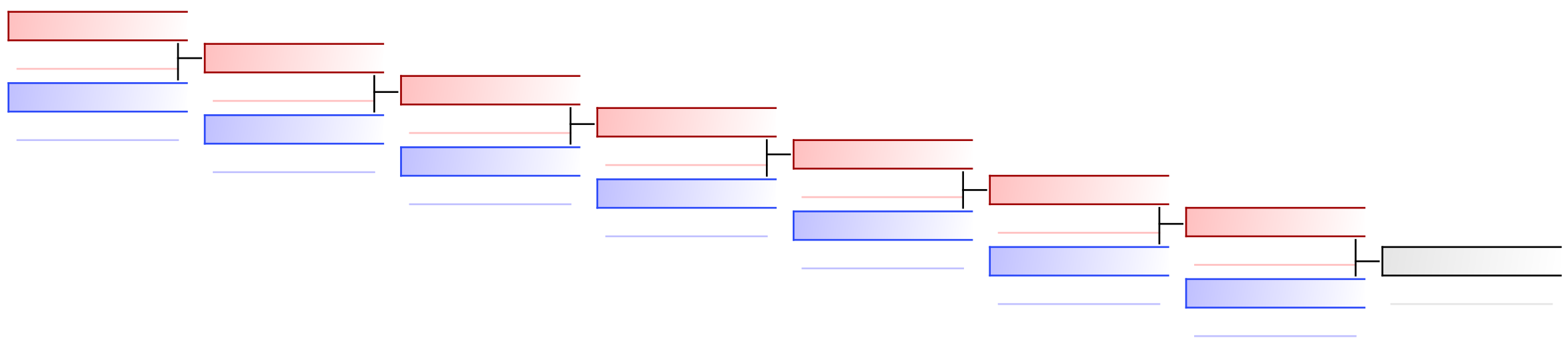

Referees:							
-----------	--	--	--	--	--	--	--

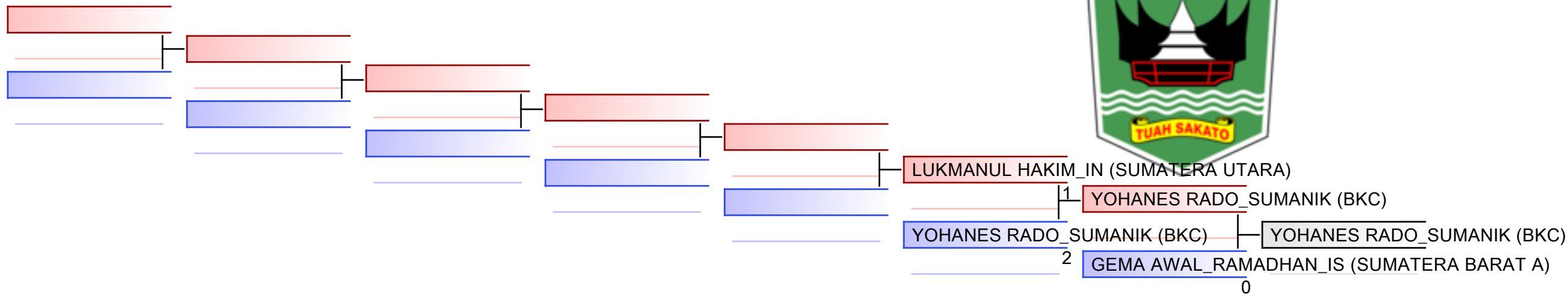

REPECHAGE: (1)

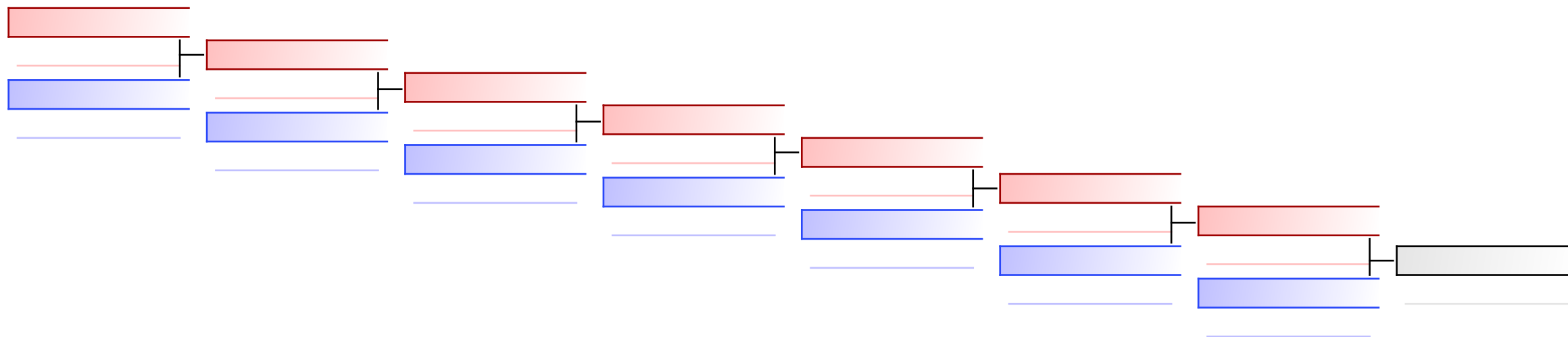

Referees:							
-----------	--	--	--	--	--	--	--

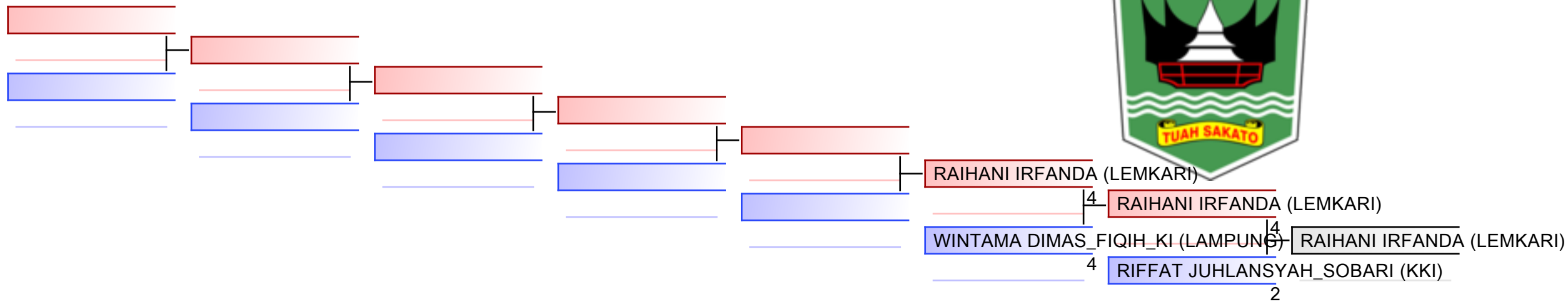

REPECHAGE: (2)

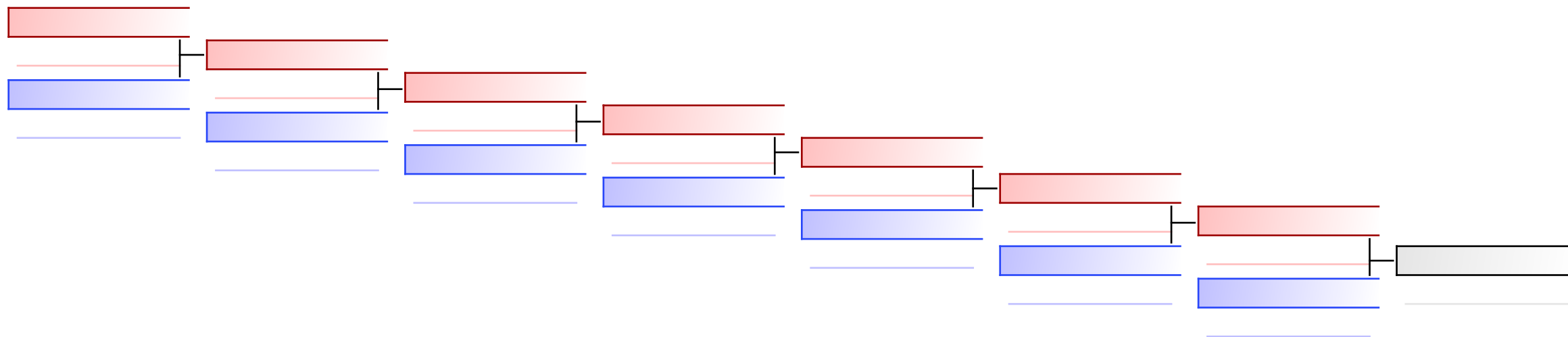

Referees:							
-----------	--	--	--	--	--	--	--

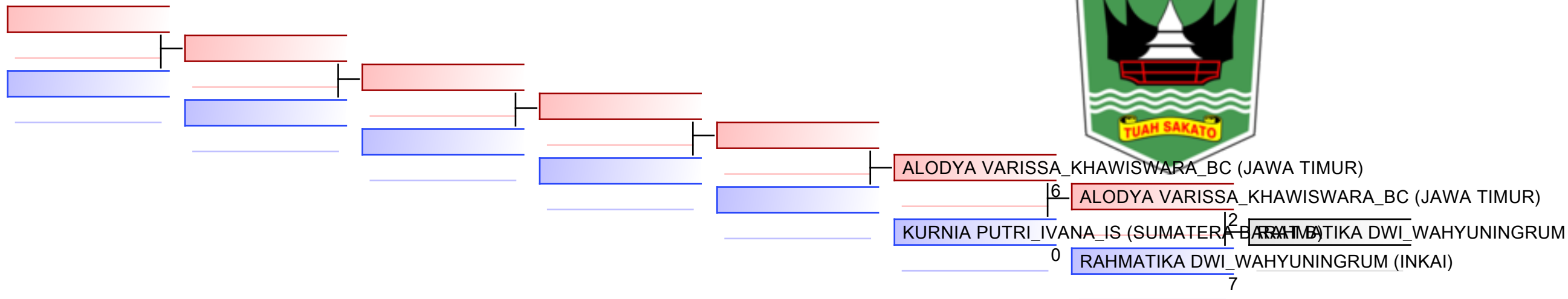

REPECHAGE: (2)

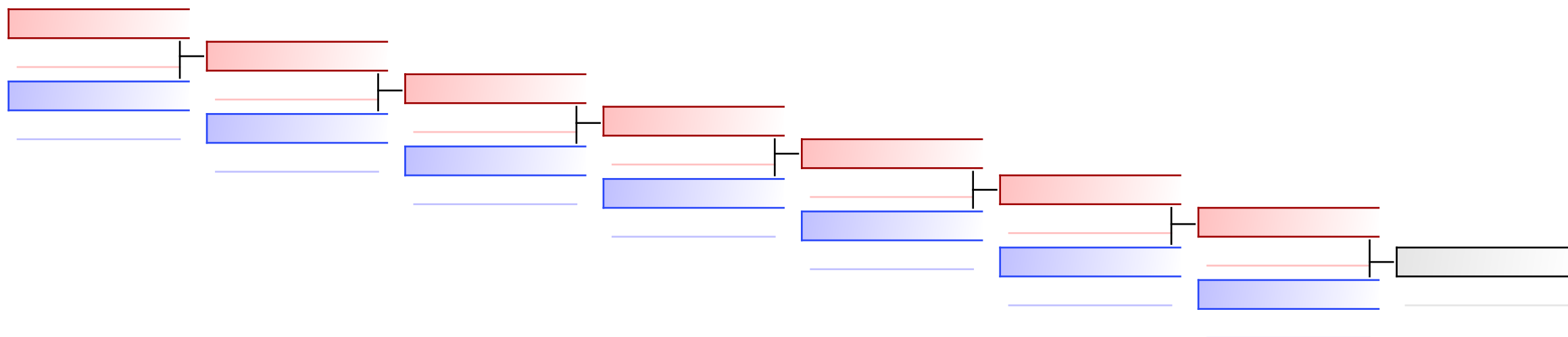

Referees:							
-----------	--	--	--	--	--	--	--

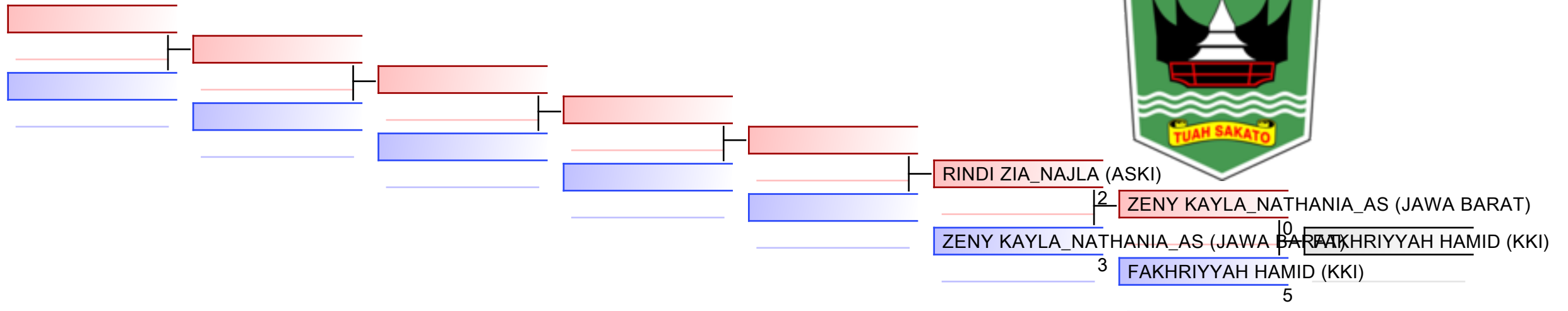

REPECHAGE: (1)

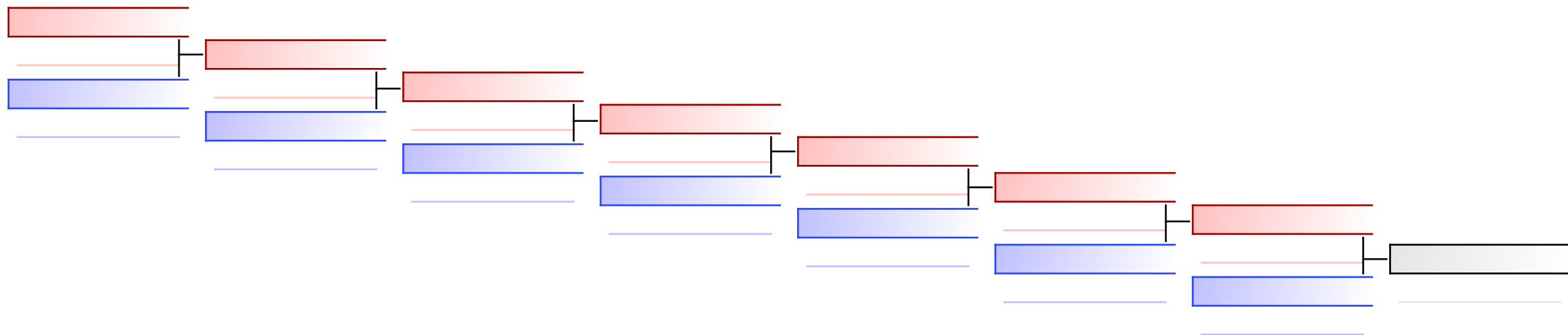

Referees:							
-----------	--	--	--	--	--	--	--

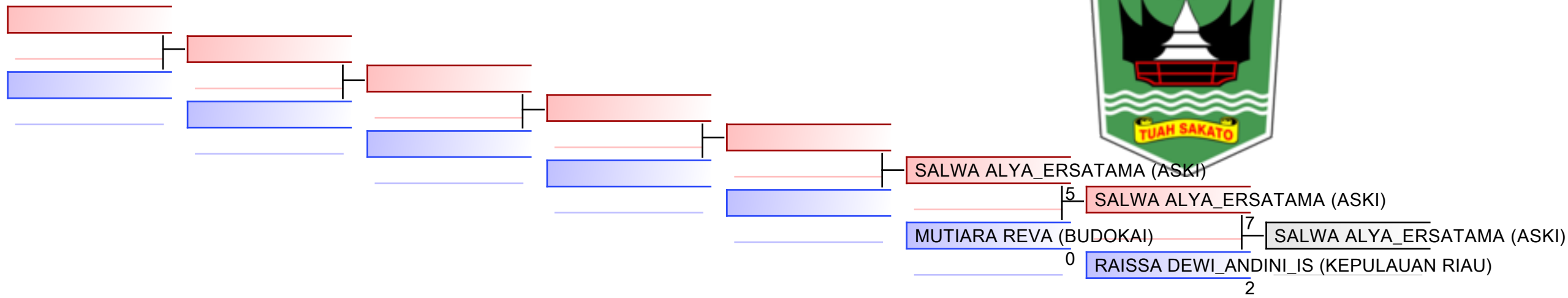

REPECHAGE: (1)

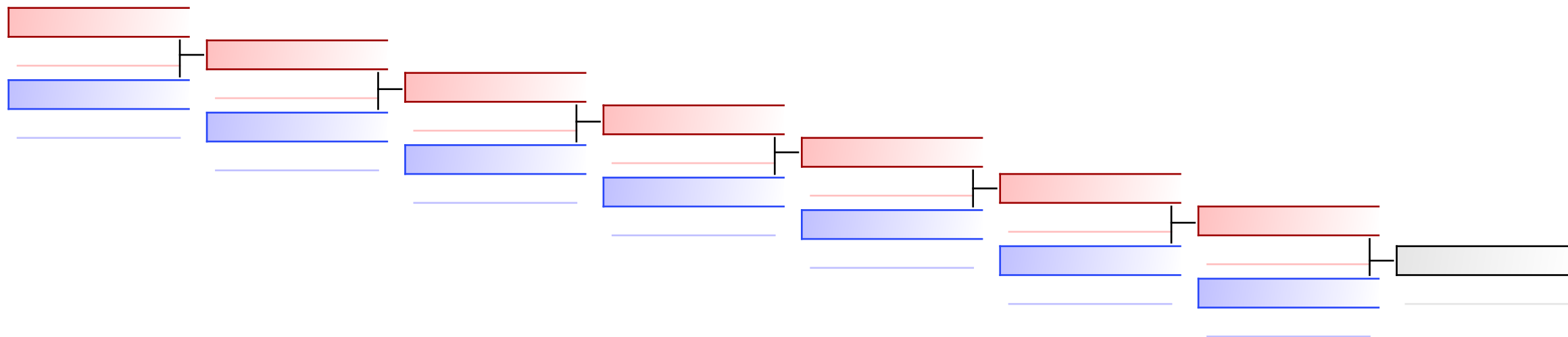

Referees:							
-----------	--	--	--	--	--	--	--

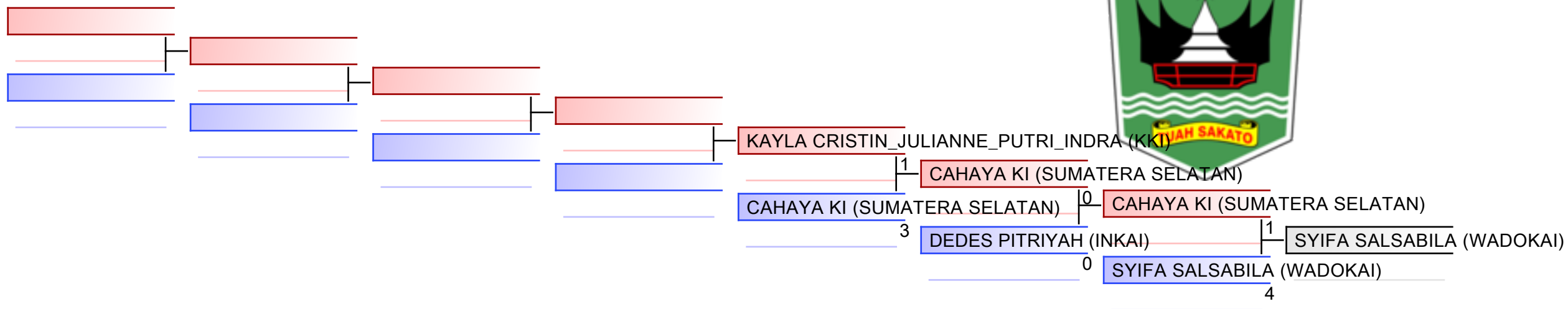

REPECHAGE: (2)

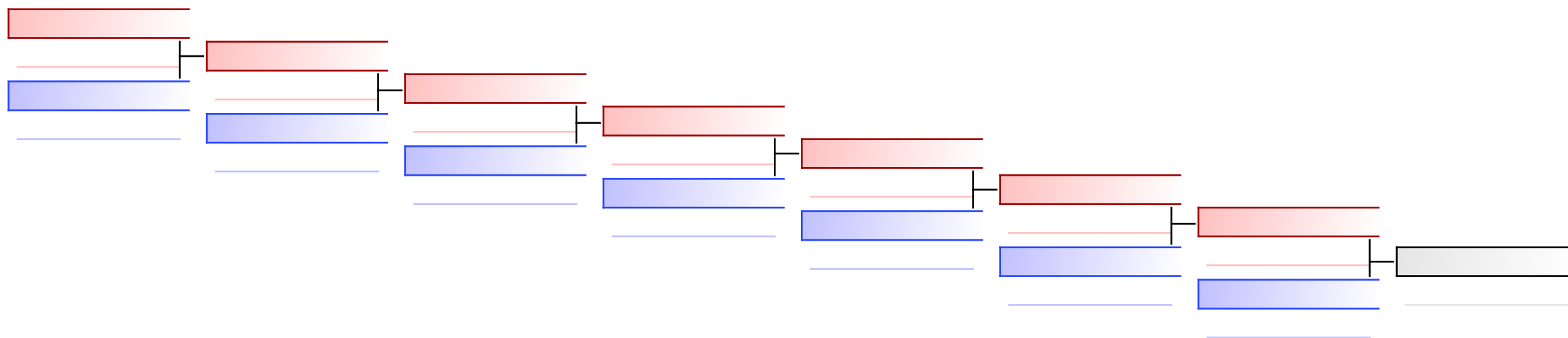

Referees:							
-----------	--	--	--	--	--	--	--

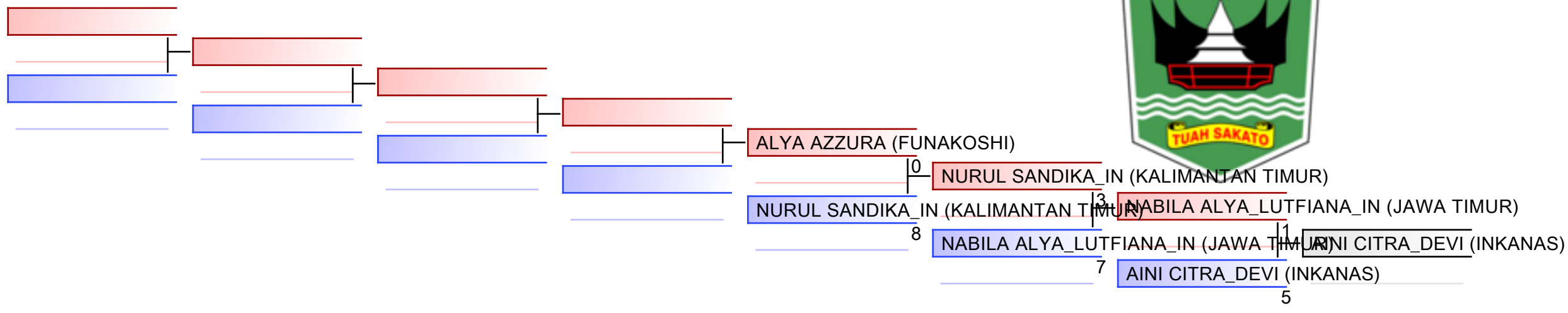

REPECHAGE: (1)

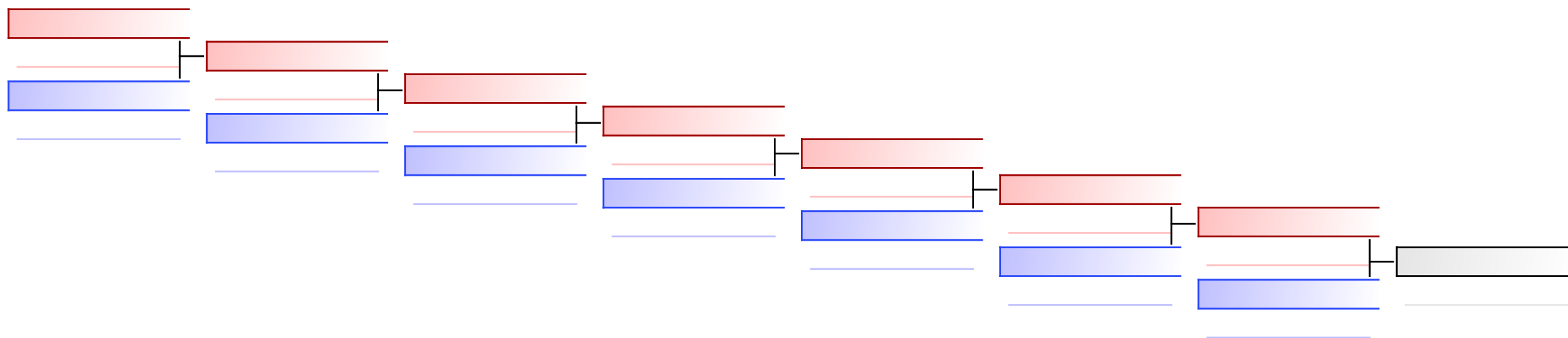

Referees:							
-----------	--	--	--	--	--	--	--

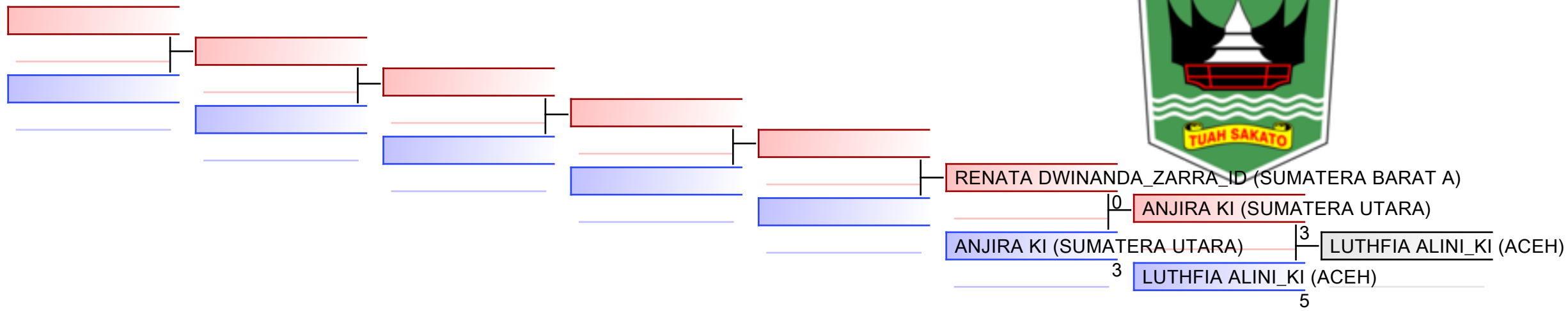

REPECHAGE: (2)

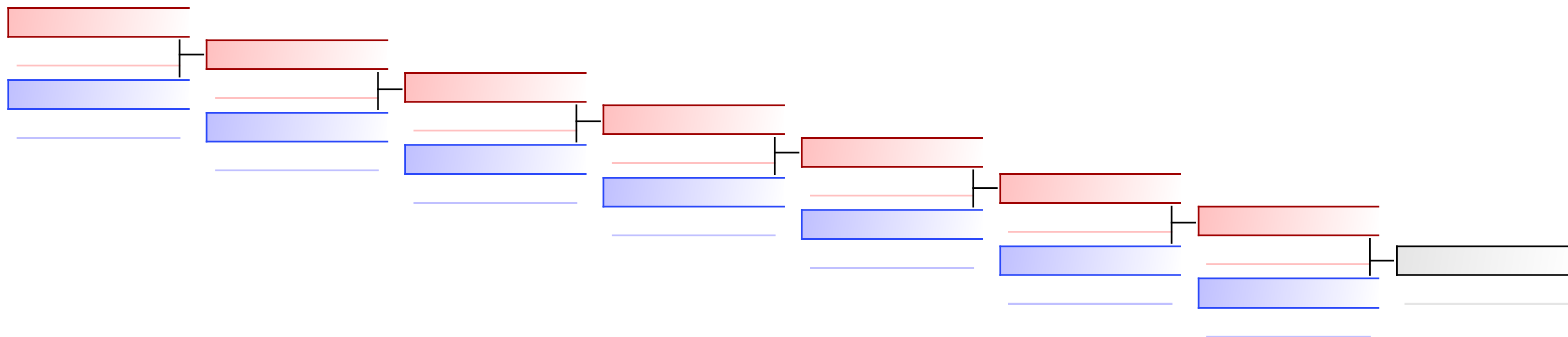

Referees:							
-----------	--	--	--	--	--	--	--