



























**KEJUARAAN NASIONAL KARATE PIALA KETUA  
UMUM PB FORKI TAHUN 2022 - 2022-10-03**





**Medals - Club**





Rank	Club	1. Place	2. Place	3. Place
1	 DKI JAKARTA, INA	6	3	3
2	 INKAI, INA	2	4	4
3	 JAWA BARAT, INA	2	4	3
4	 ASKI, INA	2	2	1
5	 KKI, INA	2	1	2
6	 BALI, INA	2	1	1
7	 LEMKARI, INA	2	0	1
8	 INKANAS, INA	1	1	5
9	 SUMATERA UTARA, INA	1	0	2
	 WADOKAI, INA	1	0	2
	 SULAWESI UTARA, INA	1	0	2
12	 INKADO, INA	1	0	1
13	 JAWA TIMUR, INA	0	2	4
14	 LAMPUNG, INA	0	1	2
15	 GOJUKAI, INA	0	1	1
16	 KEI SHIN KAN, INA	0	1	0
	 MALUKU, INA	0	1	0
	 SHOTO-KAI, INA	0	1	0
19	 JAWA TENGAH, INA	0	0	3
20	 ACEH, INA	0	0	2
	 SUMATERA BARAT A, INA	0	0	2
22	 KALIMANTAN TIMUR, INA	0	0	1
	 BANTEN, INA	0	0	1
	 BUDOKAI, INA	0	0	1
	 SULAWESI SELATAN, INA	0	0	1
	 BKC, INA	0	0	1

**KEJUARAAN NASIONAL KARATE PIALA KETUA  
UMUM PB FORKI TAHUN 2022 - 2022-10-03**

**Official Results**

<b>JUNIOR KATA BEREGU PUTRA</b>				
1	DKI JAKARTA - ADZI AHMAD_DZIKRILLAH_NUR_HIDAYAH_GD - GERRARD ERLANGGA_W_P_IS - MUHAMMAD PASYA_ARDIANSYAH_IN	DKI JAKARTA		INA - INDONESIA
2	INKANAS - AGUS RIAN_KURNIA - MAULANA MALIK_AWALUDIN - RIFKI FADHLI_NAUFAL_HERMAWAN	INKANAS		INA - INDONESIA
3	JAWA TIMUR - ACHMAD DZAKY_IN - IRFAN MAHMUD_PRATAMA_IN	JAWA TIMUR		INA - INDONESIA
3	INKAI - ABYAN AL_FADHI - NICKY HARDIANA_CAESAR - RAHMATULLAH BAGAS_PUTRA	INKAI		INA - INDONESIA

<b>JUNIOR KATA BEREGU PUTRI</b>				
1	DKI JAKARTA - BEATRIX HELENA_PANGEMANAN_GK - NADLIMA LAYLA_IN - SYIFA AMALIA_AHMAD_IS	DKI JAKARTA		INA - INDONESIA
2	INKAI - AJRIYA NAJWAH_NURUL_AINI - DERILLA THAMA_FITRI - NABILA PUTRI_RAMADHANI	INKAI		INA - INDONESIA
3	SULAWESI UTARA - CHRISTANIA MARIA_RONDO_ID - SHELOMITHA LIE_HOSANG_ID - VANESA CINTA_IMANUELLA_MUAYA_GK	SULAWESI UTARA		INA - INDONESIA
3	SUMATERA BARAT A - FADILLA YOLANDA_OKTARI_IN - PUTI RAYSHA_DAZERA_ID - SYIFA AQILAH_WENADRA_IS	SUMATERA BARAT A		INA - INDONESIA



<b>JUNIOR KATA PERORANGAN PUTRA</b>				
1	HAZEL RAMADHAN IN	JAWA BARAT		INA - INDONESIA
2	MUHAMMAD AKIO ZAIKO IS	DKI JAKARTA		INA - INDONESIA
3	CHRISTOPHER EDBERT SETIABUDI SI	JAWA TENGAH		INA - INDONESIA
3	MUH ABY MEZAR GK	SULAWESI SELATAN		INA - INDONESIA

<b>JUNIOR KATA PERORANGAN PUTRI</b>				
1	BEATRIX HELENA PANGEMANAN GK	DKI JAKARTA		INA - INDONESIA
2	NABILA PUTRI RAMADHANI	INKAI		INA - INDONESIA
3	ANANDITHA MUTIA ZAHARA S	GOJUKAI		INA - INDONESIA
3	ANDINI ALIFIAH NURCAHYA	BUDOKAI		INA - INDONESIA

<b>JUNIOR KUMITE PUTRA +76 KG</b>				
1	GEDE ARYA PUJA ADNYANA	KKI		INA - INDONESIA

**KEJUARAAN NASIONAL KARATE PIALA KETUA  
UMUM PB FORKI TAHUN 2022 - 2022-10-03**

**Official Results**

2	SIN AHMAD QODDRIH KI	LAMPUNG		INA - INDONESIA	
3	RADAR STEAGEAL SEJATI IS	JAWA BARAT		INA - INDONESIA	
3	MADE ANDIKA PRAMANA PUTRA KI	BALI		INA - INDONESIA	

**JUNIOR KUMITE PUTRA -55 KG**

1	JOSEPH MARIANNO RATHZINGER IN	DKI JAKARTA		INA - INDONESIA	
2	DAFFA FAALIH ANANTA	ASKI		INA - INDONESIA	
3	YOHANES MUHAMAD RAMDAN KI	JAWA BARAT		INA - INDONESIA	
3	MUHAMMAD IMAM KI	ACEH		INA - INDONESIA	

**JUNIOR KUMITE PUTRA -61 KG**

1	KOMANG SASTRAWAN LK	BALI		INA - INDONESIA	
2	LINGGA KURNIAWAN	ASKI		INA - INDONESIA	
3	L MUHAMMAD AZWIN	INKAI		INA - INDONESIA	
3	AHMAD ALAYDRUS IN	JAWA TIMUR		INA - INDONESIA	

**JUNIOR KUMITE PUTRA -68 KG**

1	AKBAR TYO PAMUNGKAS	ASKI		INA - INDONESIA	
2	BAMBANG PRIYAMBODO	INKAI		INA - INDONESIA	
3	FIRMAN GENTURIN	JAWA TIMUR		INA - INDONESIA	
3	DAIVA MAHADANA IS	DKI JAKARTA		INA - INDONESIA	

**JUNIOR KUMITE PUTRA -76 KG**

1	NATHANIEL ABIMANYU	ASKI		INA - INDONESIA	
2	FX ALVONSSE WIDYANSYAH	SHOTO-KAI		INA - INDONESIA	
3	MUHAMMAD YUSUF SYAHADAN	INKADO		INA - INDONESIA	
3	BRILLYAN DIMAS BAGASKARA	INKAI		INA - INDONESIA	

**JUNIOR KUMITE PUTRI +59 KG**

1	ALMAHYRA TIARA SANDI	INKANAS		INA - INDONESIA	
2	SITI NUR AUFA BAHA	KKI		INA - INDONESIA	
3	SAUSAN AULIA SESI IN	BANTEN		INA - INDONESIA	
3	MEIVIONA ZUHRINA WK	SUMATERA UTARA		INA - INDONESIA	

**JUNIOR KUMITE PUTRI -48 KG**





1	REYGISTA DWI AMANDA KI	DKI JAKARTA		INA - INDONESIA	
2	MULIA JISCHA CHERRYL S IS	JAWA TIMUR		INA - INDONESIA	
3	ALYA DEANTI SUTENDI IN	JAWA BARAT		INA - INDONESIA	
3	SYERIEL DEBORA WENNO	INKANAS		INA - INDONESIA	





**JUNIOR KUMITE PUTRI -53 KG**

1	NAJLA SYAKIRA	WADOKAI		INA - INDONESIA	
2	LOVIA GINDHA PUSPITA IS	DKI JAKARTA		INA - INDONESIA	
3	LUVENA MILANO SETIYAKA IN	JAWA TENGAH		INA - INDONESIA	
3	SYEERIN RAMADANI S IS	KALIMANTAN TIMUR		INA - INDONESIA	





**KEJUARAAN NASIONAL KARATE PIALA KETUA  
UMUM PB FORKI TAHUN 2022 - 2022-10-03**

**Official Results**





<b>JUNIOR KUMITE PUTRI -59 KG</b>					
1	ADELIA INDAH PERMATA SARI TUASIKAL	INKADO		INA - INDONESIA	
2	NI MADE DWI KARTIKA APRIANTI IN	BALI		INA - INDONESIA	
3	NAJWA SABILA HABIBIE	INKANAS		INA - INDONESIA	
3	LISYE KASIH SATIAMU AS	SULAWESI UTARA		INA - INDONESIA	

<b>KADET KATA PERORANGAN PUTRA</b>					
1	NAUFAL PUTRA DIANDRA	INKAI		INA - INDONESIA	
2	MUHAMMAD PASYA ARDIANSYAH IN	DKI JAKARTA		INA - INDONESIA	
3	VICTOR BELVA ANANTA NURRACHMAN IN	JAWA TIMUR		INA - INDONESIA	
3	HARAY SHOKE LAMINDO GA	LAMPUNG		INA - INDONESIA	

<b>KADET KATA PERORANGAN PUTRI</b>					
1	RENATA GLORY MADA O ID	JAWA BARAT		INA - INDONESIA	
2	SALSABILA RIHHADATUL`AISY AMRULLAH	KEI SHIN KAN		INA - INDONESIA	
3	KANAYA SCARLETTA POLII	INKANAS		INA - INDONESIA	
3	NADLIMA LAYLA IN	DKI JAKARTA		INA - INDONESIA	

<b>KADET KUMITE PUTRA +70 KG</b>					
1	MUHAMMAD PADI FAUZAN SYAM	KKI		INA - INDONESIA	
2	RACKEE BALARAMA	INKAI		INA - INDONESIA	
3	AQDAS MIFTAHUL KASFILLAH	INKANAS		INA - INDONESIA	
3	NAUFAL DZAKY ANSYORI IS	SUMATERA BARAT A		INA - INDONESIA	





<b>KADET KUMITE PUTRA -52 KG</b>					
1	M DHIJEY LEXSIE SI	SUMATERA UTARA		INA - INDONESIA	
2	ARJEN PAAIS LK	MALUKU		INA - INDONESIA	
3	MADE RYAN ADITYA JAYA	KKI		INA - INDONESIA	
3	TIO TRIRALY SAMBENTIRO	WADOKAI		INA - INDONESIA	

<b>KADET KUMITE PUTRA -57 KG</b>					
1	I KADEK ANGGA PRADITA LK	BALI		INA - INDONESIA	
2	YANUR SYAFA`AT SABILILLAH IN	JAWA TIMUR		INA - INDONESIA	
3	FAHREL APRIANSYAH AMARTHA KI	LAMPUNG		INA - INDONESIA	
3	AURIGA ARYASATYA MULYANTO AS	JAWA TENGAH		INA - INDONESIA	





<b>KADET KUMITE PUTRA -63 KG</b>					
1	DINO BAGUS ARYO SETO	LEMKARI		INA - INDONESIA	
2	MOCHAMMAD FEBRILYANSYAH LK	JAWA BARAT		INA - INDONESIA	
3	FAREL ARAFI HILMANSYAH LK	SUMATERA UTARA		INA - INDONESIA	
3	MUHAMMAD LEO PUTRA IN	DKI JAKARTA		INA - INDONESIA	

**KEJUARAAN NASIONAL KARATE PIALA KETUA  
UMUM PB FORKI TAHUN 2022 - 2022-10-03**

**Official Results**

<b>KADET KUMITE PUTRA -70 KG</b>				
1	ALFIAN SURYA	INKAI		INA - INDONESIA
2	BILLY PASYAH PURNOMO BC	JAWA BARAT		INA - INDONESIA
3	RAIHANI IRFANDA	LEMKARI		INA - INDONESIA
3	YOHANES RADO SUMANIK	BKC		INA - INDONESIA

<b>KADET KUMITE PUTRI +54 KG</b>				
1	NAFAHATIN FADILLAH ARAFAT	LEMKARI		INA - INDONESIA
2	GHINA MUFIDA	GOJUKAI		INA - INDONESIA
3	RAHMATIKA DWI WAHYUNINGRUM	INKAI		INA - INDONESIA
3	FAKHRIYYAH HAMID	KKI		INA - INDONESIA

<b>KADET KUMITE PUTRI -47 KG</b>				
1	FAYYAZA LAIQHA ZAHLULA IN	DKI JAKARTA		INA - INDONESIA
2	KIRANA ANISA-BC	JAWA BARAT		INA - INDONESIA
3	SALWA ALYA ERSATAMA	ASKI		INA - INDONESIA
3	SYIFA SALSABILA	WADOKAI		INA - INDONESIA

<b>KADET KUMITE PUTRI -54 KG</b>				
1	ERINE BRYTHANIA AURORA POTOROLI IN	SULAWESI UTARA		INA - INDONESIA
2	NADHYA IS	JAWA BARAT		INA - INDONESIA
3	AINI CITRA DEVI	INKANAS		INA - INDONESIA
3	LUTHFIA ALINI KI	ACEH		INA - INDONESIA

**KEJUARAAN NASIONAL KARATE PIALA KETUA  
UMUM PB FORKI TAHUN 2022 - 2022-10-03  
JUNIOR KATA BEREGU PUTRA**

**R1 G1/2 (7) Tatami 2 12:25(2022-10-04)**

Competitors	Kata	1T	1A	2T	2A	3T	3A	4T	4A	5T	5A	6T	6A	7T	7A	TEC	ATH	Extra	Total Rank
1 SULAWESI UTARA (ARYADINATA, CHRISTIVO, IRFAN) (SULAWESI UTARA)		(7.2)	(7.0)	(7.0)	7.0	7.2	(7.2)	7.2	7.2	7.2	7.0	(7.4)	(7.4)	(7.0)	(6.8)	15.12	6.36		21.485
2 SHOKAIDO (KAKA, SATRYO, VITTO) (SHOKAIDO)	GOJUSHIHO	(7.0)	(6.8)	(7.2)	(7.2)	(7.4)	7.2	7.2	(7.4)	7.0	(7.0)	7.2	7.2	(6.8)	7.2	14.98	6.48		21.466
3 JAWA TIMUR (ACHMAD, IRFAN) (JAWA TIMUR)	KANKU SHO	(7.4)	(7.2)	7.4	7.2	(7.6)	(7.4)	7.4	7.4	(7.2)	7.2	7.4	(7.6)	(7.2)	(7.0)	15.54	6.54		22.082
4 BUDOKAI (M, RAIHAN, SATRIA) (BUDOKAI)	SUPARINPEI	7.2	7.0	(7.0)	(6.8)	(7.4)	(7.2)	7.2	(6.8)	7.2	7.0	(7.4)	(7.2)	(6.8)	6.8	15.12	6.24		21.367
5 INKANAS (AGUS, MAULANA, RIFKI) (INKANAS)	CHIBANA NO KUSHANKU	(7.6)	(7.4)	(7.2)	7.2	(7.6)	(7.4)	7.4	7.2	(7.2)	(7.0)	7.6	7.4	7.2	(7.0)	15.54	6.54		22.083
6 ACEH (M, MUHAMMAS, ROFFI) (ACEH)	SUPARINPEI	7.2	(7.0)	(7.0)	(7.2)	(7.4)	7.2	(7.0)	(7.0)	(7.4)	7.2	7.2	7.0	7.2	(7.4)	15.12	6.42		21.544
7 INKAI (ABYAN, NICKY, RAHMATULLAH) (INKAI) (*2)	GOJUSHIHO	(7.0)	(6.8)	(7.6)	(7.6)	(7.6)	(7.6)	7.4	(7.4)	(7.2)	7.4	7.4	7.6	7.2	7.6	15.4	6.78		22.181

**R1 G2/2 (6) Tatami 1 12:35(2022-10-04)**

Competitors	Kata	1T	1A	2T	2A	3T	3A	4T	4A	5T	5A	6T	6A	7T	7A	TEC	ATH	Extra	Total Rank
1 JAMBI (ABEL, AHMAD, R) (JAMBI)	KANKU SHO	7.2	7.2	(7.4)	(7.6)	(7.4)	(7.4)	(7.0)	(7.0)	7.2	(7.0)	7.2	7.0	(7.0)	7.0	15.12	6.36		21.485
2 GOJUKAI (FATHAM, MUHAMMAD) (GOJUKAI)	SEISAN	(7.4)	7.2	(7.4)	(7.6)	(6.8)	(7.0)	7.2	(7.4)	7.4	(7.0)	7.0	7.4	7.2	7.4	15.26	6.6		21.863
3 INKADO (MUHAMMAD, SENO, YEHEZKIEL) (INKADO)	UNSU	(7.2)	(7.4)	7.2	(7.4)	(7.0)	(7.2)	(7.4)	(7.2)	(7.4)	7.4	7.4	7.4	7.4	7.2	15.4	6.6		22.0 2
4 LEMKARI (DEGA, FARIZ, NUGRAHA) (LEMKARI)	UNSU	7.0	(6.8)	(7.2)	(7.4)	(7.2)	(7.4)	(6.8)	(6.8)	7.2	7.2	(6.8)	7.4	6.8	7.0	14.7	6.48		21.186
5 SUMATERA BARAT A (GEMA, MUHAMMAD, NABIL) (SUMATERA BARAT A)	KANKU SHO	(7.4)	(7.6)	(7.2)	7.4	(7.4)	(7.6)	(7.2)	7.2	7.4	(6.8)	7.2	7.2	7.2	(7.0)	15.26	6.54		21.8 4
6 DKI JAKARTA (ADZI, GERRARD, MUHAMMAD) (DKI JAKARTA) (*1)	PAPUREN	(7.8)	(7.6)	(7.6)	(7.6)	7.6	(7.4)	7.6	7.4	(7.4)	7.6	7.6	7.6	(7.4)	(7.2)	15.96	6.78		22.741

**R2-G1 Tatami 2 13:10(2022-10-04)**

Competitors	Kata	1T	1A	2T	2A	3T	3A	4T	4A	5T	5A	6T	6A	7T	7A	TEC	ATH	Extra	Total Rank
1 ACEH (M, MUHAMMAS, ROFFI) (ACEH)	ANAN DAI	(6.8)	7.0	6.8	(6.6)	(7.2)	6.8	7.2	(7.2)	(7.4)	(7.2)	6.8	(6.6)	(6.2)	6.6	14.56	6.12		20.684
2 INKAI (ABYAN, NICKY, RAHMATULLAH) (INKAI)	KANKU SHO	(6.8)	(6.6)	7.0	(7.2)	(7.4)	(7.0)	7.2	(7.4)	7.2	7.0	7.0	7.0	(6.8)	7.0	14.84	6.3		21.143
3 INKANAS (AGUS, MAULANA, RIFKI) (INKANAS)	SANSAI	(7.4)	(7.2)	(7.2)	(7.0)	7.4	7.2	(7.6)	(7.6)	7.2	7.2	7.2	7.2	(6.6)	(6.4)	15.26	6.48		21.741
4 JAWA TIMUR (ACHMAD, IRFAN) (JAWA TIMUR)	GANKAKU	7.2	7.0	7.2	(6.8)	(7.6)	(7.2)	(7.8)	(7.8)	7.4	7.2	(7.0)	7.0	(6.0)	(6.2)	15.26	6.36		21.622

**R2-G2 Tatami 1 13:10(2022-10-04)**

Competitors	Kata	1T	1A	2T	2A	3T	3A	4T	4A	5T	5A	6T	6A	7T	7A	TEC	ATH	Extra	Total Rank
1 DKI JAKARTA (ADZI, GERRARD, MUHAMMAD) (DKI JAKARTA)		(7.8)	(7.8)	(7.8)	7.6	(7.4)	(7.2)	7.8	(7.8)	(7.2)	(7.4)	7.6	7.8	7.4	7.4	15.96	6.84		22.8 1
2 INKADO (MUHAMMAD, SENO, YEHEZKIEL) (INKADO)	GOJUSHIHO SHO	(7.4)	7.4	7.4	7.4	(7.2)	(7.0)	(7.6)	(7.8)	7.4	7.4	(7.6)	(7.6)	7.4	(7.2)	15.54	6.66		22.2 3
3 GOJUKAI (FATHAM, MUHAMMAD) (GOJUKAI)	SUPARINPEI	(7.6)	(7.4)	(7.6)	7.4	7.4	7.4	7.6	(7.8)	(7.2)	(7.0)	7.6	7.4	(7.2)	(7.2)	15.82	6.66		22.482
4 SUMATERA BARAT A (GEMA, MUHAMMAD, NABIL) (SUMATERA BARAT A)	GANKAKU	(7.2)	(7.0)	(7.4)	(7.0)	(7.2)	7.2	7.2	7.2	(7.6)	(7.4)	7.4	(7.6)	7.4	7.2	15.4	6.48		21.884

**R3 Bronze Medal Match 1 Tatami 2 13:35(2022-10-04)**

Competitors	Kata	1T	1A	2T	2A	3T	3A	4T	4A	5T	5A	6T	6A	7T	7A	TEC	ATH	Extra	Total Rank
1 INKADO (MUHAMMAD, SENO, YEHEZKIEL) (INKADO)	ANAN	(7.2)	(7.2)	(7.2)	(7.0)	7.2	7.2	7.2	(7.4)	(7.4)	7.2	(7.4)	7.4	7.4	(7.6)	15.26	6.54		21.8 2
2 JAWA TIMUR (ACHMAD, IRFAN) (JAWA TIMUR)	UNSU	(7.4)	(7.2)	(7.4)	(7.4)	7.4	(7.2)	7.4	7.4	7.4	7.2	(7.6)	(7.6)	(7.8)	7.4	15.54	6.6		22.141

**R3 Bronze Medal Match 2 Tatami 1 13:35(2022-10-04)**

Competitors	Kata	1T	1A	2T	2A	3T	3A	4T	4A	5T	5A	6T	6A	7T	7A	TEC	ATH	Extra	Total Rank
1 GOJUKAI (FATHAM, MUHAMMAD) (GOJUKAI)	KURURUNFA	(7.4)	(7.4)	(7.0)	(7.2)	(7.8)	(7.6)	(7.6)	7.4	7.4	7.4	7.4	7.4	7.6	(7.6)	15.68	6.66		22.342
2 INKAI (ABYAN, NICKY, RAHMATULLAH) (INKAI)	UNSU	(7.6)	(7.6)	(7.2)	(7.4)	(7.8)	(7.8)	(7.8)	7.6	7.6	7.6	7.6	7.6	7.8	(7.8)	16.1	6.84		22.941

**R3 Gold Medal Match Tatami 1 13:50(2022-10-04)**

Competitors	Kata	1T	1A	2T	2A	3T	3A	4T	4A	5T	5A	6T	6A	7T	7A	TEC	ATH	Extra	Total Rank
1 DKI JAKARTA (ADZI, GERRARD, MUHAMMAD) (DKI JAKARTA)	ANAN	7.6	7.6	(7.4)	(7.2)	(7.8)	7.6	7.6	7.6	(7.4)	(7.4)	7.6	(7.8)	(7.8)	(7.8)	15.96	6.84		22.8 1
2 INKANAS (AGUS, MAULANA, RIFKI) (INKANAS)	UNSU	(7.2)	(7.4)	7.6	7.4	7.6	7.4	(7.8)	(7.8)	(7.2)	(7.2)	7.6	(7.6)	(7.8)	7.6	15.96	6.72		22.682

**KEJUARAAN NASIONAL KARATE PIALA KETUA  
UMUM PB FORKI TAHUN 2022 - 2022-10-03  
JUNIOR KATA BEREGU PUTRA**

**Results**

1	DKI JAKARTA - ADZI AHMAD_DZIKRILLAH_NUR_HIDAYAH_GD - GERRARD ERLANGGA_W_P_IS - MUHAMMAD PASYA_Ardiansyah_IN	DKI JAKARTA		INDONESIA
2	INKANAS - AGUS RIAN_KURNIA - MAULANA MALIK_AWALUDIN - RIFKI FADHLI_NAUHAL_HERMAWAN	INKANAS		INDONESIA
3	JAWA TIMUR - ACHMAD DZAKY_IN - IRFAN MAHMUD_PRATAMA_IN	JAWA TIMUR		INDONESIA
3	INKAI - ABYAN AL_FADHI - NICKY HARDIANA_CAESAR - RAHMATULLAH BAGAS_PUTRA	INKAI		INDONESIA
5	INKADO - MUHAMMAD YUSUF_SYHADAN - SENO AJIDARMA_PUTRA - YEHEZKIEL TAMPANATU_ROTTO	INKADO		INDONESIA
5	GOJUKAI - FATHAM INSYIROH_RIZKI_PILUNG - MUHAMMAD KAHFI_N_R	GOJUKAI		INDONESIA
7	ACEH - M MULIADIANSYAH_PUTRA_GD - MUHAMMAD ARIZ_ALANA_ILHAM_GD - ROFFI MURTADO_GD	ACEH		INDONESIA
7	SUMATERA BARAT A - GEMA AWAL_RAMADHAN_IS - MUHAMMAD KEVIN_ALFAREZI_LK - NABIL AZZURA_ASSIRIN_LK	SUMATERA BARAT A		INDONESIA

**KEJUARAAN NASIONAL KARATE PIALA KETUA  
UMUM PB FORKI TAHUN 2022 - 2022-10-03  
JUNIOR KATA BEREGU PUTRI**

**R1 G1/2 (3) Tatami 4 12:00(2022-10-04)**

Competitors	Kata	1 T	1 A	2 T	2 A	3 T	3 A	4 T	4 A	5 T	5 A	6 T	6 A	7 T	7 A	TEC	ATH	Extra	Total	Rank
1 SUMATERA BARAT A (FADILLA, PUTI, SYIFA) (SUMATERA BARAT A)	KANKU SHO	(6.6)	(7.0)	(7.2)	(7.2)	7.2	7.2	7.2	7.2	(7.6)	(7.4)	(6.8)	(7.0)	7.0	7.0	14.98	6.42		21.4	3
2 SULAWESI UTARA (CHRISTANIA, SHELOMITHA, VANESA) (SULAWESI UTARA)	PAPUREN	(7.0)	(7.2)	(7.4)	(7.2)	(7.0)	7.2	(7.4)	(7.4)	7.4	(7.4)	7.4	7.4	7.4	7.2	15.54	6.54		22.08	2
3 DKI JAKARTA (BEATRIX, NADLIMA, SYIFA) (DKI JAKARTA) (*2)		(7.4)	(7.4)	(7.4)	(7.4)	(7.6)	(7.6)	7.6	7.6	(7.8)	7.6	7.6	(7.8)	7.6	7.4	15.96	6.78		22.74	1

**R1 G2/2 (3) Tatami 3 12:10(2022-10-04)**

Competitors	Kata	1 T	1 A	2 T	2 A	3 T	3 A	4 T	4 A	5 T	5 A	6 T	6 A	7 T	7 A	TEC	ATH	Extra	Total	Rank
1 JAWA TIMUR (NOVITA, SHAFI, TANTRI) (JAWA TIMUR)	UNSU	(7.0)	(7.0)	(7.6)	(7.2)	(7.4)	(7.2)	7.0	7.2	7.0	7.2	(7.0)	(6.8)	(7.0)	7.2	14.84	6.48		21.32	3
2 INKADO (ANGGI, REVA, STEVANIA) (INKADO)	KANKU	(7.4)	(7.4)	(7.6)	(7.6)	(7.2)	(7.0)	(7.2)	7.2	(7.0)	7.2	7.2	7.2	7.0	7.0	15.12	6.42		21.54	2
3 INKAI (AJRIYA, DERILLA, NABILA) (INKAI) (*1)	GOJUSHIHO DAI	(7.8)	(7.8)	(7.8)	(7.8)	7.6	(7.4)	(7.4)	7.4	(7.4)	7.4	7.4	(7.0)	7.6	7.4	15.82	6.66		22.48	1

**R2 Bronze Medal Match 1 Tatami 4 12:30(2022-10-04)**

Competitors	Kata	1 T	1 A	2 T	2 A	3 T	3 A	4 T	4 A	5 T	5 A	6 T	6 A	7 T	7 A	TEC	ATH	Extra	Total	Rank
1 SULAWESI UTARA (CHRISTANIA, SHELOMITHA, VANESA) (SULAWESI UTARA)	ANAN	(7.2)	(6.8)	(7.4)	7.2	(7.4)	7.2	7.4	7.2	(7.2)	(7.0)	7.4	(7.4)	7.4	(7.6)	15.54	6.48		22.02	1
2 JAWA TIMUR (NOVITA, SHAFI, TANTRI) (JAWA TIMUR)		(7.0)	(6.2)	(6.8)	6.8	7.0	(6.6)	(7.2)	(7.0)	7.0	6.8	7.0	(7.2)	(7.2)	6.8	14.7	6.12		20.82	2

**R2 Bronze Medal Match 2 Tatami 3 12:30(2022-10-04)**

Competitors	Kata	1 T	1 A	2 T	2 A	3 T	3 A	4 T	4 A	5 T	5 A	6 T	6 A	7 T	7 A	TEC	ATH	Extra	Total	Rank
1 SUMATERA BARAT A (FADILLA, PUTI, SYIFA) (SUMATERA BARAT A)	UNSU	(7.0)	(7.2)	(7.4)	(7.0)	(7.2)	7.0	(7.4)	7.2	7.4	7.2	(6.8)	7.4	(7.4)	7.4	15.4	6.42		21.82	1
2 INKADO (ANGGI, REVA, STEVANIA) (INKADO)	ANAN	(6.8)	(7.0)	(7.4)	(7.4)	(6.8)	(6.6)	7.2	7.0	7.2	7.0	(7.4)	(7.2)	7.0	7.0	14.98	6.3		21.28	2

**R2 Gold Medal Match Tatami 3 12:45(2022-10-04)**

Competitors	Kata	1 T	1 A	2 T	2 A	3 T	3 A	4 T	4 A	5 T	5 A	6 T	6 A	7 T	7 A	TEC	ATH	Extra	Total	Rank
1 DKI JAKARTA (BEATRIX, NADLIMA, SYIFA) (DKI JAKARTA)	ANAN	(7.6)	(7.4)	7.6	(7.4)	(7.8)	(7.6)	(7.8)	(7.6)	7.8	7.6	7.6	7.4	(7.4)	7.4	16.1	6.72		22.82	1
2 INKAI (AJRIYA, DERILLA, NABILA) (INKAI)	UNSU	(7.2)	(7.2)	(7.4)	(7.2)	(7.4)	(6.8)	7.4	(7.2)	7.4	7.2	7.2	(7.0)	7.2	7.2	15.4	6.48		21.88	2

**Results**

1	DKI JAKARTA - BEATRIX HELENA_PANGEMANAN_GK - NADLIMA LAYLA_IN - SYIFA AMALIA_AHMAD_IS	DKI JAKARTA		INDONESIA
2	INKAI - AJRIYA NAJWAH_NURUL_AINI - DERILLA THAMA_FITRI - NABILA PUTRI_RAMADHANI	INKAI		INDONESIA
3	SULAWESI UTARA - CHRISTANIA MARIA_RONDO_ID - SHELOMITHA LIE_HOSANG_ID - VANESA CINTA_IMANUELLA_MUAYA_GK	SULAWESI UTARA		INDONESIA
3	SUMATERA BARAT A - FADILLA YOLANDA_OKTARI_IN - PUTI RAYSHA_DAZERA_ID - SYIFA AQILAH_WENADRA_IS	SUMATERA BARAT A		INDONESIA
5	JAWA TIMUR - NOVITA PUTRI_KAILA_IN - SHAFI NUR_NAILA_MUNA_IN - TANTRI EKA_MULYANI_IN	JAWA TIMUR		INDONESIA
5	INKADO - ANGGI PUTRI_SINTYA_SABILA - REVA - DEFINA_JESISKA_PRASWOYO_LANDAU - STEVANIA PRISKILA_MANDAPANG	INKADO		INDONESIA



**KEJUARAAN NASIONAL KARATE PIALA KETUA  
UMUM PB FORKI TAHUN 2022 - 2022-10-03  
JUNIOR KATA PERORANGAN PUTRA**

**R1 G1/4 (8) Tatami 1 09:00(2022-10-04)**

Competitors	Kata	1T	1A	2T	2A	3T	3A	4T	4A	5T	5A	6T	6A	7T	7A	TEC	ATH	Extra	Total Rank
1 ARYA MUDDATSIR_SR (SULAWESI BARAT)	UNSU	(7.4)	(7.0)	(7.0)	(6.8)	(7.2)	(7.2)	(7.2)	7.0	7.2	7.0	7.2	7.2	7.2	(7.6)	15.126	6.36		21.486
2 LAURENTIUS ARYA_PANDHITA_WICAKSANA_GK (DIY)	KURURUNFA	(6.8)	(7.0)	7.2	(7.2)	(7.4)	(7.2)	(6.8)	7.2	7.2	7.2	7.4	7.2	(7.8)	(7.8)	15.266	6.48		21.745
3 MUHAMMAD KAHFI_N_R (GOJUKAI)	KURURUNFA	(7.4)	(7.4)	(7.4)	(7.4)	(7.4)	7.4	(7.0)	(7.0)	7.4	7.4	7.4	7.4	(7.2)	(7.2)	15.546	6.66	22.2	2
4 M MULIADIANSYAH_PUTRA_GD (ACEH)	ANAN DAI	7.2	7.0	7.0	7.0	7.0	7.0	(6.6)	(6.8)	(6.8)	(6.8)	(7.6)	(7.4)	(7.4)	(7.2)	14.846	6.3		21.147
5 FITO SAPUTRA (GOKASI)	ANAN DAI	6.8	6.8	6.8	(6.6)	6.8	6.8	(6.4)	(6.4)	(6.6)	6.6	(7.0)	(7.2)	(7.2)	(7.2)	14.286	6.06		20.348
6 ALVITO ABHISTA (BUDOKAI)		(7.4)	(7.6)	(7.2)	(7.4)	(7.2)	(7.0)	(7.4)	7.4	7.4	(7.6)	7.2	7.4	7.4	7.6	15.4	6.72		22.124
7 YEHEZKIEL TAMPANATU_ROTTOY (INKADO)	UNSU	7.4	(7.2)	(7.2)	(7.2)	7.4	7.2	(7.6)	7.4	(7.2)	(7.6)	7.4	(7.6)	(7.6)	7.6	15.546	6.66	22.2	3
8 MUHAMMAD AKIO_ZAIKO_IS (DKI JAKARTA) (*4)	OYADOMARI NO PASSAI	7.6	(7.4)	(7.4)	(7.6)	7.6	7.4	(7.8)	(7.6)	(7.4)	(7.2)	(7.8)	7.6	7.6	7.6	15.966	7.78		22.741

**R1 G2/4 (7) Tatami 1 10:00(2022-10-04)**

Competitors	Kata	1T	1A	2T	2A	3T	3A	4T	4A	5T	5A	6T	6A	7T	7A	TEC	ATH	Extra	Total Rank
1 ABYAN AL FADHI (INKAI)	GOJUSHIHO SHO	(7.4)	(7.6)	7.4	(7.6)	(7.0)	(6.8)	7.4	7.6	7.4	(7.2)	(7.6)	7.6	(7.6)	7.4	15.546	6.78		22.321
2 AYMAN RAHMAT_ALBADI (INKANAS)	UNSU	(7.4)	(7.2)	(7.2)	(7.4)	(7.2)	7.2	(7.4)	(7.4)	7.2	7.2	(7.0)	7.2	7.2	7.2	15.126	6.48		21.6
3 AHMAT RAHAGIL (ASKI)	UNSU	(7.0)	(6.8)	7.0	(7.2)	7.0	(7.0)	7.0	6.8	(6.8)	6.8	(7.2)	(6.6)	(6.6)	6.8	14.7	6.12		20.826
4 VERY ANDREAN_HANS_HARIANJA (SHIROITE)	SUPARINPEI	(6.8)	6.6	6.8	(6.8)	(6.6)	6.6	6.8	(6.8)	(6.6)	(6.4)	(7.2)	(6.2)	6.6	6.6	14.145	5.94		20.087
5 KOMANG SASTRAWAN_LK (BALI)	GANKAKU	(7.0)	(7.0)	(7.0)	7.4	(7.4)	7.2	(7.6)	(7.6)	7.2	7.4	7.2	(6.6)	7.4	(7.6)	15.266	6.6		21.862
6 KRISTIAN GARY_GAWAIDI_LK (KALIMANTAN BARAT)	KANKU SHO	(7.0)	6.8	7.0	(7.0)	(6.8)	(6.6)	7.0	7.0	7.0	7.0	(7.6)	(7.6)	(6.6)	(6.4)	14.7	6.24		20.945
7 NABIL AZZURA_ASSIRIN_LK (SUMATERA BARAT A) (*2)	GOJUSHIHO DAI	7.2	7.2	7.2	7.2	(6.6)	(6.8)	7.4	7.2	(7.6)	(7.4)	(7.6)	(7.6)	(6.8)	(7.0)	15.266	6.48		21.743

**R1 G3/4 (8) Tatami 2 09:00(2022-10-04)**

Competitors	Kata	1T	1A	2T	2A	3T	3A	4T	4A	5T	5A	6T	6A	7T	7A	TEC	ATH	Extra	Total Rank
1 YUDA MANOGI_PURBA_GD (SUMATERA UTARA)	ANAN DAI	(7.2)	(7.0)	(7.4)	(7.4)	7.2	(7.2)	(7.4)	7.2	7.4	7.2	(7.0)	7.2	7.4	(7.4)	15.4	6.48		21.886
2 DIKY ADITYA_REZKY_SYAHPUTRA_SI (KEPULAUAN RIAU)	KISHIMOTO NO KUSHANKU	(6.8)	(6.8)	(6.8)	7.0	(7.0)	(7.2)	6.8	(6.8)	(7.2)	(7.2)	6.8	7.0	7.0	7.0	14.426	6.3		20.728
3 AHMAD WAHIDIN_SAPUTRA_IN (JAMBI)	UNSU	(7.4)	(7.2)	(7.2)	(7.2)	7.4	(7.4)	7.4	(7.4)	(7.6)	7.2	(7.2)	7.2	7.4	7.4	15.4	6.54		21.944
4 MUH ABY_MEZAR_GK (SULAWESI SELATAN)	ANAN DAI	(7.6)	(7.6)	(7.4)	7.6	7.6	(7.4)	7.6	7.6	(8.4)	(8.4)	7.6	7.6	(7.4)	(7.2)	15.966	6.84	22.8	2
5 CHRISTIVO_GERALDEFANS_GARA_ID (SULAWESI UTARA)	UNSU	(7.0)	7.2	(7.2)	(7.0)	(7.4)	7.2	(7.0)	(6.6)	7.2	7.0	7.2	(7.4)	7.2	(7.4)	15.126	6.42		21.547
6 FAIQ FARHAN_HSB_IN (RIAU)	KANKU SHO	(7.4)	(7.4)	(7.0)	(7.0)	(7.4)	(7.4)	7.4	(7.0)	(7.0)	7.0	7.4	7.2	7.4	7.0	15.546	6.36		21.9
7 MOCHAMMAD_NALENDRA_BUANA_FN (JAWA TIMUR)	CHIBANA NO KUSHANKU	(7.4)	(7.4)	(7.6)	7.4	7.4	(7.2)	(7.6)	7.4	(7.2)	(7.0)	7.4	(7.6)	7.4	7.2	15.546	6.6		22.143
8 HAZEL RAMADHAN_IN (JAWA BARAT) (*3)	PAPUREN	(7.8)	(7.6)	(7.8)	(7.6)	7.8	(7.8)	(8.0)	(8.0)	(7.4)	7.8	7.8	7.8	7.8	7.6	16.386	6.96		23.341

**R1 G4/4 (7) Tatami 2 10:00(2022-10-04)**

Competitors	Kata	1T	1A	2T	2A	3T	3A	4T	4A	5T	5A	6T	6A	7T	7A	TEC	ATH	Extra	Total Rank
1 MUHAMMAD REIHAN_FADILLAH_IN (KALIMANTAN SELATAN)	ANAN DAI	(6.6)	(6.6)	(7.2)	(7.2)	(7.4)	(7.2)	7.0	6.8	7.0	6.6	(6.2)	(6.0)	7.2	7.0	14.846	6.12		20.963
2 NAFIS BUDI_RIANTO (SHOKAIDO)	UNSU	6.8	(6.6)	(7.0)	(7.2)	(7.4)	(7.4)	6.8	6.6	(6.6)	6.6	(6.4)	(6.2)	7.0	6.8	14.426	6.0		20.424
3 FARIZ AULIA_AZKA (LEMKARI)	GANKAKU	(6.4)	(6.4)	(7.2)	(7.4)	6.8	(6.8)	(7.0)	6.6	7.0	6.4	(5.8)	(6.0)	6.8	6.6	14.425	5.88		20.3
4 DISMA SANG_W_IN (KALIMANTAN TIMUR)	UNSU	(6.4)	(6.4)	(7.4)	(7.2)	(7.2)	(7.2)	6.8	(6.4)	(6.4)	6.4	6.4	6.4	6.8	6.8	14.0	5.88		19.887
5 MUH FADLY_IRWAN (KEI SHIN KAN)	CHIBANA NO KUSHANKU	(6.6)	(6.4)	(7.2)	(7.0)	(7.4)	(7.4)	6.8	6.8	(6.2)	(6.6)	6.6	6.6	6.8	7.0	14.146	6.12		20.266
6 CHRISTOPHER EDBERT_SETIABUDI_SI (JAWA TENGAH)		(7.6)	7.4	(7.4)	(7.6)	(7.6)	(7.6)	(7.4)	(7.2)	7.6	7.4	7.4	(7.2)	7.4	7.2	15.686	6.6	22.2	281
7 FADHLIKA MONAZI_GK (SUMATERA BARAT B) (*1)	SUPARINPEI	(6.6)	(6.6)	(7.0)	(7.2)	(7.6)	(7.4)	7.0	(6.6)	7.0	7.0	(7.2)	7.0	7.2	6.8	14.846	6.24		21.082

**R2-G1 Tatami 1 10:45(2022-10-04)**

Competitors	Kata	1T	1A	2T	2A	3T	3A	4T	4A	5T	5A	6T	6A	7T	7A	TEC	ATH	Extra	Total Rank
1 YEHEZKIEL TAMPANATU_ROTTOY (INKADO)	SUPARINPEI	(7.6)	(7.6)	7.4	(7.4)	(7.2)	(7.0)	7.4	7.2	(7.6)	7.4	(7.2)	7.2	7.2	(7.0)	15.4	6.54		21.945
2 MUHAMMAD KAHFI_N_R (GOJUKAI)	OHAN	(7.2)	7.2	7.2	(7.0)	(7.6)	(7.6)	(7.0)	7.2	(7.4)	(6.8)	7.4	(7.4)	7.2	7.0	15.266	6.42		21.686
3 AYMAN RAHMAT_ALBADI (INKANAS)	CHATANYARA KUSHANKU	(7.4)	7.2	(7.0)	(7.0)	7.4	7.2	(7.2)	(7.4)	(7.6)	(7.8)	7.4	(7.0)	7.4	7.2	15.546	6.48	22.2	024
4 ALVITO ABHISTA (BUDOKAI)	PAPUREN	(7.6)	(7.4)	(7.4)	(7.6)	7.4	(7.2)	(7.0)	(7.4)	(7.8)	7.4	7.4	7.4	7.4	7.4	15.546	6.66	22.2	2
5 MUHAMMAD AKIO_ZAIKO_IS (DKI JAKARTA)	UNSHU	(7.8)	(7.6)	(7.6)	(7.4)	7.6	(7.4)	(7.4)	(7.6)	(7.8)	7.4	7.6	7.6	7.6	7.4	15.966	7.2		22.681
6 ABYAN AL FADHI (INKAI)	KANKU SHO	(7.8)	(7.8)	(7.2)	7.4	(7.8)	(7.6)	7.6	7.4	(7.2)	(6.8)	7.2	7.4	7.2	(7.0)	15.4	6.66		22.063
7 KOMANG SASTRAWAN_LK (BALI)	UNSU	(7.4)	(7.2)	(7.2)	7.2	(7.0)	7.2	(7.0)	(7.4)	7.2	(6.8)	7.2	(7.0)	7.0	7.0	14.986	6.42		21.4
8 NABIL AZZURA_ASSIRIN_LK (SUMATERA BARAT A)	UNSU	(7.2)	(7.6)	7.2	(7.0)	(7.0)	7.0	7.2	(6.8)	(7.4)	(6.8)	(7.0)	6.8	7.0	7.0	14.986	6.24		21.228

**KEJUARAAN NASIONAL KARATE PIALA KETUA  
UMUM PB FORKI TAHUN 2022 - 2022-10-03  
JUNIOR KATA PERORANGAN PUTRA**

**R2-G2 Tatami 2 10:45(2022-10-04)**

Competitors	Kata	1T	1A	2T	2A	3T	3A	4T	4A	5T	5A	6T	6A	7T	7A	TEC	ATH	Extra	Total	Rank
1 MUHAMMAD REIHAN_FADILLAH_IN (KALIMANTAN SELATAN)		(6.8)	(7.0)	(7.2)	(7.2)	7.2	7.2	7.2	7.2	(7.6)	(7.8)	7.2	(7.0)	(7.4)	7.2	15.12	6.48		21.6	7
2 HAZEL RAMADHAN_IN (JAWA BARAT)		(7.4)	(7.6)	(7.8)	(8.0)	(7.6)	(7.6)	(7.8)	(7.8)	7.8	7.8	7.8	7.6	7.8	7.6	16.38	6.9		23.28	1
3 CHRISTOPHER EDBERT_SETIABUDI_SI (JAWA TENGAH)	SUPARINPEI	(7.2)	(7.4)	(7.4)	7.6	(8.0)	(8.2)	(8.0)	7.8	7.8	(8.0)	7.6	(7.4)	7.6	7.4	16.1	6.84		22.94	2
4 MUH ABY_MEZAR_GK (SULAWESI SELATAN)	CHATANYARA KUSHANKU	(7.8)	(7.8)	(7.6)	(7.6)	(7.4)	(7.2)	7.6	7.6	7.6	(7.8)	(7.4)	7.6	7.6	7.6	15.96	6.84		22.8	3
5 AHMAD WAHIDIN_SAPUTRA_IN (JAMBI)	SANSAI	(7.4)	(7.2)	(7.2)	(7.4)	7.2	(7.2)	7.4	7.2	(7.6)	(7.4)	(7.0)	7.2	7.4	7.2	15.4	6.48		21.88	5
6 FADHLIKA MONAZI_GK (SUMATERA BARAT B)		(7.0)	(7.0)	7.2	(7.0)	(7.4)	7.0	(7.4)	(7.4)	7.2	(7.2)	(7.0)	7.2	7.4	7.2	15.26	6.42		21.68	6
7 MOCHAMMAD NALENDRA_BUANA_FN (JAWA TIMUR)	KISHIMOTO NO KUSHANKU	(7.2)	(7.0)	(7.4)	7.4	7.4	(7.2)	(7.6)	7.4	7.4	(7.6)	7.4	7.6	(7.6)	(7.8)	15.54	6.72		22.26	4
8 NAFIS BUDI_RIANTO (SHOKAIDO)	SANSAI	(6.8)	(6.8)	7.2	(7.2)	(7.0)	(7.2)	(7.4)	7.2	7.2	7.2	7.0	(6.8)	(7.4)	7.2	14.98	6.48		21.46	8

**R3-G1 Tatami 1 11:35(2022-10-04)**

Competitors	Kata	1T	1A	2T	2A	3T	3A	4T	4A	5T	5A	6T	6A	7T	7A	TEC	ATH	Extra	Total	Rank
1 AYMAN RAHMAT_ALBADI (INKANAS)	CHIBANA NO KUSHANKU	(7.2)	7.4	(7.6)	(7.6)	(7.2)	(7.2)	7.2	7.4	7.2	7.2	7.2	(7.0)	(7.4)	(7.6)	15.12	6.6		21.72	4
2 ALVITO ABHISTA (BUDOKAI)	ANAN DAI	(7.4)	(7.2)	(7.4)	7.2	7.4	7.4	(7.6)	(7.6)	7.4	7.2	7.4	(7.0)	(7.6)	(7.8)	15.54	6.54		22.08	3
3 MUHAMMAD AKIO_ZAIKO_IS (DKI JAKARTA)	ANAN DAI	(7.6)	(7.6)	(7.6)	(7.4)	(8.0)	(7.8)	7.6	7.4	7.6	7.4	(7.4)	(7.2)	7.6	7.6	15.96	6.72		22.68	1
4 ABYAN AL_FADHI (INKAI)	GANKAKU	(7.8)	7.6	7.6	(7.8)	(7.8)	(7.8)	(7.4)	(7.4)	7.4	7.4	(7.2)	(7.2)	7.4	7.8	15.68	6.84		22.52	2

**R3-G2 Tatami 2 11:35(2022-10-04)**

Competitors	Kata	1T	1A	2T	2A	3T	3A	4T	4A	5T	5A	6T	6A	7T	7A	TEC	ATH	Extra	Total	Rank
1 MOCHAMMAD NALENDRA_BUANA_FN (JAWA TIMUR)		(7.2)	7.4	7.2	(7.2)	(7.4)	7.2	7.4	(7.6)	(7.6)	(7.6)	(7.0)	(7.0)	7.4	7.2	15.4	6.54		21.94	4
2 HAZEL RAMADHAN_IN (JAWA BARAT)	KISHIMOTO NO KUSHANKU	7.6	7.6	(7.4)	(7.4)	(7.8)	(7.8)	(7.8)	(7.8)	7.8	7.8	(7.4)	(7.4)	7.8	7.6	16.24	6.9		23.14	1
3 MUH ABY_MEZAR_GK (SULAWESI SELATAN)	CHIBANA NO KUSHANKU	(7.4)	7.6	(7.6)	7.8	7.6	(7.4)	7.6	(8.0)	(8.0)	(8.0)	(7.2)	(7.2)	7.6	7.4	15.96	6.84		22.8	2
4 CHRISTOPHER EDBERT_SETIABUDI_SI (JAWA TENGAH)	KISHIMOTO NO KUSHANKU	(7.4)	(7.4)	7.6	(7.2)	(8.0)	(7.8)	7.6	(7.6)	(7.8)	7.6	7.6	7.6	(7.4)	7.4	15.96	6.78		22.74	3

**R4 Bronze Medal Match 1 Tatami 1 12:15(2022-10-04)**

Competitors	Kata	1T	1A	2T	2A	3T	3A	4T	4A	5T	5A	6T	6A	7T	7A	TEC	ATH	Extra	Total	Rank
1 ABYAN AL_FADHI (INKAI)	UNSU	(7.0)	(7.2)	(7.4)	(7.4)	(7.8)	(7.8)	7.6	7.4	7.6	7.4	(7.8)	(7.8)	7.4	7.8	15.82	6.78		22.6	2
2 CHRISTOPHER EDBERT_SETIABUDI_SI (JAWA TENGAH)	ANAN DAI	(7.2)	(7.4)	(7.2)	(7.2)	7.6	(7.6)	7.6	7.6	(7.8)	7.6	(7.8)	(7.8)	7.6	7.6	15.96	6.84		22.8	1

**R4 Bronze Medal Match 2 Tatami 2 12:15(2022-10-04)**

Competitors	Kata	1T	1A	2T	2A	3T	3A	4T	4A	5T	5A	6T	6A	7T	7A	TEC	ATH	Extra	Total	Rank
1 ALVITO ABHISTA (BUDOKAI)	CHATANYARA KUSHANKU	(7.0)	(7.2)	(7.4)	7.2	(7.6)	(7.6)	(7.0)	(7.0)	7.2	7.2	7.4	(7.4)	7.4	7.2	15.4	6.48		21.88	2
2 MUH ABY_MEZAR_GK (SULAWESI SELATAN)	SUPARINPEI	7.8	7.8	7.8	7.8	(8.0)	(8.0)	(8.0)	(8.0)	(7.6)	(7.4)	(7.6)	(7.6)	7.8	7.8	16.38	7.02		23.4	1

**R4 Gold Medal Match Tatami 1 12:25(2022-10-04)**

Competitors	Kata	1T	1A	2T	2A	3T	3A	4T	4A	5T	5A	6T	6A	7T	7A	TEC	ATH	Extra	Total	Rank
1 MUHAMMAD AKIO_ZAIKO_IS (DKI JAKARTA)	CHATANYARA KUSHANKU	(8.2)	(7.8)	(8.2)	7.8	8.2	7.8	(8.0)	7.8	8.2	(8.2)	8.2	(8.0)	(7.6)	(7.4)	17.22	7.02		24.24	2
2 HAZEL RAMADHAN_IN (JAWA BARAT)	ANAN DAI	(8.4)	(8.4)	(7.6)	(7.8)	(8.6)	(8.2)	8.2	(8.4)	8.4	8.4	8.4	8.2	(8.0)	8.2	17.5	7.44		24.94	1

**Results**

1 HAZEL RAMADHAN IN	JAWA BARAT		INDONESIA
2 MUHAMMAD AKIO ZAIKO IS	DKI JAKARTA		INDONESIA
3 CHRISTOPHER EDBERT SETIABUDI SI	JAWA TENGAH		INDONESIA
3 MUH ABY MEZAR GK	SULAWESI SELATAN		INDONESIA
5 ABYAN AL FADHI	INKAI		INDONESIA
5 ALVITO ABHISTA	BUDOKAI		INDONESIA
7 AYMAN RAHMAT ALBADI	INKANAS		INDONESIA
7 MOCHAMMAD NALENDRA BUANA FN	JAWA TIMUR		INDONESIA

**KEJUARAAN NASIONAL KARATE PIALA KETUA  
UMUM PB FORKI TAHUN 2022 - 2022-10-03  
JUNIOR KATA PERORANGAN PUTRI**

**R1 G1/4 (7) Tatami 3 09:00(2022-10-04)**

Competitors	Kata	1T	1A	2T	2A	3T	3A	4T	4A	5T	5A	6T	6A	7T	7A	TEC	ATH	Extra	Total	Rank
1 WINDI LIANI_PUTRI_ID (JAMBI)	PAPUREN	(6.4)	(6.8)	7.2	(7.2)	(7.4)	7.0	(6.8)	6.8	6.8	(6.6)	(7.4)	(7.2)	7.2	7.0	14.84	6.24		21.085	
2 GUSTI_AGUNG_KETUT_ADINDA_BELIA (BANTEN)	GOJUSHIHO DAI LK	(6.8)	(7.0)	(7.0)	7.0	7.0	7.2	(7.2)	7.0	7.0	(6.8)	(7.2)	(7.4)	7.2	(7.4)	14.84	6.36		21.2	4
3 VEYORI YELLA_SALIM (INKANAS)	KANKU SHO	7.2	(7.4)	(6.8)	(6.8)	(7.4)	(7.6)	(7.4)	7.2	(7.0)	(7.0)	7.0	7.4	7.4	7.4	15.12	6.6		21.723	
4 REVA DEFINA_JESISKA_PRASWOYO_LANDAU (INKADO)	ANAN	(6.2)	(6.6)	(6.6)	(6.6)	7.0	6.8	(7.2)	(7.2)	6.6	6.6	6.8	6.6	(7.2)	(7.2)	14.28	6.0		20.287	
5 SYIFA AQILAH_WENADRA_IS (SUMATERA BARAT A)	PAPUREN	(7.6)	(7.6)	7.4	(7.4)	7.2	(7.2)	(7.6)	7.4	(6.8)	(6.8)	(7.0)	7.4	7.2	7.4	15.26	6.66		21.922	
6 KAYLA TAKBIRANI_IS (SULAWESI SELATAN)	PAPUREN	(7.4)	(7.8)	(7.8)	(7.8)	7.8	7.8	(7.4)	7.6	7.4	(7.2)	(8.0)	7.8	7.4	(7.4)	15.82	6.96		22.781	
7 MARCELLA IN (SUMATERA UTARA)	UNSU	(6.6)	6.6	(7.2)	(7.0)	(7.2)	6.6	7.0	6.8	(6.4)	(6.4)	6.6	(6.4)	6.8	(7.0)	14.28	6.0		20.286	

**R1 G2/4 (5) Tatami 3 09:50(2022-10-04)**

Competitors	Kata	1T	1A	2T	2A	3T	3A	4T	4A	5T	5A	6T	6A	7T	7A	TEC	ATH	Extra	Total	Rank
1 NABILLA NUR_APRILLIANI (KEI SHIN KAN)	CHIBANA NO KUSHANKU	(7.2)	(7.2)	7.2	7.2	(7.0)	7.2	(7.0)	(7.4)	7.0	(6.8)	(7.4)	(7.4)	7.2	7.2	14.98	6.48		21.464	
2 FAUZA RAMADHANI_IS (SULAWESI TENGAH)	PAPUREN	(7.4)	(7.2)	(7.2)	(7.0)	(7.2)	(6.8)	7.2	(7.2)	(7.0)	7.0	7.2	7.2	7.2	7.0	15.12	6.36		21.483	
3 LATIFAH HANUM (WADOKAI)	PAPUREN	(7.0)	(7.4)	(7.4)	7.2	(6.6)	(7.0)	7.4	(7.4)	(7.6)	7.4	7.4	7.4	7.0	(7.0)	15.26	6.6		21.862	
4 SHABRINA MARDHATILLAH (GOKASI)	SUPARINPEI	7.0	7.0	7.2	(7.4)	(7.4)	(7.2)	(6.8)	7.0	(6.8)	(6.6)	(7.4)	7.2	7.0	(6.8)	14.84	6.36		21.2	5
5 NABILA PUTRI_RAMADHANI (INKAI) (*2)	GOJUSHIHO DAI	(7.4)	(7.6)	7.4	(7.6)	(7.6)	(7.4)	7.6	7.6	(7.8)	7.4	(7.2)	7.4	7.4	(7.0)	15.68	6.72		22.4	1

**R1 G3/4 (7) Tatami 4 09:00(2022-10-04)**

Competitors	Kata	1T	1A	2T	2A	3T	3A	4T	4A	5T	5A	6T	6A	7T	7A	TEC	ATH	Extra	Total	Rank
1 AGHNIYA ZAMZAMI_IS (JAWA TIMUR)	PAPUREN	7.4	(6.8)	(7.2)	(7.0)	7.4	7.2	(7.8)	(7.6)	(7.8)	(7.6)	(7.2)	7.0	7.2	7.6	15.4	6.54		21.943	
2 ANANDITHA MUTIA_ZAHARA_S (GOJUKAI)	SUPARINPEI	(7.6)	(7.2)	7.4	7.2	(7.0)	(7.0)	(7.6)	7.2	7.6	(7.6)	(6.6)	7.2	7.2	(7.4)	15.54	6.48		22.022	
3 HALIZA NUR_IN (SUMATERA SELATAN)	UNSU	(7.0)	(6.4)	7.0	(6.8)	(7.2)	7.0	7.2	(7.2)	(7.4)	(7.6)	(6.8)	7.2	7.0	7.2	14.84	6.42		21.265	
4 NOVI YANTI_SAPITRI_LK (RIAU)	ANAN DAI	(6.8)	(6.4)	(7.4)	(7.2)	7.0	(7.2)	(6.8)	7.0	(7.4)	7.2	6.8	(6.8)	6.8	7.0	14.42	6.36		20.787	
5 ANDINI ALIFIAH_NURCAHYA (BUDOKAI)	CHIBANA NO KUSHANKU	(7.0)	(6.6)	(7.6)	(7.4)	(7.6)	(7.4)	7.2	7.4	7.4	(6.8)	(7.0)	7.4	7.4		15.4	6.66		22.061	
6 REVA MARSELA_IS (NTB)	GOJUSHIHO SHO	(7.2)	(6.8)	(6.8)	(6.6)	(7.2)	(7.4)	7.2	(7.4)	7.2	7.0	7.2	7.2	(7.4)	7.2	15.12	6.42		21.544	
7 SYEERIN RAMADANI_S_IS (KALIMANTAN TIMUR)	UNSU	(6.8)	(6.4)	(7.0)	(6.8)	(7.0)	6.8	(7.2)	6.8	7.0	(7.0)	7.0	6.8	7.0	(7.0)	14.7	6.12		20.826	

**R1 G4/4 (6) Tatami 4 09:50(2022-10-04)**

Competitors	Kata	1T	1A	2T	2A	3T	3A	4T	4A	5T	5A	6T	6A	7T	7A	TEC	ATH	Extra	Total	Rank
1 BUNGA APRILIA (LEMKARI)	GOJUSHIHO SHO	(7.0)	(7.2)	(7.4)	(7.2)	(7.0)	7.2	7.0	(7.0)	7.2	(7.0)	(7.4)	7.2	7.4	7.2	15.12	6.48		21.6	3
2 GEUBRINA NAJWA_ANDINI_GD (ACEH)	ANAN DAI	(6.8)	(6.8)	(7.2)	7.0	(6.8)	7.0	6.8	(6.8)	(7.4)	(7.2)	7.0	7.0	7.2	(7.2)	14.7	6.3		21.0	5
3 SITI MUTIA_IBROS_HUSAINI (FUNAKOSHI)	GOJUSHIHO SHO	(6.2)	(6.6)	(7.2)	(6.8)	(6.4)	6.4	6.2	6.2	6.2	(6.0)	6.4	6.2	(6.0)	(6.0)	13.16	5.64		18.8	6
4 DEWI AFRIZKA_ZUABARIANTI_IS (SULAWESI BARAT)	PAPUREN	(6.8)	6.8	(7.2)	(7.0)	7.2	(6.6)	7.2	(7.2)	(6.8)	(6.6)	7.2	6.8	(7.4)	7.0	15.12	6.18		21.3	4
5 SHELOMITHA LIE_HOSANG_ID (SULAWESI UTARA)	PAPUREN	(6.8)	(7.0)	(7.4)	(7.4)	(7.4)	7.2	7.4	(7.4)	(7.0)	(6.8)	7.2	7.2	7.2	7.2	15.26	6.48		21.742	
6 BEATRIX HELENA_PANGEMANAN_GK (DKI JAKARTA) (*1)	ANAN	(7.4)	(7.4)	(7.6)	7.4	(7.6)	(7.6)	7.6	(7.6)	(7.4)	(7.2)	7.4	7.4	7.4	7.4	15.68	6.66		22.341	

**R2-G1 Tatami 3 10:40(2022-10-04)**

Competitors	Kata	1T	1A	2T	2A	3T	3A	4T	4A	5T	5A	6T	6A	7T	7A	TEC	ATH	Extra	Total	Rank
1 NABILLA NUR_APRILLIANI (KEI SHIN KAN)	PAPUREN	7.4	(7.2)	(7.6)	(7.4)	(7.2)	7.4	7.2	7.2	(7.6)	(7.6)	7.4	7.2	(7.0)	(7.0)	15.4	6.54		21.943	
2 NABILA PUTRI_RAMADHANI (INKAI)	GOJUSHIHO	7.6	(7.8)	(7.8)	7.6	(7.8)	(7.8)	(7.0)	(6.8)	(7.0)	(7.0)	7.4	7.6	7.6	7.8	15.82	6.9		22.721	
3 KAYLA TAKBIRANI_IS (SULAWESI SELATAN)	ANAN DAI	(7.4)	(7.6)	(7.8)	7.4	7.4	(7.0)	7.4	7.2	7.4	(7.2)	(7.0)	(7.8)	(7.8)		15.54	6.6		22.142	
4 GUSTI_AGUNG_KETUT_ADINDA_BELIA (BANTEN)	GANKAKU	(7.0)	(7.2)	(7.4)	(7.2)	(6.8)	7.0	6.8	(6.8)	6.8	(6.8)	7.0	7.0	(6.6)	7.0	14.42	6.3		20.728	
5 LATIFAH HANUM (WADOKAI)	ANAN DAI	(7.0)	(7.4)	7.2	7.4	(7.4)	7.4	(6.8)	(6.6)	(7.8)	(7.8)	7.4	7.4	7.2	(7.2)	15.26	6.66		21.924	
6 VEYORI YELLA_SALIM (INKANAS)	GOJUSHIHO DAI	(7.2)	6.8	7.2	7.0	(7.6)	(7.6)	(6.6)	(6.6)	(6.6)	(6.6)	7.2	7.2	7.2	(7.4)	15.12	6.3		21.426	
7 SYIFA AQILAH_WENADRA_IS (SUMATERA BARAT A)	ANAN DAI	(7.0)	(6.8)	(7.4)	(7.4)	7.2	7.2	(6.6)	(6.4)	7.2	7.2	(7.4)	(7.4)	7.2	7.4	15.12	6.54		21.665	
8 FAUZA RAMADHANI_IS (SULAWESI TENGAH)	SUPARINPEI	6.8	6.6	(7.4)	(7.6)	6.8	7.2	(6.4)	(6.2)	(6.4)	(6.4)	(7.2)	(7.4)	7.0	7.4	14.42	6.36		20.787	

**R2-G2 Tatami 4 10:40(2022-10-04)**

Competitors	Kata	1T	1A	2T	2A	3T	3A	4T	4A	5T	5A	6T	6A	7T	7A	TEC	ATH	Extra	Total	Rank
1 AGHNIYA ZAMZAMI_IS (JAWA TIMUR)	OYADOMARI NO PASSAI	(7.4)	(7.4)	(6.8)	(7.2)	7.4	(7.0)	(7.2)	7.4	7.2	(7.6)	7.2	7.2	(7.6)	7.2	15.26	6.54		21.8	4
2 REVA MARSELA_IS (NTB)	UNSU	(7.2)	(7.2)	(6.8)	(7.0)	7.2	7.0	(7.4)	7.0	(7.0)	(7.2)	7.0	7.2	7.2	(6.8)	14.98	6.36		21.346	
3 ANANDITHA MUTIA_ZAHARA_S (GOJUKAI)	ANAN DAI	7.4	(7.2)	(6.8)	(6.8)	(7.6)	(7.6)	(7.2)	(7.4)	7.2	7.4	7.2	7.4	(7.6)	7.2	15.26	6.6		21.863	

**KEJUARAAN NASIONAL KARATE PIALA KETUA  
UMUM PB FORKI TAHUN 2022 - 2022-10-03  
JUNIOR KATA PERORANGAN PUTRI**

4	ANDINI ALIFIAH_NURCAHYA (BUDOKAI)	CHATANYARA KUSHANKU	7.6	(7.6)	(6.8)	(7.2)	(7.8)	(7.6)	(7.4)	(7.4)	7.6	7.4	7.6	7.4	(7.8)	7.4	15.96	6.66	22.62	1
5	DEWI AFRIZKA_ZUABARIANTI_IS (SULAWESI BARAT)		(7.0)	(6.8)	(6.6)	6.8	(7.2)	(7.0)	7.0	6.8	6.8	(7.0)	(6.6)	6.8	6.6	(6.2)	14.28	6.12	20.4	8
6	BUNGA APRILIA (LEMKARI)	KANKU SHO	7.2	(7.0)	(6.6)	7.0	(7.4)	(7.2)	(7.0)	(6.8)	7.0	7.0	7.0	(7.2)	(7.4)	7.2	14.84	6.36	21.2	7
7	SHELOMITHA LIE_HOSANG_ID (SULAWESI UTARA)	SUPARINPEI	(7.4)	(7.2)	(7.0)	(7.0)	7.2	(7.0)	7.2	7.2	(7.0)	7.2	(7.4)	(7.4)	7.2	7.0	15.12	6.42	21.54	5
8	BEATRIX HELENA_PANGEMANAN_GK (DKI JAKARTA)	PAPUREN	(7.6)	(7.8)	(7.4)	(7.2)	(7.6)	7.4	7.6	7.4	(7.4)	(7.6)	7.4	7.6	7.4	(7.0)	15.68	6.72	22.4	2

**R3-G1 Tatami 3 11:25(2022-10-04)**

Competitors	Kata	1T	1A	2T	2A	3T	3A	4T	4A	5T	5A	6T	6A	7T	7A	TEC	ATH	Extra	Total	Rank
1	LATIFAH HANUM (WADOKAI)	CHATANYARA KUSHANKU	(7.6)	(7.6)	(7.4)	(7.4)	(7.4)	(7.4)	7.4	7.4	(7.2)	7.4	7.4	7.4	7.4	15.54	6.66	22.2	3	
2	KAYLA TAKBIRANI_IS (SULAWESI SELATAN)	CHIBANA NO KUSHANKU	(7.2)	(7.2)	(7.2)	(7.4)	7.2	7.6	(7.8)	(7.8)	7.4	7.4	7.2	7.4	(7.6)	(7.8)	15.26	6.72	21.98	4
3	NABILLA NUR_APRILLIANI (KEI SHIN KAN)	CHATANYARA KUSHANKU	7.4	(7.4)	(7.6)	7.4	7.4	(7.2)	(7.6)	7.4	(7.2)	7.4	7.6	(7.6)	(7.2)	(7.2)	15.68	6.66	22.34	2
4	NABILA PUTRI_RAMADHANI (INKAI)	UNSU	(7.0)	(7.0)	(7.6)	(7.8)	7.6	(7.8)	(7.8)	7.6	(7.4)	7.4	7.4	7.4	7.6	(7.2)	15.82	6.72	22.54	1

**R3-G2 Tatami 4 11:25(2022-10-04)**

Competitors	Kata	1T	1A	2T	2A	3T	3A	4T	4A	5T	5A	6T	6A	7T	7A	TEC	ATH	Extra	Total	Rank
1	ANDINI ALIFIAH_NURCAHYA (BUDOKAI)	PAPUREN	(7.4)	(7.4)	(7.6)	(7.4)	7.4	7.4	7.6	7.4	7.6	7.4	(6.8)	(7.0)	(8.4)	(8.2)	15.82	6.66	22.48	2
2	ANANDITHA MUTIA_ZAHARA_S (GOJUKAI)	CHIBANA NO KUSHANKU	(7.2)	(7.4)	7.2	(7.2)	(7.0)	(7.2)	(7.4)	7.2	7.4	7.2	7.2	(7.6)	(8.0)	15.26	6.54	21.8	3	
3	BEATRIX HELENA_PANGEMANAN_GK (DKI JAKARTA)	KURURUNFA	(7.6)	(7.4)	(7.4)	7.4	7.6	(7.6)	(7.4)	7.4	7.6	7.6	7.4	(7.2)	(8.2)	(8.0)	15.82	6.72	22.54	1
4	AGHNNIA ZAMZAMI_IS (JAWA TIMUR)	GOJUSHIHO DAI	(7.2)	7.2	7.2	7.2	(6.8)	(7.0)	6.8	7.0	7.0	(6.8)	(6.6)	(7.4)	(7.8)	(7.8)	14.7	6.42	21.12	4

**R4 Bronze Medal Match 1 Tatami 3 11:50(2022-10-04)**

Competitors	Kata	1T	1A	2T	2A	3T	3A	4T	4A	5T	5A	6T	6A	7T	7A	TEC	ATH	Extra	Total	Rank
1	NABILLA NUR_APRILLIANI (KEI SHIN KAN)	SUPARINPEI	7.4	(7.4)	7.4	(7.2)	(7.2)	(7.0)	(7.6)	7.2	(7.2)	7.4	(7.8)	(7.6)	7.2	7.4	15.4	6.6	22.0	2
2	ANANDITHA MUTIA_ZAHARA_S (GOJUKAI)	PAPUREN	(7.8)	(7.8)	(7.6)	(7.4)	(7.4)	(7.2)	(8.0)	7.6	7.6	7.6	7.6	(7.8)	7.8	7.6	16.1	6.84	22.94	1

**R4 Bronze Medal Match 2 Tatami 4 11:50(2022-10-04)**

Competitors	Kata	1T	1A	2T	2A	3T	3A	4T	4A	5T	5A	6T	6A	7T	7A	TEC	ATH	Extra	Total	Rank
1	LATIFAH HANUM (WADOKAI)	WANSU	(7.4)	(7.0)	(7.0)	(7.2)	(7.2)	(7.2)	7.2	(7.4)	7.2	7.2	(7.0)	7.2	7.0	15.12	6.42	21.54	2	
2	ANDINI ALIFIAH_NURCAHYA (BUDOKAI)	SUPARINPEI	(7.8)	(7.4)	(7.4)	(7.4)	(7.6)	(7.6)	7.6	(7.6)	(7.4)	7.4	7.6	7.4	7.4	15.82	6.66	22.48	1	

**R4 Gold Medal Match Tatami 3 12:00(2022-10-04)**

Competitors	Kata	1T	1A	2T	2A	3T	3A	4T	4A	5T	5A	6T	6A	7T	7A	TEC	ATH	Extra	Total	Rank
1	NABILA PUTRI_RAMADHANI (INKAI)	GANKAKU	(7.6)	7.6	(7.2)	(7.2)	(8.4)	(8.4)	7.6	7.6	7.6	(7.8)	(7.2)	(7.4)	7.6	7.6	15.96	6.84	22.8	2
2	BEATRIX HELENA_PANGEMANAN_GK (DKI JAKARTA)	ANAN DAI	(8.0)	(8.0)	(7.4)	(7.4)	(8.2)	(8.2)	7.8	8.0	8.0	7.8	(7.6)	7.6	7.8	(7.4)	16.52	7.02	23.54	1

**Results**

1	BEATRIX HELENA PANGEMANAN GK	DKI JAKARTA		INDONESIA
2	NABILA PUTRI RAMADHANI	INKAI		INDONESIA
3	ANANDITHA MUTIA ZAHARA S	GOJUKAI		INDONESIA
3	ANDINI ALIFIAH NURCAHYA	BUDOKAI		INDONESIA
5	NABILLA NUR APRILLIANI	KEI SHIN KAN		INDONESIA
5	LATIFAH HANUM	WADOKAI		INDONESIA
7	KAYLA TAKBIRANI IS	SULAWESI SELATAN		INDONESIA
7	AGHNNIA ZAMZAMI IS	JAWA TIMUR		INDONESIA

**KEJUARAAN NASIONAL KARATE PIALA KETUA  
UMUM PB FORKI TAHUN 2022 - 2022-10-03  
KADET KATA PERORANGAN PUTRA**

**R1 G1/4 (7) Tatami 1 10:30(2022-10-03)**

Competitors	Kata	1T	1A	2T	2A	3T	3A	4T	4A	5T	5A	6T	6A	7T	7A	TEC	ATH	Extra	Total	Rank
1 SABIL NUR_RAMADHAN_IN (KALIMANTAN TIMUR)	UNSU	(7.2)	(7.4)	(7.4)	(7.2)	(7.2)	7.2	7.2	(6.8)	7.2	7.2	7.2	7.2	(7.0)	(7.0)	15.126	6.48		21.6	2
2 ABEL ALDRICH_IN (JAMBI)	UNSU	7.4	(7.6)	7.2	7.4	(7.6)	(7.6)	7.2	(7.0)	(7.0)	(7.0)	(7.6)	7.4	(7.0)	7.0	15.266	6.54		21.8	1
3 M IRHAM_ABDILLAH (GOJUKAI)	SUPARINPEI	(6.6)	(6.8)	7.0	(6.8)	(7.6)	(7.4)	(6.8)	6.8	7.0	(6.6)	7.0	6.8	(7.2)	6.8	14.7	6.12		20.824	
4 TELEKA SITEPU (GABDIKA SHITORYUKAI)	CHATANYARA KUSHANKU	(6.4)	(6.6)	(7.0)	7.0	(7.4)	(7.4)	7.0	(7.2)	(6.6)	(6.8)	6.8	6.8	6.8	6.8	14.426	6.18		20.6	5
5 AHMAD YUDHA_PRATAMA_ASIKIN (KEI SHIN KAN)	CHATANYARA KUSHANKU	(6.8)	7.0	(7.2)	(7.2)	(7.2)	(7.4)	7.0	(6.6)	6.8	(6.6)	6.8	6.6	(6.6)	6.8	14.426	6.12		20.546	
6 RADITYA IN (SULAWESI TENGAH)																				
7 BINTANG TESA_HARIYANTO_AS (SUMATERA BARAT A) (*4)	KANKU SHO	(7.0)	7.2	(7.6)	(7.4)	(7.6)	(7.6)	7.2	7.0	(6.8)	(6.8)	7.4	7.2	7.0	(6.4)	15.126	6.42		21.543	

**R1 G2/4 (7) Tatami 1 11:30(2022-10-03)**

Competitors	Kata	1T	1A	2T	2A	3T	3A	4T	4A	5T	5A	6T	6A	7T	7A	TEC	ATH	Extra	Total	Rank
1 HASBI IRAWAN_IS (JAWA BARAT)	CHATANYARA KUSHANKU	(7.0)	(7.2)	7.0	(6.8)	(6.8)	(6.8)	7.2	7.0	7.2	7.2	(7.4)	(7.4)	(7.4)	7.2	14.986	6.42		21.4	3
2 HARAY SHOKE_LAMINDO_GA (LAMPUNG)	PAPUREN	7.2	7.2	7.2	(7.4)	(6.4)	(6.4)	(7.0)	(6.8)	7.0	6.8	(7.6)	7.4	(7.4)	(7.6)	14.986	6.42		21.4	4
3 IRFAN ANWAR_SONDAKH_LK (SULAWESI UTARA)	UNSU	(6.6)	6.8	6.8	(7.0)	(6.6)	(6.6)	6.8	(6.6)	6.8	6.8	(7.0)	(7.0)	(7.2)	7.0	14.286	6.18		20.466	
4 ARIQ MAULANA_FARUQ_IBRAHIM_IN (SUMATERA SELATAN)	UNSU	(6.0)	(6.2)	(6.2)	6.2	6.4	(6.0)	(6.6)	(6.6)	6.6	6.4	6.2	6.2	(6.8)	(6.8)	13.445	5.64		19.087	
5 I KETUT_VICKY_MAHARDIKA_LK (BALI)		(7.2)	(7.4)	(6.6)	6.6	7.0	(7.0)	(6.4)	(6.4)	7.2	7.0	6.6	(6.4)	(7.4)	7.0	14.566	6.18		20.745	
6 VALENT OLIVER_CAN_GK (JAWA TENGAH)		(7.4)	7.4	(7.4)	(7.6)	(7.2)	(7.0)	7.4	(7.2)	7.4	7.4	(7.2)	7.2	7.4	(7.6)	15.546	6.6		22.141	
7 MUHAMMAD PASYA_ARDIANSYAH_IN (DKI JAKARTA) (*2)		(7.4)	(7.6)	(7.4)	7.2	(6.8)	(7.0)	7.4	(7.4)	(7.0)	7.2	7.2	(7.0)	7.2	7.2	15.266	6.48		21.742	

**R1 G3/4 (7) Tatami 2 10:30(2022-10-03)**

Competitors	Kata	1T	1A	2T	2A	3T	3A	4T	4A	5T	5A	6T	6A	7T	7A	TEC	ATH	Extra	Total	Rank
1 FARIS UKMALI_IS (ACEH)	PAPUREN	(6.6)	(6.4)	(6.8)	(6.6)	6.8	6.8	7.0	6.8	(7.4)	7.0	(7.4)	(7.2)	7.2	(7.4)	14.7	6.18		20.884	
2 KHAIRUL IHSAN (GOKASI)	KANKU SHO	(6.4)	(6.2)	(6.6)	6.6	6.6	(6.4)	6.8	6.6	(7.0)	(7.2)	(7.4)	(7.4)	7.0	7.0	14.286	6.06		20.346	
3 TSAQIF WADI_RAMADHAN_IN (RIAU)	UNSU	6.8	(6.6)	6.8	6.8	(6.4)	(6.6)	(6.6)	6.6	7.0	7.0	(7.6)	(7.6)	(7.4)	(7.2)	14.426	6.12		20.545	
4 RAIHAN DHIYA_SYAUQI (INKADO)	UNSU	(6.6)	6.6	7.0	6.6	(6.2)	(6.4)	7.0	(6.4)	(7.4)	7.2	(7.6)	(7.8)	7.4	(7.6)	14.986	6.12		21.1	3
5 RAZENDRA RAKA_MUFTI (WADOKAI)	ANAN DAI	(6.2)	(6.0)	6.4	(6.2)	(6.2)	6.2	(6.8)	6.2	6.8	(7.0)	(7.2)	(7.2)	6.8	7.0	14.0	5.82		19.827	
6 SATRIA NURWAHYU (BUDOKAI)	SUPARINPEI	(7.4)	(7.2)	7.4	7.4	7.4	7.4	(7.2)	(7.0)	7.4	7.2	(7.6)	(7.6)	(7.6)	(7.8)	15.546	6.6		22.141	
7 TAUFIK AKBAR_GK (SUMATERA BARAT B) (*3)	SUPARINPEI	(7.2)	7.2	7.2	(7.0)	7.2	7.2	(7.0)	(6.4)	7.2	7.2	(7.8)	(7.8)	(7.4)	(7.6)	15.126	6.48		21.6	2

**R1 G4/4 (7) Tatami 2 11:30(2022-10-03)**

Competitors	Kata	1T	1A	2T	2A	3T	3A	4T	4A	5T	5A	6T	6A	7T	7A	TEC	ATH	Extra	Total	Rank
1 MOH RIZKY_SUDARMONO_WK (GORONTALO)	ANAN DAI	(7.2)	(7.2)	(7.0)	(7.0)	(7.2)	(7.0)	7.2	7.0	7.2	7.0	(6.6)	(6.4)	7.2	7.0	15.126	6.3		21.424	
2 M DHIJEY_LEXSIE_SI (SUMATERA UTARA)	ANAN	7.0	(7.2)	(7.4)	(7.2)	(7.4)	7.2	7.0	(6.8)	7.0	7.0	(6.6)	(6.6)	(6.8)	7.0	14.7	6.36		21.065	
3 GHALLAH ATTHARIEQSYAH_ID (KEPULAUAN RIAU)	ANAN DAI	(7.2)	(7.4)	(7.0)	(6.8)	7.0	6.8	(6.8)	(7.0)	7.0	6.8	(6.4)	(6.2)	7.0	6.8	14.7	6.12		20.826	
4 NAUFAL PUTRA_DIANDRA (INKAI)	KANKU SHO	7.4	(7.6)	7.4	(7.2)	(7.6)	7.4	7.4	7.2	(6.8)	7.2	(6.8)	(6.8)	(7.8)	(7.8)	15.546	6.54		22.082	
5 VICTOR BELVA_ANANTA_NURRACHMAN_IN (JAWA TIMUR)	KANKU SHO	(7.6)	(7.8)	7.4	7.4	7.4	7.4	7.4	7.4	(6.8)	(6.8)	(6.6)	(6.4)	(7.6)	(7.8)	15.546	6.66		22.2	1
6 RAHMAT H (SHIROITE)	UNSU	(6.8)	6.8	(7.0)	(7.0)	6.8	(7.0)	6.8	(6.6)	6.8	6.6	(6.2)	(6.0)	(7.0)	6.6	14.286	6.0		20.287	
7 BAGASKARA EDYTIA_PUTRA_IN (KALIMANTAN SELATAN) (*1)	KANKU SHO	(7.6)	(7.6)	(7.4)	(7.4)	(7.2)	(6.8)	7.4	7.2	7.2	7.2	(7.0)	(6.8)	7.4	7.2	15.4	6.48		21.883	

**R2-G1 Tatami 1 12:20(2022-10-03)**

Competitors	Kata	1T	1A	2T	2A	3T	3A	4T	4A	5T	5A	6T	6A	7T	7A	TEC	ATH	Extra	Total	Rank
1 HASBI IRAWAN_IS (JAWA BARAT)	UNSHU	7.2	7.4	(7.8)	(7.8)	7.4	(7.2)	(6.8)	(7.2)	(7.6)	(7.6)	7.2	7.4	(7.0)	7.2	15.266	6.6		21.866	
2 M IRHAM_ABDILLAH (GOJUKAI)	ANAN DAI	(7.4)	(7.2)	(7.8)	(7.8)	(7.2)	(7.4)	(7.0)	7.2	7.4	7.4	7.2	7.2	(7.0)	(7.0)	15.4	6.54		21.945	
3 MUHAMMAD PASYA_ARDIANSYAH_IN (DKI JAKARTA)	KANKU SHO	7.4	(7.4)	(7.8)	(7.6)	7.4	(6.8)	(6.8)	(7.0)	(7.8)	7.4	(7.2)	7.2	7.4	7.2	15.546	6.54		22.082	
4 VALENT OLIVER_CAN_GK (JAWA TENGAH)	CHIBANA NO KUSHANKU	(7.6)	(7.4)	(7.4)	(7.6)	7.4	(7.0)	(7.2)	(7.2)	(7.6)	7.2	7.6	7.4	7.4	7.2	15.686	6.54		22.221	
5 ABEL ALDRICH_IN (JAMBI)	SANSAI	(7.8)	7.4	(7.8)	(7.8)	(7.2)	(7.2)	(7.0)	7.4	7.2	7.2	7.6	(7.6)	7.2	(7.0)	15.4	6.6		22.0	4
6 SABIL NUR_RAMADHAN_IN (KALIMANTAN TIMUR)	GANKAKU	(7.6)	(7.6)	(7.8)	(7.6)	7.4	7.2	(7.2)	7.4	(7.0)	(7.0)	7.2	7.0	7.2	(6.8)	15.266	6.48		21.747	
7 HARAY SHOKE_LAMINDO_GA (LAMPUNG)	ANAN DAI	(7.4)	(7.4)	(7.2)	(7.2)	(7.4)	(7.4)	7.4	7.4	7.4	7.2	7.4	7.2	(7.2)	(6.8)	15.546	6.54		22.083	
8 BINTANG TESA_HARIYANTO_AS (SUMATERA BARAT A)	GANKAKU	(7.6)	(7.2)	(7.6)	7.2	7.2	(7.4)	7.2	(6.8)	(7.0)	6.8	7.0	6.8	(6.8)	(6.6)	14.986	6.24		21.228	

**R2-G2 Tatami 2 12:20(2022-10-03)**

Competitors	Kata	1T	1A	2T	2A	3T	3A	4T	4A	5T	5A	6T	6A	7T	7A	TEC	ATH	Extra	Total	Rank
1 SATRIA NURWAHYU (BUDOKAI)	ANAN	(7.6)	(7.4)	(7.4)	7.4	(7.6)	7.4	(7.4)	(7.2)	7.4	7.4	7.6	(7.6)	7.6	(7.2)	15.826	6.66		22.481	

**KEJUARAAN NASIONAL KARATE PIALA KETUA  
UMUM PB FORKI TAHUN 2022 - 2022-10-03  
KADET KATA PERORANGAN PUTRA**

2	VICTOR BELVA ANANTA_NURRACHMAN_IN (JAWA TIMUR)	GANKAKU	(7.8)	(7.6)	(7.2)	(7.0)	(7.2)	(7.0)	(7.6)	7.4	7.6	7.6	7.4	(7.8)	7.4	7.2	15.68	6.66		22.34	2
3	BAGASKARA EDYTIA_PUTRA_IN (KALIMANTAN SELATAN)	GOJUSHIHO SHO	(7.8)	(7.8)	(7.2)	7.4	(7.2)	(7.0)	7.2	(7.2)	(7.6)	(7.8)	7.2	7.4	7.4	7.6	15.26	6.72		21.98	6
4	NAUFAL PUTRA_DIANDRA (INKAI)	GOJUSHIHO SHO	(8.0)	(7.8)	7.4	7.2	(7.0)	(7.0)	(7.2)	(7.0)	7.6	(7.6)	(7.8)	7.4	7.4	7.4	15.68	6.6		22.28	3
5	FARIS UKMALI_IS (ACEH)	UNSU	(7.6)	(7.6)	(6.8)	(7.0)	(7.2)	(7.2)	7.4	7.4	(7.6)	(7.8)	7.4	7.4	7.2	7.4	15.4	6.66		22.06	4
6	MOH RIZKY_SUDARMONO_WK (GORONTALO)	ANAN DAI	(7.2)	(7.2)	(7.0)	(6.8)	(6.8)	(6.8)	7.2	7.0	(7.6)	(7.4)	7.2	7.0	7.2	7.0	15.12	6.3		21.42	8
7	TAUFIK AKBAR_GK (SUMATERA BARAT B)	ANAN DAI	(7.4)	(7.4)	7.2	7.2	(6.8)	(6.6)	7.2	(7.0)	(7.8)	(7.6)	(7.0)	7.0	7.4	7.4	15.26	6.48		21.74	7
8	RAIHAN DHIYA_SYAUQI (INKADO)	ANAN DAI	(7.4)	7.2	(6.8)	(6.8)	7.4	(7.0)	7.4	(7.4)	(7.8)	(7.8)	(6.8)	7.2	7.4	7.2	15.54	6.48		22.02	5

**R3-G1 Tatami 1 13:10(2022-10-03)**

Competitors	Kata	1T	1A	2T	2A	3T	3A	4T	4A	5T	5A	6T	6A	7T	7A	TEC	ATH	Extra	Total Rank	
1 MUHAMMAD PASYA_Ardiansyah_IN (DKI JAKARTA)		(7.6)	(7.4)	(7.2)	(7.4)	(7.4)	(7.2)	7.4	7.4	(7.2)	(7.0)	7.4	7.4	7.4	7.4	15.54	6.66		22.2	1
2 HARAY SHOKE_LAMINDO_GA (LAMPUNG)		(7.4)	(7.2)	7.2	7.0	(7.0)	(6.8)	(7.6)	(7.6)	(7.0)	(6.8)	7.2	7.0	7.4	7.2	15.26	6.36		21.62	3
3 ABEL ALDRICH_IN (JAMBI)		(7.2)	(7.4)	7.2	7.2	(6.6)	(6.6)	7.2	(7.0)	(7.0)	7.0	(7.6)	(7.6)	7.2	7.0	15.12	6.36		21.48	4
4 VALENT OLIVER_CAN_GK (JAWA TENGAH)		(7.8)	(7.6)	(7.0)	(7.2)	7.4	7.4	(7.2)	(7.2)	7.4	7.4	7.2	7.4	(7.6)	(7.6)	15.4	6.66		22.06	2

**R3-G2 Tatami 2 13:10(2022-10-03)**

Competitors	Kata	1T	1A	2T	2A	3T	3A	4T	4A	5T	5A	6T	6A	7T	7A	TEC	ATH	Extra	Total Rank	
1 NAUFAL PUTRA_DIANDRA (INKAI)		(7.6)	(7.8)	(7.8)	(7.6)	(7.6)	(7.4)	7.6	7.4	7.6	7.4	7.6	7.6	(7.0)	(7.2)	15.96	6.72		22.68	1
2 VICTOR BELVA ANANTA_NURRACHMAN_IN (JAWA TIMUR)		(7.4)	(7.6)	(7.0)	(6.8)	7.4	(7.0)	7.4	7.2	7.4	7.2	(7.6)	(7.4)	(7.2)	7.2	15.54	6.48		22.02	3
3 SATRIA NURWAHYU (BUDOKAI)		(7.6)	(7.6)	(7.6)	(7.4)	(7.4)	(6.8)	(7.4)	(7.2)	7.4	7.4	7.4	7.2	7.4	7.2	15.54	6.54		22.08	2
4 FARIS UKMALI_IS (ACEH)		(7.4)	(7.4)	(7.2)	(7.0)	(7.0)	(6.6)	(7.2)	7.2	7.2	7.2	(7.4)	7.2	7.0	7.0	15.12	6.42		21.54	4

**R4 Bronze Medal Match 1 Tatami 1 13:35(2022-10-03)**

Competitors	Kata	1T	1A	2T	2A	3T	3A	4T	4A	5T	5A	6T	6A	7T	7A	TEC	ATH	Extra	Total Rank	
1 VALENT OLIVER_CAN_GK (JAWA TENGAH)		(7.4)	(7.4)	(7.4)	(7.2)	(7.6)	(7.6)	7.4	7.4	(7.6)	7.4	7.4	(7.2)	7.6	7.4	15.68	6.66		22.34	2
2 VICTOR BELVA ANANTA_NURRACHMAN_IN (JAWA TIMUR)		(7.8)	7.6	7.6	(7.4)	(7.8)	(8.0)	7.6	(7.8)	(7.4)	(7.4)	7.6	7.4	(7.4)	7.4	15.96	6.72		22.68	1

**R4 Bronze Medal Match 2 Tatami 2 13:35(2022-10-03)**

Competitors	Kata	1T	1A	2T	2A	3T	3A	4T	4A	5T	5A	6T	6A	7T	7A	TEC	ATH	Extra	Total Rank	
1 HARAY SHOKE_LAMINDO_GA (LAMPUNG)		(7.4)	(7.4)	(7.4)	(7.2)	(7.8)	(8.0)	7.4	7.4	7.4	7.4	(7.2)	7.4	7.4	(7.6)	15.54	6.66		22.2	1
2 SATRIA NURWAHYU (BUDOKAI)		(7.2)	(7.2)	(7.2)	7.2	(7.6)	(7.8)	(7.4)	(7.6)	7.4	(7.0)	7.2	7.2	7.2	7.2	15.26	6.48		21.74	2

**R4 Gold Medal Match Tatami 1 13:45(2022-10-03)**

Competitors	Kata	1T	1A	2T	2A	3T	3A	4T	4A	5T	5A	6T	6A	7T	7A	TEC	ATH	Extra	Total Rank	
1 MUHAMMAD PASYA_Ardiansyah_IN (DKI JAKARTA)		(7.4)	(7.2)	(7.2)	7.2	(7.0)	(7.0)	(7.6)	(7.6)	7.4	7.4	7.2	7.4	7.4	(7.6)	15.4	6.6		22.0	2
2 NAUFAL PUTRA_DIANDRA (INKAI)	GANKAKU	(7.8)	7.6	(7.6)	7.6	(7.2)	(7.0)	(7.8)	(7.8)	7.6	(7.4)	7.6	7.4	7.8	(7.8)	16.1	6.78		22.88	1

**Results**

1	NAUFAL PUTRA DIANDRA	INKAI		INDONESIA
2	MUHAMMAD PASYA ARDIANSYAH IN	DKI JAKARTA		INDONESIA
3	VICTOR BELVA ANANTA NURRACHMAN IN	JAWA TIMUR		INDONESIA
3	HARAY SHOKE LAMINDO GA	LAMPUNG		INDONESIA
5	VALENT OLIVER CAN GK	JAWA TENGAH		INDONESIA
5	SATRIA NURWAHYU	BUDOKAI		INDONESIA



**KEJUARAAN NASIONAL KARATE PIALA KETUA  
UMUM PB FORKI TAHUN 2022 - 2022-10-03  
KADET KATA PERORANGAN PUTRI**

**R1 G1/2 (9) Tatami 3 10:30(2022-10-03)**

Competitors	Kata	1T	1A	2T	2A	3T	3A	4T	4A	5T	5A	6T	6A	7T	7A	TEC	ATH	Extra	Total Rank
1 GUMAYANG FITRI_LK (BENGKULU)	ANAN	(6.2)	(6.2)	(7.2)	(6.8)	6.8	(6.8)	6.8	(6.6)	6.6	6.8	6.6	6.6	(7.0)	6.8	14.28	6.0		20.287
2 NURUL SANDIKA_IN (KALIMANTAN TIMUR)	GOJUSHIHO DAI	(6.8)	(6.6)	(7.4)	7.0	(7.4)	(7.4)	7.0	7.0	(6.8)	(6.8)	7.2	(7.2)	7.2	7.2	14.98	6.36		21.343
3 RENATA GLORY_MADAO_ID (JAWA BARAT)	ANAN DAI	(7.4)	7.4	(7.8)	(7.6)	(7.8)	(7.8)	7.4	(7.2)	7.4	(7.2)	7.4	7.6	(7.2)	7.4	15.54	6.72		22.261
4 JHASTIEN TAUFIQ_ARIYANTI_IS (KEPULAUAN RIAU)	SANSAI	(7.2)	(7.2)	(7.4)	(7.4)	(7.0)	(7.0)	(7.0)	7.0	7.0	(6.8)	7.0	7.0	7.2	7.2	14.84	6.36		21.2 4
5 CHRISTANIA MARIA_RONDO_ID (SULAWESI UTARA)	PAPUREN	(7.6)	(7.6)	7.0	(6.6)	(6.6)	(6.6)	(6.8)	6.8	7.0	(7.0)	(7.2)	7.0	7.0	6.8	14.7	6.18		20.885
6 CHERYL INDIKAGO_BAHARIZKY (GOKASI)	ANAN DAI	(7.2)	7.4	(7.8)	(8.0)	(8.0)	(8.0)	(6.8)	(6.6)	7.2	7.2	7.4	(7.0)	7.2	7.4	15.26	6.6		21.862
7 ARUMINGTYAS KHONI_DAHLIA_SK (JAMBI)	KANKU SHO	(6.4)	(6.4)	6.6	(6.2)	(6.4)	6.4	6.4	6.4	6.6	6.6	(6.8)	(6.8)	(6.8)	(6.8)	13.72	5.82		19.549
8 KAYLA RISKIA_MAHARANI (GOJUKAI)	SUPARINPEI	(6.8)	(6.8)	6.8	(6.4)	(7.2)	(7.2)	6.8	6.6	(6.6)	(6.4)	(7.0)	6.8	7.0	6.8	14.42	6.06		20.486
9 PUTRI AZZURA_M_LK (SUMATERA BARAT B) (*2)	GANKAKU	(6.2)	(6.0)	(6.6)	(6.0)	(6.2)	6.2	6.6	(6.6)	6.6	6.4	6.6	(6.6)	(6.8)	6.4	13.86	5.7		19.568

**R1 G2/2 (8) Tatami 4 10:30(2022-10-03)**

Competitors	Kata	1T	1A	2T	2A	3T	3A	4T	4A	5T	5A	6T	6A	7T	7A	TEC	ATH	Extra	Total Rank
1 MAYA WIJUZANA_IS (RIAU)	GANKAKU	7.0	(6.8)	7.0	(6.8)	(6.8)	(6.8)	(6.8)	6.8	(7.2)	6.8	(7.2)	6.8	6.8	(6.4)	14.56	6.12		20.684
2 NADLIMA LAYLA_IN (DKI JAKARTA)	ANAN DAI	7.4	(7.6)	7.4	(7.2)	7.4	(7.4)	(6.8)	7.4	(7.6)	7.4	(7.8)	(7.6)	(7.2)	7.6	15.54	6.72		22.261
3 SALSABILA RIHHADATUL_AISY_AMRULLAH (KEI SHIN KAN)	PAPUREN	(6.8)	(6.8)	(7.0)	(6.8)	(7.2)	(7.2)	7.0	7.0	(7.2)	7.0	7.0	(7.2)	7.2	7.2	14.84	6.36		21.2 3
4 KANAYA SCARLETTA_POLII (INKANAS)	ANAN DAI	(7.2)	(7.2)	(7.2)	(7.2)	(7.4)	7.2	7.2	7.2	(7.0)	(7.4)	(7.0)	7.2	7.2		15.12	6.48		21.6 2
5 ALIKAMORIN FAIZAH_YURI (INKADO)	ANAN DAI	(6.6)	(6.8)	(7.0)	(7.2)	6.8	(7.0)	(6.6)	7.0	(7.4)	(7.2)	6.8	7.2	6.8	7.0	14.28	6.36		20.645
6 KEINDA ELANEL (BUDOKAI)	SUPARINPEI	6.8	(6.6)	6.8	6.6	(6.4)	(6.4)	(7.4)	(7.2)	(7.0)	6.8	6.6	(6.6)	6.6	6.6	14.28	5.94		20.227
7 MAZAYA FITRIAZKA (BKC)	UNSHU	(6.8)	(6.4)	(6.8)	(6.6)	6.8	6.6	(6.6)	(7.0)	6.8	6.6	6.6	6.6	(6.4)	(6.4)	14.14	5.94		20.088
8 NAJWA WAHYU_INSANI_GS (SUMATERA BARAT A) (*1)	SUPARINPEI	6.8	(6.4)	7.0	(6.8)	6.8	6.6	(7.2)	6.6	(7.4)	(7.2)	(6.4)	6.4	(6.2)	(6.2)	14.42	5.88		20.3 6

**R2-G1 Tatami 3 11:35(2022-10-03)**

Competitors	Kata	1T	1A	2T	2A	3T	3A	4T	4A	5T	5A	6T	6A	7T	7A	TEC	ATH	Extra	Total Rank
1 JHASTIEN TAUFIQ_ARIYANTI_IS (KEPULAUAN RIAU)	PAPUREN	(7.0)	(7.4)	(7.0)	(7.4)	7.2	(7.0)	7.2	(7.2)	7.2	7.4	(7.4)	7.4	(7.4)	7.4	15.12	6.66		21.783
2 CHERYL INDIKAGO_BAHARIZKY (GOKASI)	CHATANYARA KUSHANKU	(6.8)	(7.2)	(7.0)	(7.4)	7.0	(7.2)	7.0	7.2	7.4	7.4	(7.6)	(7.6)	(7.6)	7.4	14.98	6.6		21.584
3 NURUL SANDIKA_IN (KALIMANTAN TIMUR)	SANSAI	(6.8)	(7.0)	(6.8)	(7.0)	7.4	7.2	7.4	(7.4)	7.0	7.2	(7.6)	(7.6)	(7.6)	7.4	15.26	6.54		21.8 2
4 RENATA GLORY_MADAO_ID (JAWA BARAT)	PAPUREN	(7.6)	(7.8)	(7.6)	(7.6)	7.6	(7.4)	(7.8)	7.6	7.6	7.6	(7.8)	(7.8)	7.6	7.6	15.96	6.84		22.8 1

**R2-G2 Tatami 4 11:35(2022-10-03)**

Competitors	Kata	1T	1A	2T	2A	3T	3A	4T	4A	5T	5A	6T	6A	7T	7A	TEC	ATH	Extra	Total Rank
1 MAYA WIJUZANA_IS (RIAU)	PAPUREN	(7.0)	(6.0)	7.0	(6.8)	(7.4)	(7.6)	(7.2)	7.2	(7.4)	(6.8)	7.0	7.0	7.0	7.0	14.84	6.36		21.2 4
2 SALSABILA RIHHADATUL_AISY_AMRULLAH (KEI SHIN KAN)	SUPARINPEI	(7.0)	(7.4)	7.2	(7.0)	(7.6)	(7.4)	(7.4)	7.4	7.4	7.4	7.0	(7.0)	(6.8)	7.2	15.12	6.6		21.721
3 NADLIMA LAYLA_IN (DKI JAKARTA)	CHIBANA NO KUSHANKU	(8.0)		7.0	(7.0)	(7.8)	(7.4)	7.2	(7.6)	7.4	7.2	(6.8)	7.0	(6.6)	7.2	15.12	6.42		21.542
4 KANAYA SCARLETTA_POLII (INKANAS)	PAPUREN	(8.0)	(6.4)	7.2	(7.0)	(7.6)	(7.6)	7.2	(7.4)	(7.0)	7.4	7.0	7.2	(6.8)	7.0	14.98	6.48		21.463

**R3 Bronze Medal Match 1 Tatami 3 12:05(2022-10-03)**

Competitors	Kata	1T	1A	2T	2A	3T	3A	4T	4A	5T	5A	6T	6A	7T	7A	TEC	ATH	Extra	Total Rank
1 NURUL SANDIKA_IN (KALIMANTAN TIMUR)	GANKAKU	(7.0)	(7.2)	(7.6)	(7.6)	(7.0)	(7.2)	(7.2)	(7.4)	7.2	7.2	7.0	7.2	7.0	7.2	14.84	6.48		21.322
2 KANAYA SCARLETTA_POLII (INKANAS)	CHIBANA NO KUSHANKU	(7.0)	(7.0)	(7.4)	(7.6)	7.2	(7.6)	(7.4)	(7.2)	7.4	7.4	7.2	7.2	(7.0)	7.4	15.26	6.6		21.861

**R3 Bronze Medal Match 2 Tatami 4 12:05(2022-10-03)**

Competitors	Kata	1T	1A	2T	2A	3T	3A	4T	4A	5T	5A	6T	6A	7T	7A	TEC	ATH	Extra	Total Rank
1 JHASTIEN TAUFIQ_ARIYANTI_IS (KEPULAUAN RIAU)	CHATANYARA KUSHANKU	(7.6)	(7.8)	(7.6)	(7.4)	(7.0)	(7.2)	7.2	7.2	(7.0)	7.4	7.0	7.2	7.2	(7.0)	14.98	6.54		21.522
2 NADLIMA LAYLA_IN (DKI JAKARTA)	OHAN	(7.8)	(8.0)	(7.8)	7.6	(7.4)	(7.4)	7.6	7.4	(7.4)	(7.8)	7.4	7.4	7.4	(7.2)	15.68	6.72		22.4 1

**R3 Gold Medal Match Tatami 1 13:55(2022-10-03)**

Competitors	Kata	1T	1A	2T	2A	3T	3A	4T	4A	5T	5A	6T	6A	7T	7A	TEC	ATH	Extra	Total Rank
1 RENATA GLORY_MADAO_ID (JAWA BARAT)	ANAN	(7.4)	7.6	7.6	(7.4)	(8.0)	(8.0)	7.4	7.6	(7.8)	(7.8)	7.4	(7.2)	(7.2)	7.4	15.68	6.78		22.461
2 SALSABILA RIHHADATUL_AISY_AMRULLAH (KEI SHIN KAN)	ANAN DAI	(7.4)	7.2	7.4	7.2	(7.6)	(7.8)	7.4	(7.4)	7.4	7.4	(7.2)	(7.0)	(7.0)	(6.8)	15.54	6.54		22.082

**KEJUARAAN NASIONAL KARATE PIALA KETUA  
UMUM PB FORKI TAHUN 2022 - 2022-10-03  
KADET KATA PERORANGAN PUTRI**

**Results**

1	RENATA GLORY MADA0 ID	JAWA BARAT		INDONESIA
2	SALSABILA RIHHADATUL AISY AMRULLAH	KEI SHIN KAN		INDONESIA
3	KANAYA SCARLETTA POLII	INKANAS		INDONESIA
3	NADLIMA LAYLA IN	DKI JAKARTA		INDONESIA
5	NURUL SANDIKA IN	KALIMANTAN TIMUR		INDONESIA
5	JHASTIEN TAUFIQ ARIYANTI IS	KEPULAUAN RIAU		INDONESIA
7	CHERYL INDIKAGO BAHARIZKY	GOKASI		INDONESIA
7	MAYA WIJUZANA IS	RIAU		INDONESIA





# JUNIOR KUMITE PUTRA +76 KG

KEJUARAAN NASIONAL KARATE PIALA KETUA UMUM PB FORKI TAHUN 2022, INA

2022-10-04

Tatami  
4 17:45

Pool  
2/2

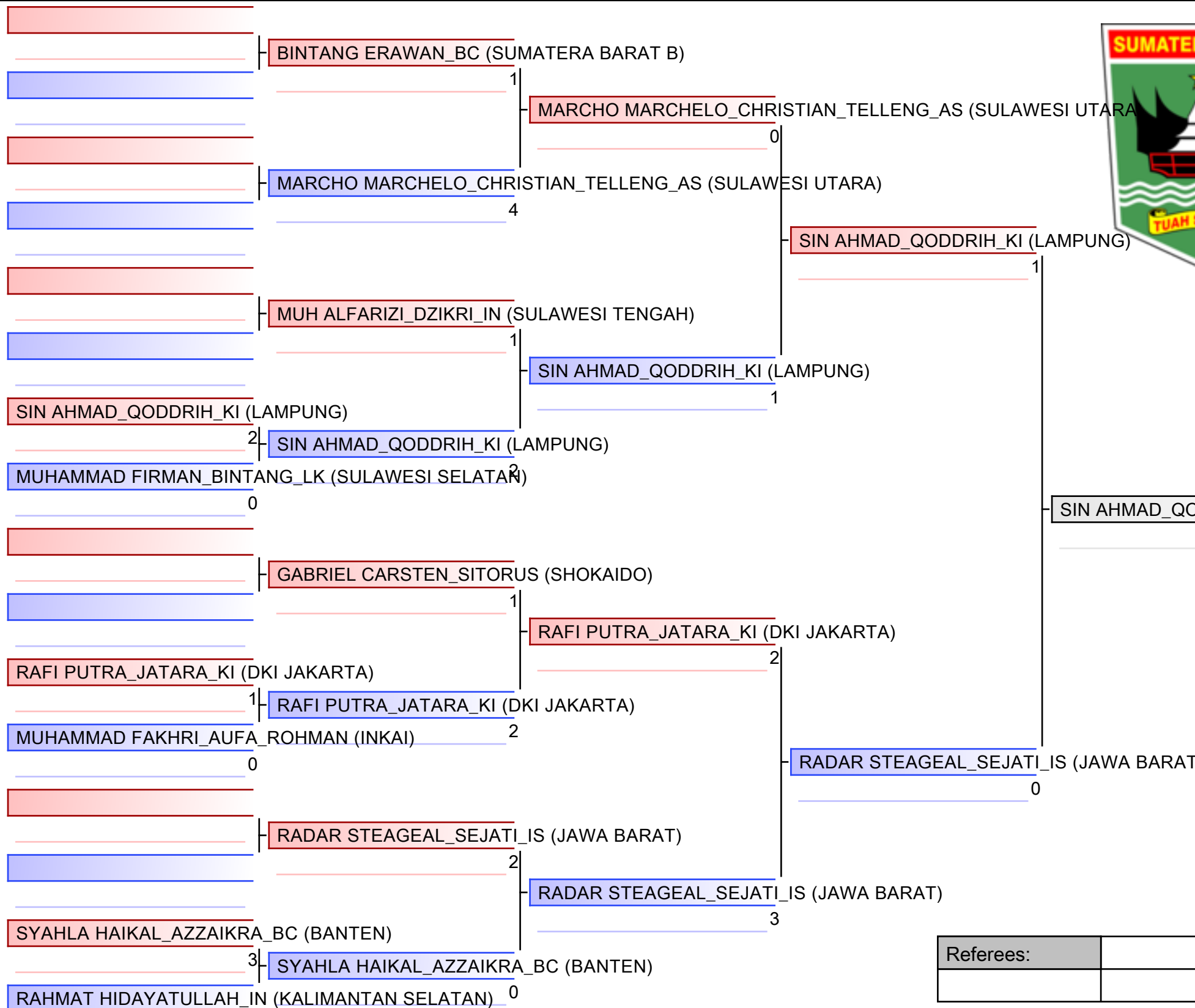

- |  |
|--|
| 1. I GEDE_ARYA_PUJA_ADNYANA (KKI)                        |
| 2. SIN AHMAD_QODDRIH_KI (LAMPUNG)                        |
| 3. RADAR STEAGEAL_SEJATI_IS (JAWA BARAT)                 |
| 3. MADE ANDIKA_PRAMANA_PUTRA_KI (BALI)                   |
| 5. MARCHO MARCHELO_CHRISTIAN_TELLENG_AS (SULAWESI UTARA) |
| 5. RAMAKRISHNA YOGANANDA (INKADO)                        |
| 7. MUH ALFARIZI_DZIKRI_IN (SULAWESI TENGAH)              |
| 7. PABRAMROE PASAISTRA_AS (DIY)                          |

Referees:			

# JUNIOR KUMITE PUTRA -55 KG

KEJUARAAN NASIONAL KARATE PIALA KETUA UMUM PB FORKI TAHUN 2022, INA

2022-10-04

Tatami  
1 18:00

Pool  
1/2

RAMA ARDIAN\_ID (SUMATERA BARAT B)

1 | ALDINO HEZKYA\_DOLOKSARIBUK (KEI SHIN KAN)

ALDINO HEZKYA\_DOLOKSARIBUK (KEI SHIN KAN)

5

DENISH RIZKITANANDO\_L\_BC (LAMPUNG)

0

M HAFIDZ\_ALZAVARAN (SHOKAIDO)

M HAFIDZ\_ALZAVARAN (SHOKAIDO)

4

JOSEPH MARIANNO\_RATHZINGER\_IN (DKI JAKARTA)

2

JOSEPH MARIANNO\_RATHZINGER\_IN (DKI JAKARTA)

DISMA SANG\_W\_IN (KALIMANTAN TIMUR)

1

ALDI BARAGI (PORBIKAWA)

0

ILHAM ZACKY\_SAPUTRA\_IS (RIAU)

ILHAM ZACKY\_SAPUTRA\_IS (RIAU)

0

RICHARD EDWARD\_JONES\_MANOPO\_WK (GORONTALO)

1

MARIO CHANDRA (SHINDOKA)

MARIO CHANDRA (SHINDOKA)

6

M AMRI\_ALFAJRIHAN (INKADO)

4

M AMRI\_ALFAJRIHAN (INKADO)

A\_A A\_ALIT\_PUTRA\_DARMA\_YOGA\_KI (BALI)

0

NAUFAL RIZKY\_FADHILAH\_IS (KEPULAUAN RIAU)

4

NAUFAL RIZKY\_FADHILAH\_IS (KEPULAUAN RIAU)

RIFQI ANDRIANSYAH\_PUTRA (FUNAKOSHI)

0

MUHAMMAD IMAM\_KI (ACEH)

6

MUHAMMAD IMAM\_KI (ACEH)

M RADITYA\_AZHARI\_LK (KALIMANTAN SELATAN)

1

(c)sportdata GmbH & Co KG 2000-2022 (2022-10-04 22:26) v 9.9.0 build 1 (2022-08-12) License: PB FORKI INA (expire 2023-07-04)



M HAFIDZ\_ALZAVARAN (SHOKAIDO)

0

JOSEPH MARIANNO\_RATHZINGER\_IN (DKI JAKARTA)

2

JOSEPH MARIANNO\_RATHZINGER\_IN (DKI JAKARTA)

1

JOSEPH MARIANNO\_RATHZINGER\_IN (DKI JAKARTA)

M AMRI\_ALFAJRIHAN (INKADO)

1

MUHAMMAD IMAM\_KI (ACEH)

0

MUHAMMAD IMAM\_KI (ACEH)

5

- |  |
|--|
| 1. JOSEPH MARIANNO_RATHZINGER_IN (DKI JAKARTA) |
| 2. DAFFA FAALIH_ANANTA (ASKI)                  |
| 3. YOHANES MUHAMAD_RAMDAN_KI (JAWA BARAT)      |
| 3. MUHAMMAD IMAM_KI (ACEH)                     |
| 5. ANDHIKA MICHOLA_IS (SUMATERA BARAT A)       |
| 5. M HAFIDZ_ALZAVARAN (SHOKAIDO)               |
| 7. HUMAN IRSYAD_SABIL (GOJUKAI)                |
| 7. DISMA SANG_W_IN (KALIMANTAN TIMUR)          |

Referees:			

# JUNIOR KUMITE PUTRA -55 KG

KEJUARAAN NASIONAL KARATE PIALA KETUA UMUM PB FORKI TAHUN 2022, INA

2022-10-04

Tatami  
2 18:00

Pool  
2/2

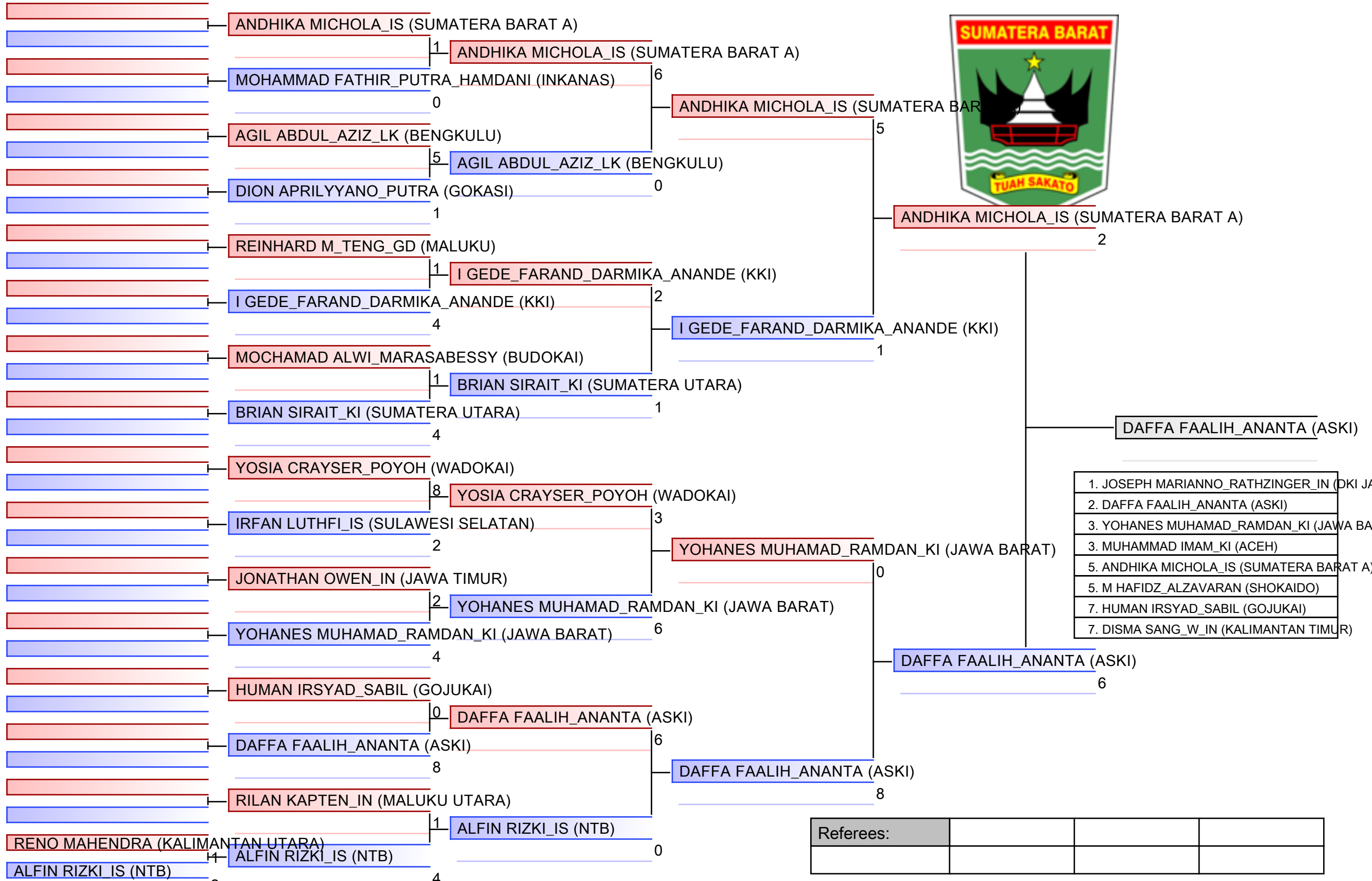

1. JOSEPH MARIANNO\_RATHZINGER\_IN (DKI JAWA BARAT)
2. DAFFA FAALIH\_ANANTA (ASKI)
3. YOHANES MUHAMAD\_RAMDAN\_KI (JAWA BARAT)
3. MUHAMMAD IMAM\_KI (ACEH)
5. ANDHIKA MICHOLA\_IS (SUMATERA BARAT A)
5. M HAFIDZ\_ALZAVARAN (SHOKAIDO)
7. HUMAN IRSYAD\_SABIL (GOJUKAI)
7. DISMA SANG\_W\_IN (KALIMANTAN TIMUR)





# JUNIOR KUMITE PUTRA -61 KG

KEJUARAAN NASIONAL KARATE PIALA KETUA UMUM PB FORKI TAHUN 2022, INA

2022-10-04

Tatami  
3 16:05

Pool  
2/2

RAVIL PUTRA\_N\_IS (SUMATERA BARAT B)

0 | MUHAMMAD ACHUL\_ALFANI\_IN (BANTEN)

MUHAMMAD ACHUL\_ALFANI\_IN (BANTEN) 4

3 | MUHAMMAD ACHUL\_ALFANI\_IN (BANTEN)

AVRY ANGGORO\_NASUTION\_KI (ACEH) 1

2 | MUHAMMAD SOFYAN (GOJUKAI)

MUHAMMAD SOFYAN (GOJUKAI) 3

5 | AHMAD ALAYDRUS\_IN (JAWA TIMUR)

AHMAD ALAYDRUS\_IN (JAWA TIMUR) 0

8 | AHMAD ALAYDRUS\_IN (JAWA TIMUR)

ANDRY FIRMANSYAH\_IS (KALIMANTAN TIMUR) 1

0 | AHMAD ALAYDRUS\_IN (JAWA TIMUR)

MUHAMMAD FADHIL\_GIYO\_SAPUTRO (INKANAS) 1

3 | MUHAMMAD FADHIL\_GIYO\_SAPUTRO (INKANAS)

ADRIAN WICAKSONO\_PRABOWO\_IS (JAWA BARAT) 1

2 |

SOFYAN HAFIFI\_IS (NTB) 0

0 | KOMANG SASTRAWAN\_LK (BALI)

KOMANG SASTRAWAN\_LK (BALI) 8

DAMAR ARIF\_SETIYANTO\_IN (DIY) 3

3 | KOMANG SASTRAWAN\_LK (BALI)

AJI IS (SUMATERA UTARA) 0

6 | KOMANG SASTRAWAN\_LK (BALI)

M FIKRI\_ALFARIZI\_BATUBARA (SHIROITE) 7

7 | M FIKRI\_ALFARIZI\_BATUBARA (SHIROITE)

HABIB QOIBU\_SALIM\_IS (BENGKULU) 0

2 | MUHAMMAD YAHYA\_GHIFARI (SHINDOKA)

MUHAMMAD YAHYA\_GHIFARI (SHINDOKA) 3

3 | MUHAMMAD YAHYA\_GHIFARI (SHINDOKA)

AHMAD HAMZAH\_GK (SULAWESI SELATAN) 8

1 |



KOMANG SASTRAWAN\_LK (BALI)

1. KOMANG SASTRAWAN_LK (BALI)
2. LINGGA KURNIAWAN (ASKI)
3. L MUHAMMAD_AZWIN (INKAI)
3. AHMAD ALAYDRUS_IN (JAWA TIMUR)
5. ABIZAR IS (SUMATERA SELATAN)
5. MUHAMMAD YAHYA_GHIFARI (SHINDOKA)
7. KADEK PRINCE_SADWIKI_SHANDY (KKI)
7. AJI IS (SUMATERA UTARA)

Referees:			

# JUNIOR KUMITE PUTRA -68 KG

KEJUARAAN NASIONAL KARATE PIALA KETUA UMUM PB FORKI TAHUN 2022, INA

2022-10-04

Tatami  
1 15:20

Pool  
1/2

RAJO BINTANG\_IS (SUMATERA BARAT A)

3 | RAJO BINTANG\_IS (SUMATERA BARAT A)

YOHANNES CHRISTIAN\_TARIHORAN\_KI (RIAU)

3 | RAJO BINTANG\_IS (SUMATERA BARAT A)

PANDU VISA\_IN (SULAWESI SELATAN)

0 | FITO SAPUTRA (GOKASI)

FITO SAPUTRA (GOKASI)

1 | AKBAR TYO\_PAMUNGKAS (ASKI)

PUTU AGUS\_SASTRA\_INDRAWAN\_IN (BALI)

2 | AKBAR TYO\_PAMUNGKAS (ASKI)

AKBAR TYO\_PAMUNGKAS (ASKI)

2 | AKBAR TYO\_PAMUNGKAS (ASKI)

ADE FIRMAN\_GHANI (SHOTO-KAI)

0 | DAIVA MAHADANA\_IS (DKI JAKARTA)

DAIVA MAHADANA\_IS (DKI JAKARTA)

3 | AKBAR TYO\_PAMUNGKAS (ASKI)

GILANG PERMANA\_AJIE\_IN (BANTEN)

5 | RAID DARIS\_MUSAQQI (INKANAS)

RAID DARIS\_MUSAQQI (INKANAS)

7 | SULTAN ROBBI\_MUTTAQIN\_BC (JAWA BARAT)

MUHAMMAD FARID\_KI (ACEH)

3 | SULTAN ROBBI\_MUTTAQIN\_BC (JAWA BARAT)

SULTAN ROBBI\_MUTTAQIN\_BC (JAWA BARAT)

6 | AHMAD WAHIDIN\_SAPUTRA\_IN (JAMBI)

JOSHUA LORES\_P\_LUMBANTORUAN (SHOKAIDO)

2 | AHMED RIFQI\_MAUANA\_IN (SUMATERA SELATAN)

AHMED RIFQI\_MAUANA\_IN (SUMATERA SELATAN)

5 | AHMAD WAHIDIN\_SAPUTRA\_IN (JAMBI)

SENDI IN (NTB)

1 | AHMAD WAHIDIN\_SAPUTRA\_IN (JAMBI)

AHMAD WAHIDIN\_SAPUTRA\_IN (JAMBI)

2 | AHMAD WAHIDIN\_SAPUTRA\_IN (JAMBI)



AKBAR TYO\_PAMUNGKAS (ASKI)

- |  |
|--|
| 1. AKBAR TYO_PAMUNGKAS (ASKI)            |
| 2. BAMBANG PRIYAMBODO (INKAI)            |
| 3. FIRMAN GENTURIN (JAWA TIMUR)          |
| 3. DAIVA MAHADANA_IS (DKI JAKARTA)       |
| 5. ANDIKA HULIO_PRATAMA_BECKHAM_KI (LAM) |
| 5. AHMAD WAHIDIN_SAPUTRA_IN (JAMBI)      |
| 7. MICHAEL CHARIS_SHEVCHENKO_KARWUR (IN) |
| 7. RAJO BINTANG_IS (SUMATERA BARAT A)    |

Referees:			

# JUNIOR KUMITE PUTRA -68 KG

KEJUARAAN NASIONAL KARATE PIALA KETUA UMUM PB FORKI TAHUN 2022, INA

2022-10-04

Tatami  
2 15:20

Pool  
2/2

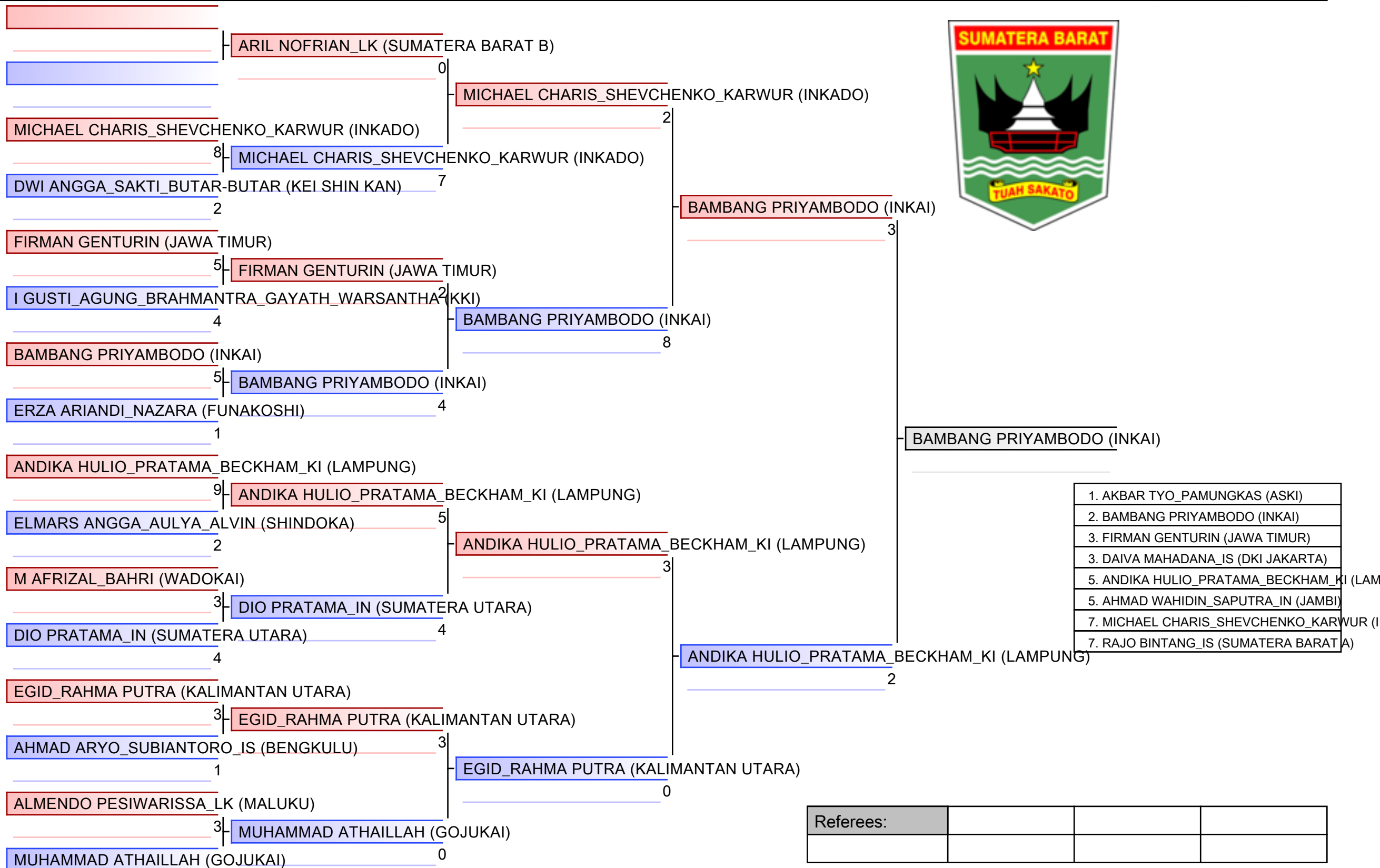

- |  |
|--|
| 1. AKBAR TYO_PAMUNGKAS (ASKI)                |
| 2. BAMBANG PRIYAMBODO (INKAI)                |
| 3. FIRMAN GENTURIN (JAWA TIMUR)              |
| 3. DAIVA MAHADANA_IS (DKI JAKARTA)           |
| 5. ANDIKA HULIO_PRATAMA_BECKHAM_KI (LAMPUNG) |
| 5. AHMAD WAHIDIN_SAPUTRA_IN (JAMBI)          |
| 7. MICHAEL CHARIS_SHEVCHENKO_KARWUR (INKADO) |
| 7. RAJO BINTANG_IS (SUMATERA BARAT A)        |

Referees:			



# JUNIOR KUMITE PUTRA -76 KG

KEJUARAAN NASIONAL KARATE PIALA KETUA UMUM PB FORKI TAHUN 2022, INA

2022-10-04

Tatami  
3 15:05

Pool  
1/2

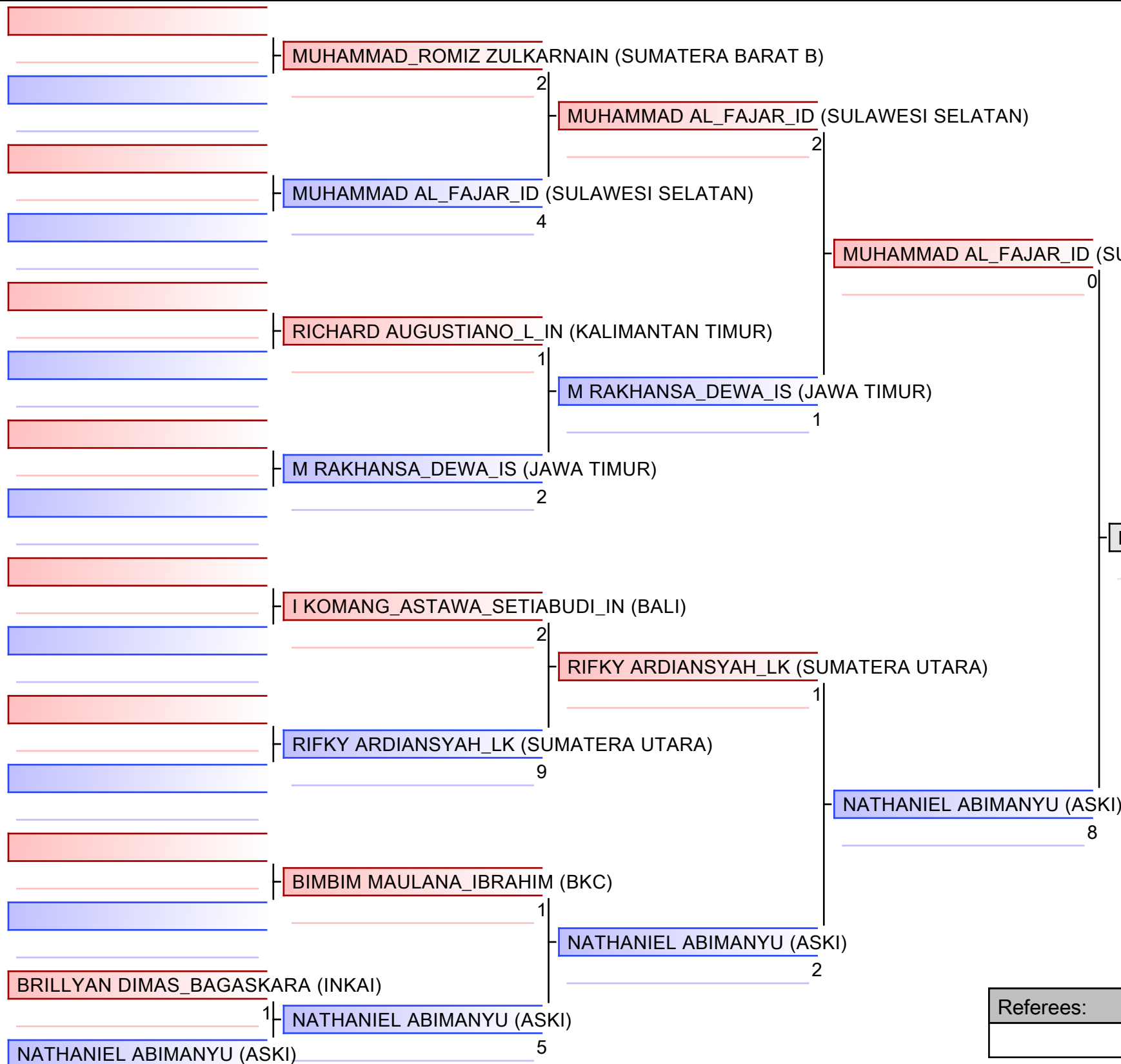

NATHANIEL ABIMANYU (ASKI)

- |  |
|--|
| 1. NATHANIEL ABIMANYU (ASKI)               |
| 2. FX ALVONSSE_WIDYANSYAH (SHOTO-KAI)      |
| 3. MUHAMMAD YUSUF_SYHADAN (INKADO)         |
| 3. BRILLYAN DIMAS_BAGASKARA (INKAI)        |
| 5. MUHAMMAD FIKRI (INKANAS)                |
| 5. MUHAMMAD AL_FAJAR_ID (SULAWESI SELATAN) |
| 7. MUHAMMAD RIDHO_PURWADI (FUNAKOSHI)      |
| 7. RIFKY ARDIANSYAH_LK (SUMATERA UTARA)    |

Referees:			

# JUNIOR KUMITE PUTRA -76 KG

KEJUARAAN NASIONAL KARATE PIALA KETUA UMUM PB FORKI TAHUN 2022, INA

2022-10-04

Tatami  
4 15:05

Pool  
2/2

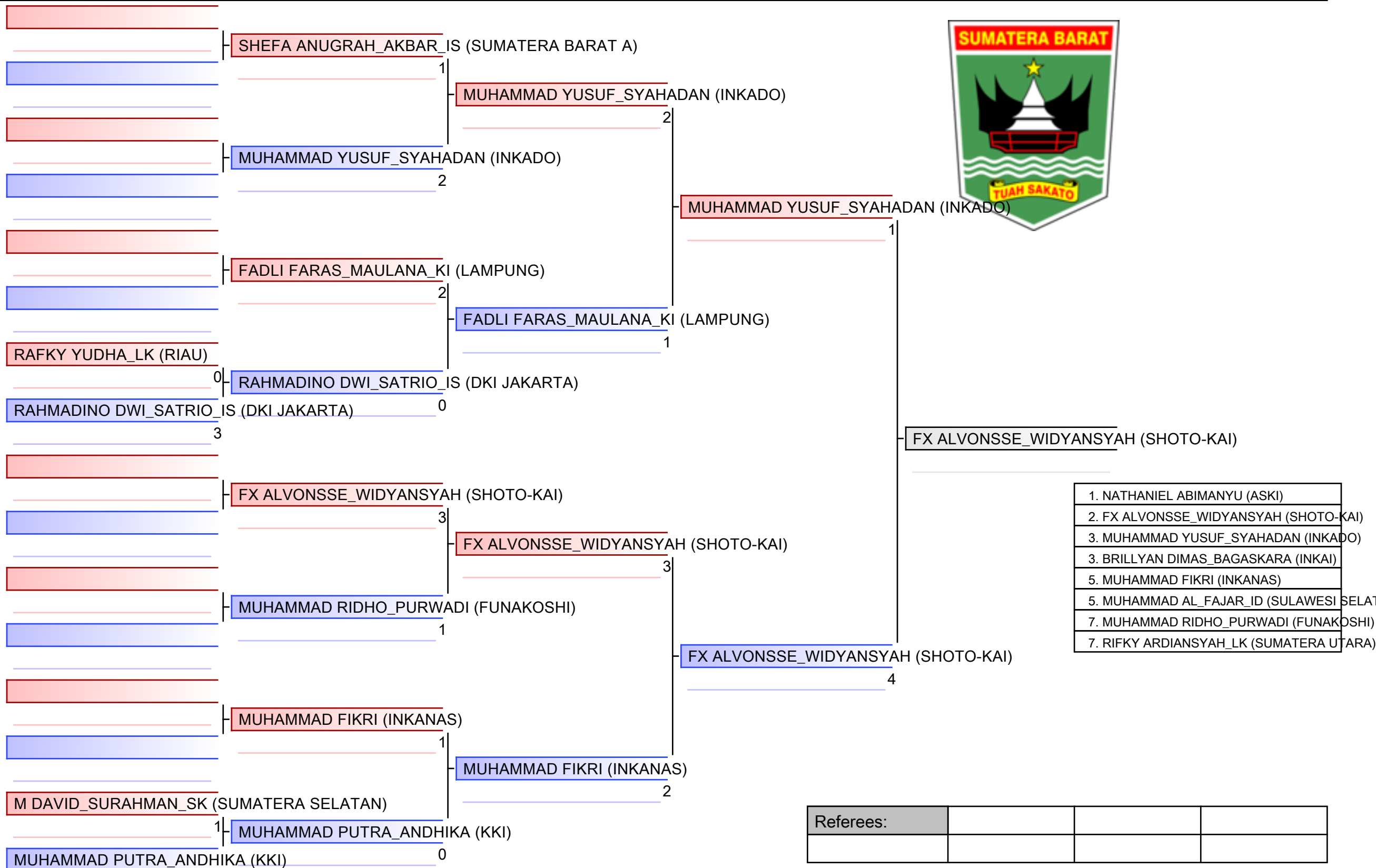

- |  |
|--|
| 1. NATHANIEL ABIMANYU (ASKI)               |
| 2. FX ALVONSSE_WIDYANSYAH (SHOTO-KAI)      |
| 3. MUHAMMAD YUSUF_SYHADAN (INKADO)         |
| 3. BRILLYAN DIMAS_BAGASKARA (INKAI)        |
| 5. MUHAMMAD FIKRI (INKANAS)                |
| 5. MUHAMMAD AL_FAJAR_ID (SULAWESI SELATAN) |
| 7. MUHAMMAD RIDHO_PURWADI (FUNAKOSHI)      |
| 7. RIFKY ARDIANSYAH_LK (SUMATERA UTARA)    |

Referees:			

# JUNIOR KUMITE PUTRI +59 KG

KEJUARAAN NASIONAL KARATE PIALA KETUA UMUM PB FORKI TAHUN 2022, INA

2022-10-04

Tatami  
4 12:45

Pool  
1/2

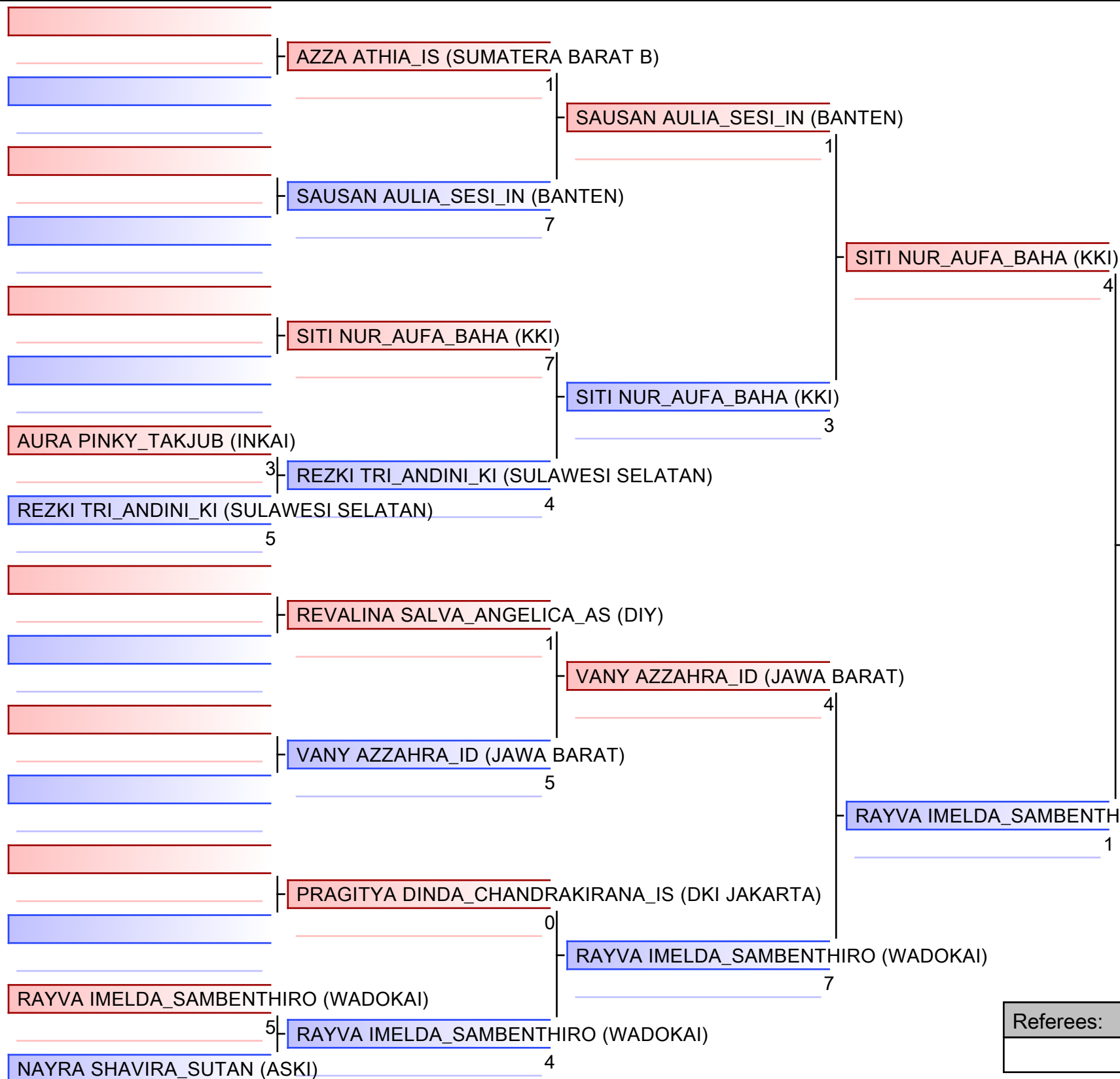

SITI NUR\_AUFA\_BAHA (KKI)

- |   |
|---|
| 1. ALMAHYRA TIARA_SANDI (INKANAS)         |
| 2. SITI NUR_AUFA_BAHA (KKI)               |
| 3. SAUSAN AULIA_SESI_IN (BANTEN)          |
| 3. MEIVIONA ZUHRINA_WK (SUMATERA UTARA)   |
| 5. RAYVA IMELDA_SAMBENTHIRO (WADOKAI)     |
| 5. ABYGAIL THERESA_SENDOW (INKADO)        |
| 7. REZKI TRI_ANDINI_KI (SULAWESI SELATAN) |
| 7. GITA DAMAYANTI_IS (JAWA TIMUR)         |

Referees:			

# JUNIOR KUMITE PUTRI +59 KG

KEJUARAAN NASIONAL KARATE PIALA KETUA UMUM PB FORKI TAHUN 2022, INA

2022-10-04

Tatami  
3 13:00

Pool  
2/2

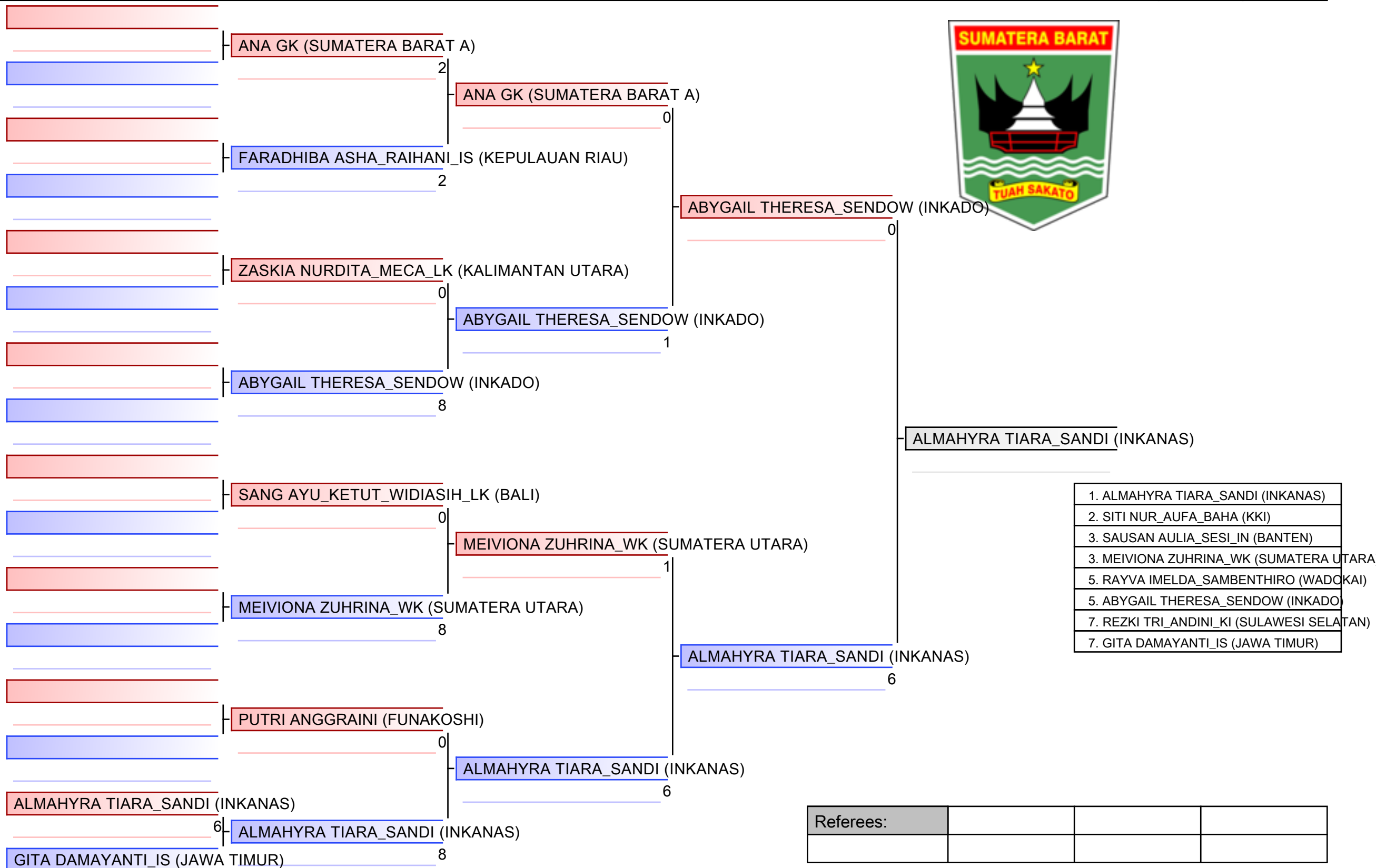

- |   |
|---|
| 1. ALMAHYRA TIARA_SANDI (INKANAS)         |
| 2. SITI NUR_AUFA_BAHA (KKI)               |
| 3. SAUSAN AULIA_SESI_IN (BANTEN)          |
| 3. MEIVIONA ZUHRINA_WK (SUMATERA UTARA)   |
| 5. RAYVA IMELDA_SAMBENTHIRO (WADOKAI)     |
| 5. ABYGAIL THERESA_SENDOW (INKADO)        |
| 7. REZKI TRI_ANDINI_KI (SULAWESI SELATAN) |
| 7. GITA DAMAYANTI_IS (JAWA TIMUR)         |

Referees:			

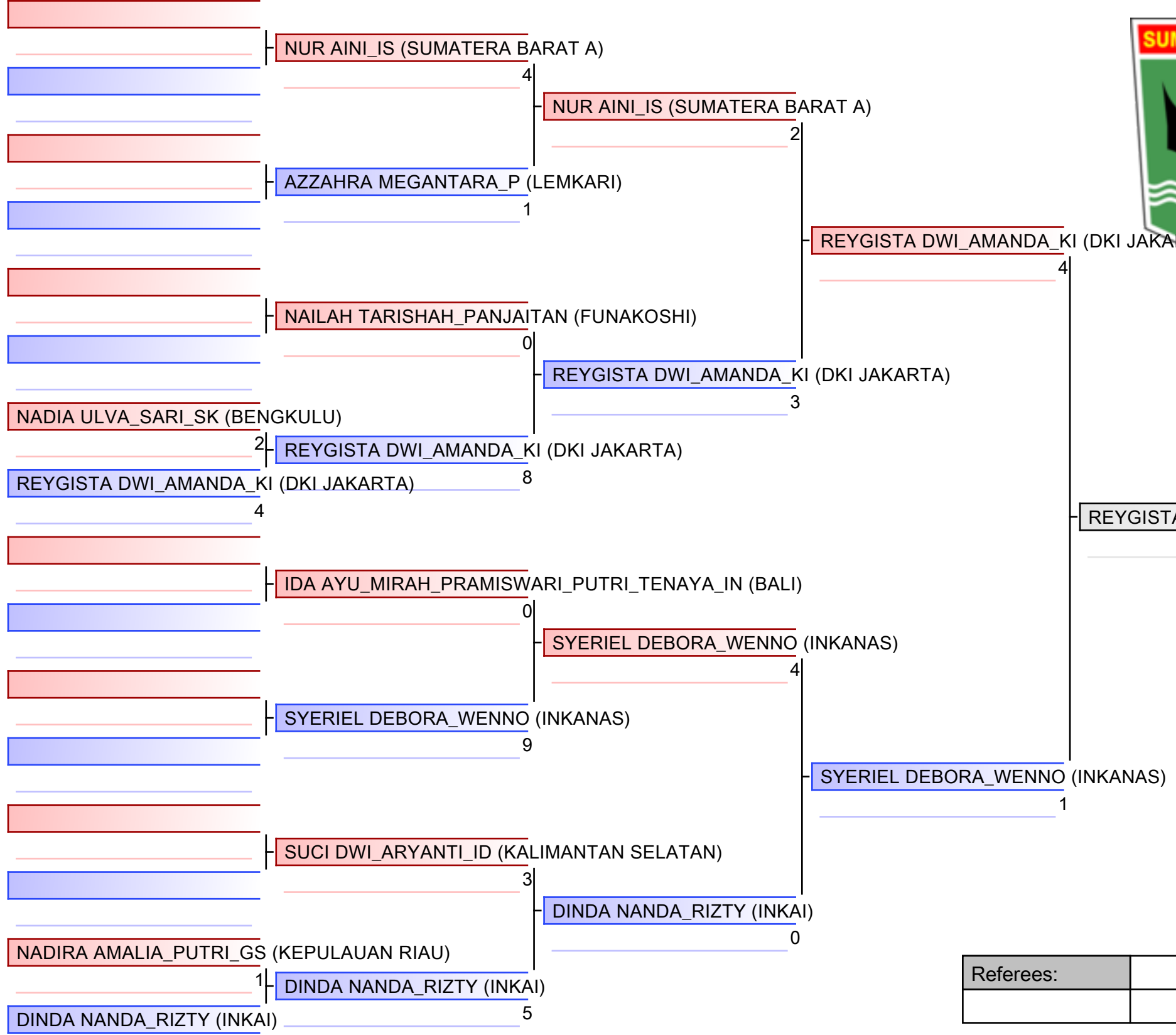

- |   |
|---|
| 1. REYGISTA DWI_AMANDA_KI (DKI JAKARTA)   |
| 2. MULIA JISCHA_CHERRYL_S_IS (JAWA TIMUR) |
| 3. ALYA DEANTI_SUTENDI_IN (JAWA BARAT)    |
| 3. SYERIEL DEBORA_WENNO (INKANAS)         |
| 5. FITRISYA HENDITA_LK (SUMATERA BARAT B) |
| 5. NUR AINI_IS (SUMATERA BARAT A)         |
| 7. VINA ANUGERAH_A_IS (KALIMANTAN TIMUR)  |
| 7. NADIA ULVA_SARI_SK (BENGKULU)          |

Referees:			

# JUNIOR KUMITE PUTRI -48 KG

KEJUARAAN NASIONAL KARATE PIALA KETUA UMUM PB FORKI TAHUN 2022, INA

2022-10-04

Tatami  
4 14:00

Pool  
2/2

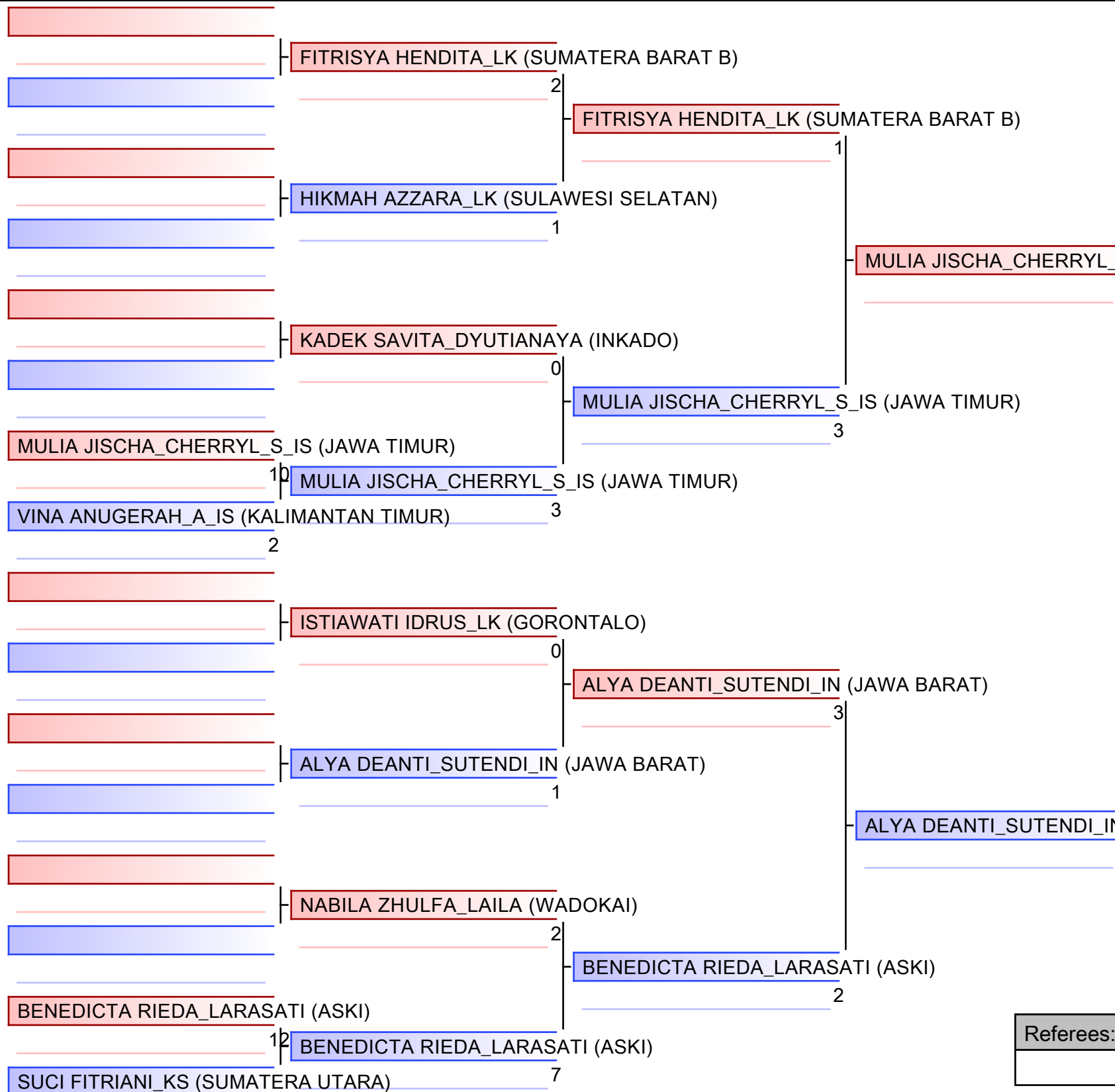

- |   |
|---|
| 1. REYGISTA DWI_AMANDA_KI (DKI JAKARTA)   |
| 2. MULIA JISCHA_CHERRYL_S_IS (JAWA TIMUR) |
| 3. ALYA DEANTI_SUTENDI_IN (JAWA BARAT)    |
| 3. SYERIEL DEBORA_WENNO (INKANAS)         |
| 5. FITRISYA HENDITA_LK (SUMATERA BARAT B) |
| 5. NUR AINI_IS (SUMATERA BARAT A)         |
| 7. VINA ANUGERAH_A_IS (KALIMANTAN TIMUR)  |
| 7. NADIA ULVA_SARI_SK (BENGKULU)          |

Referees:			

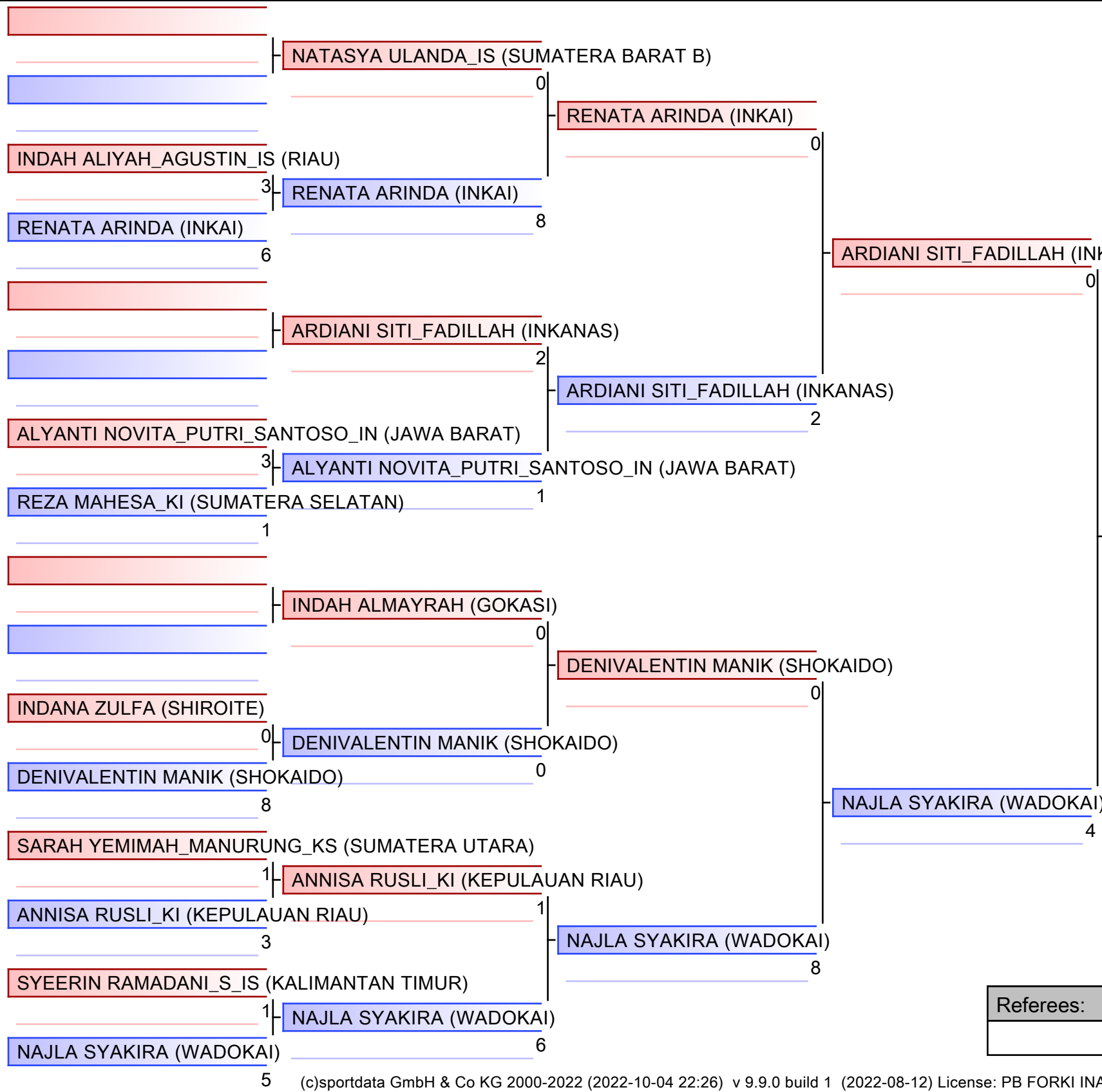

NAJLA SYAKIRA (WADOKAI)

- |   |
|---|
| 1. NAJLA SYAKIRA (WADOKAI)                  |
| 2. LOVIA GINDHA_PUSPITA_IS (DKI JAKARTA)    |
| 3. LUVENA MILANO_SETIYAKA_IN (JAWA TENGAH)  |
| 3. SYEERIN RAMADANI_S_IS (KALIMANTAN TIMUR) |
| 5. ARMY DEWI_PURNAMASARI_IN (BALI)          |
| 5. ARDIANI SITI_FADILLAH (INKANAS)          |
| 7. CITRA ANISA_EDWARD_LK (SUMATERA BARAT)   |
| 7. DENIVALENTIN MANIK (SHOKAIDO)            |

Referees:			



# JUNIOR KUMITE PUTRI -53 KG

KEJUARAAN NASIONAL KARATE PIALA KETUA UMUM PB FORKI TAHUN 2022, INA

2022-10-04

Tatami  
2 16:50

Pool  
2/2

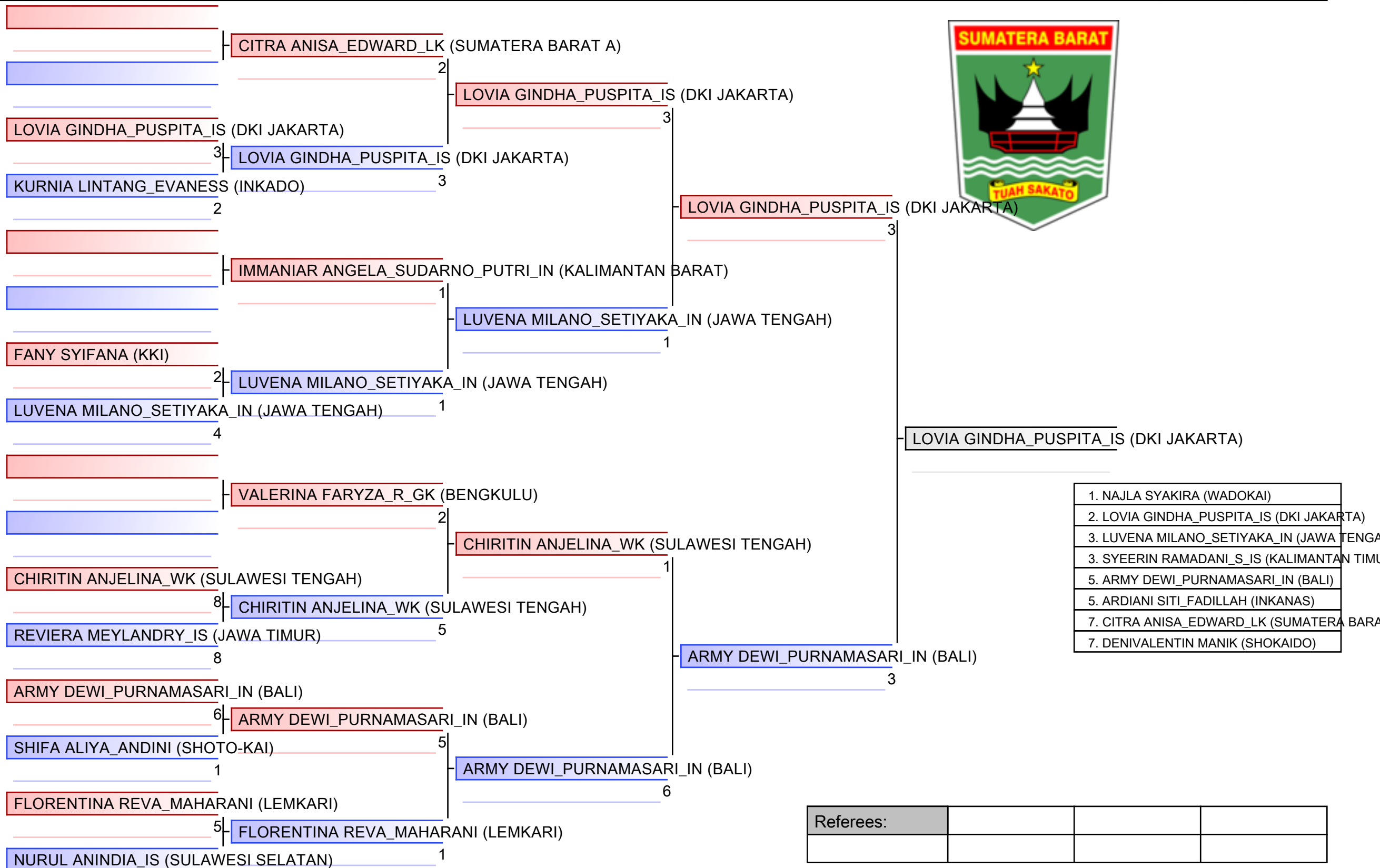

- |   |
|---|
| 1. NAJLA SYAKIRA (WADOKAI)                  |
| 2. LOVIA GINDHA_PUSPITA_IS (DKI JAKARTA)    |
| 3. LUVENA MILANO_SETIYAKA_IN (JAWA TENGAH)  |
| 3. SYEERIN RAMADANI_S_IS (KALIMANTAN TIMUR) |
| 5. ARMY DEWI_PURNAMASARI_IN (BALI)          |
| 5. ARDIANI SITI_FADILLAH (INKANAS)          |
| 7. CITRA ANISA_EDWARD_LK (SUMATERA BARAT)   |
| 7. DENIVALENTIN MANIK (SHOKAIDO)            |

Referees:			



# JUNIOR KUMITE PUTRI -59 KG

KEJUARAAN NASIONAL KARATE PIALA KETUA UMUM PB FORKI TAHUN 2022, INA

2022-10-04

Tatami  
2 13:50

Pool  
1/2

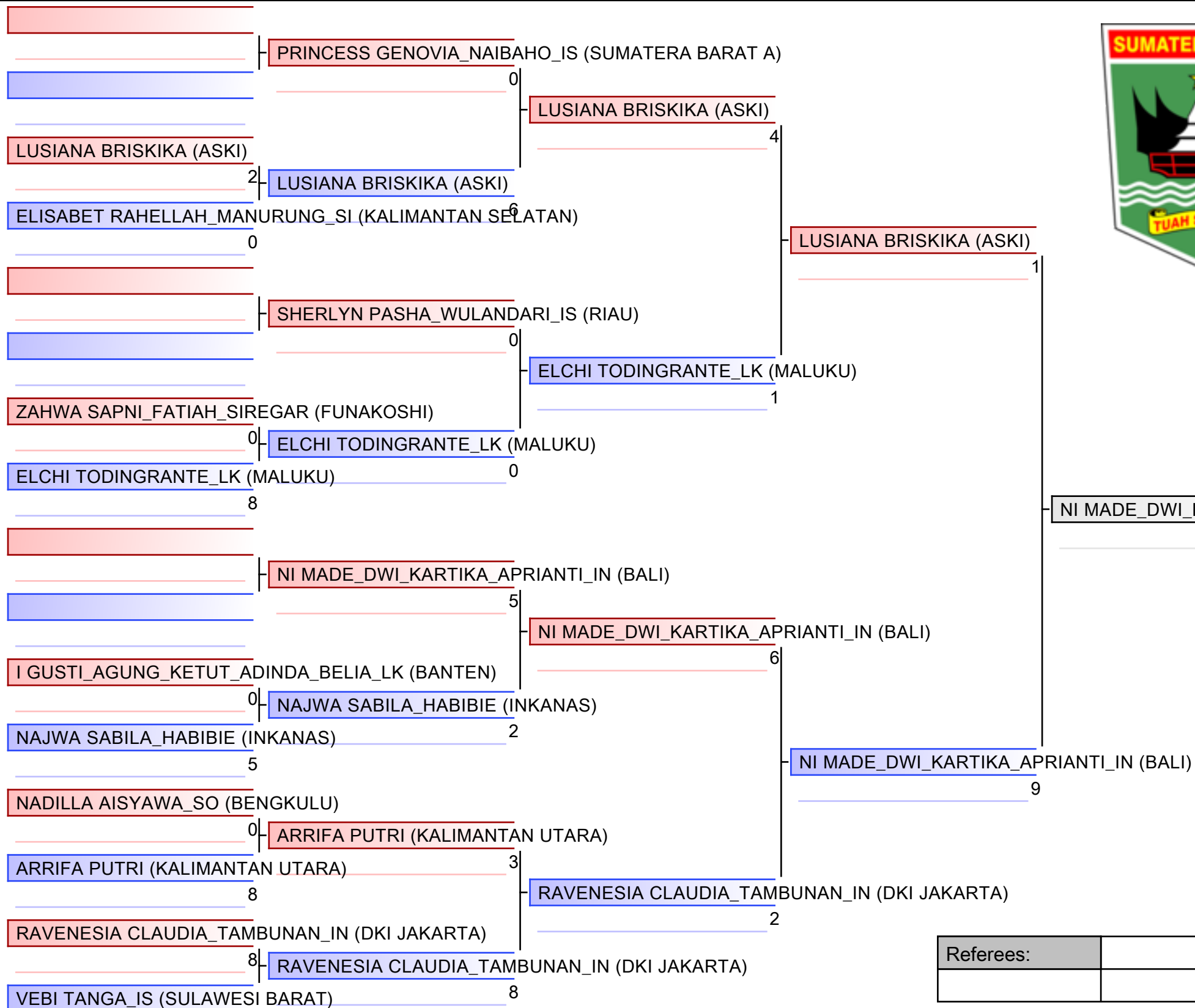

NI MADE\_DWI\_KARTIKA\_APRIANTI\_IN (BALI)

- |   |
|---|
| 1. ADELIA INDAH_PERMATA_SARI_TUASIKAL (IN |
| 2. NI MADE_DWI_KARTIKA_APRIANTI_IN (BALI) |
| 3. NAJWA SABILA_HABIBIE (INKANAS)         |
| 3. LISYE KASIH_SATIAMU_AS (SULAWESI UTARA |
| 5. LUSIANA BRISIKKA (ASKI)                |
| 5. SALMA AULIA (INKAI)                    |
| 7. RAVENESIA CLAUDIA_TAMBUNAN_IN (DKI JAK |
| 7. FITRIA MAGITA_NOVA_BC (JAWA BARAT)     |

Referees:			

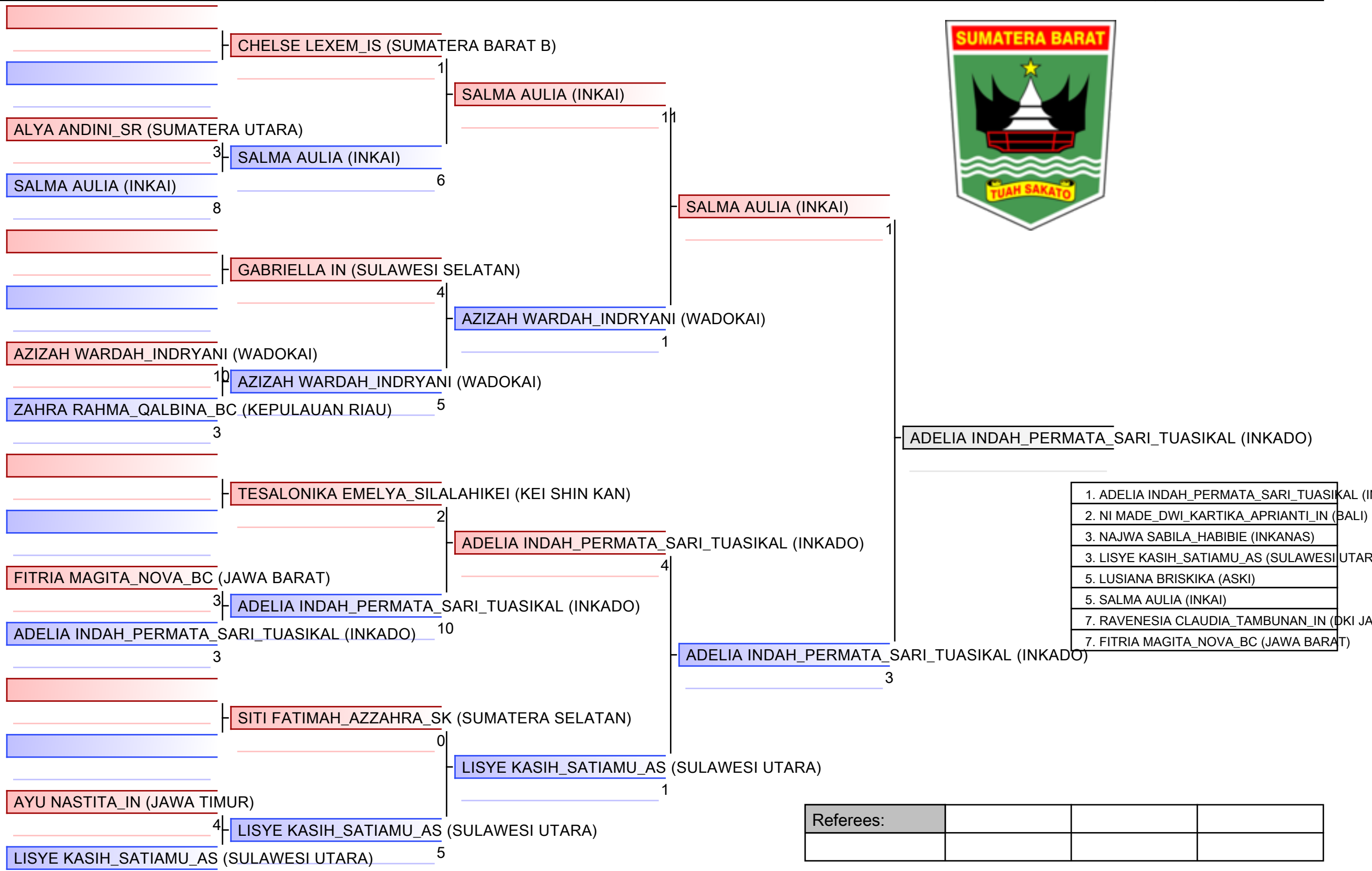

- |  |
|--|
| 1. ADELIA INDAH_PERMATA_SARI_TUASIKAL (INKADO) |
| 2. NI MADE_DWI_KARTIKA_APRIANTI_IN (BALI)      |
| 3. NAJWA SABILA_HABIBIE (INKANAS)              |
| 3. LISYE KASIH_SATIAMU_AS (SULAWESI UTARA)     |
| 5. LUSIANA BRISKIKA (ASKI)                     |
| 5. SALMA AULIA (INKAI)                         |
| 7. RAVENESIA CLAUDIA_TAMBUNAN_IN (DKI JAKARTA) |
| 7. FITRIA MAGITA_NOVA_BC (JAWA BARAT)          |

Referees:			

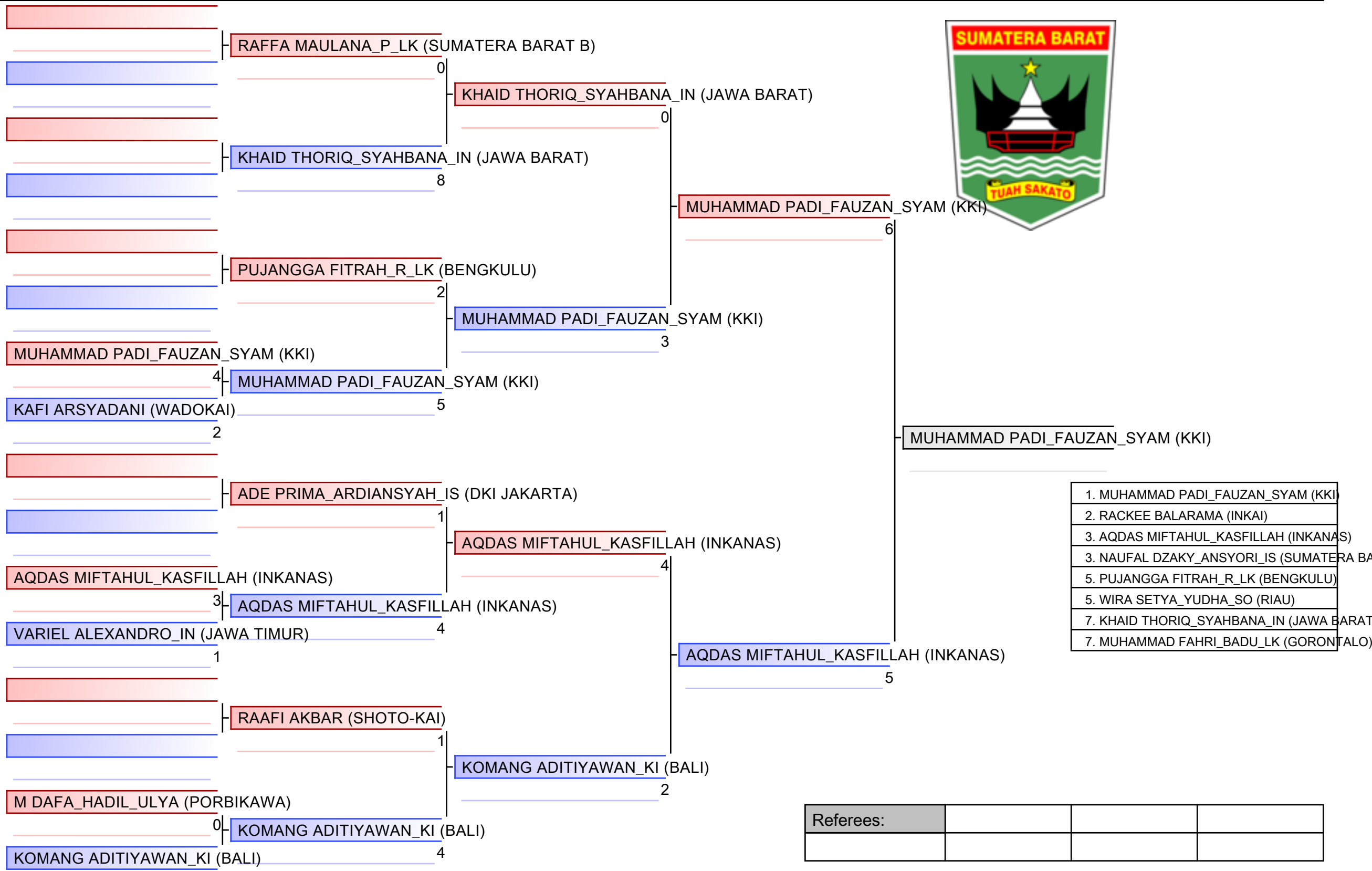

- |   |
|---|
| 1. MUHAMMAD PADI_FAUZAN_SYAM (KKI)          |
| 2. RACKEE BALARAMA (INKAI)                  |
| 3. AQDAS MIFTAHUL_KASFILLAH (INKANAS)       |
| 3. NAUFAL DZAKY_ANSYORI_IS (SUMATERA BARAT) |
| 5. PUJANGGA FITRAH_R_LK (BENGKULU)          |
| 5. WIRA SETYA_YUDHA_SO (RIAU)               |
| 7. KHAID THORIQ_SYAHBANA_IN (JAWA BARAT)    |
| 7. MUHAMMAD FAHRI_BADU_LK (GORONTALO)       |

Referees:			

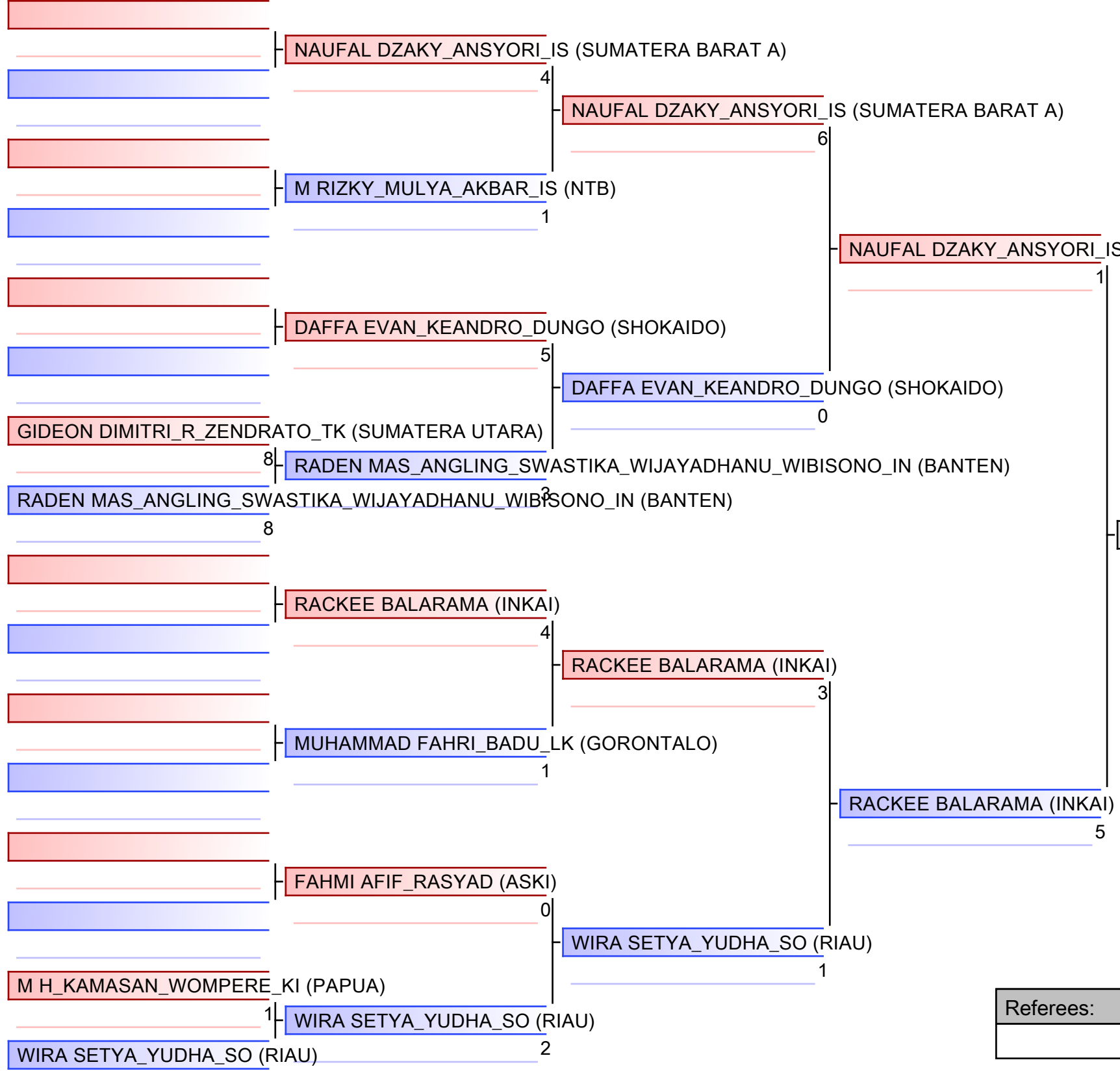

- |   |
|---|
| 1. MUHAMMAD PADI_FAUZAN_SYAM (KKI)            |
| 2. RACKEE BALARAMA (INKAI)                    |
| 3. AQDAS MIFTAHUL_KASFILLAH (INKANAS)         |
| 3. NAUFAL DZAKY_ANSYORI_IS (SUMATERA BARAT A) |
| 5. PUJANGGA FITRAH_R_LK (BENGKULU)            |
| 5. WIRA SETYA_YUDHA_SO (RIAU)                 |
| 7. KHAID THORIQ_SYAHBANA_IN (JAWA BARAT)      |
| 7. MUHAMMAD FAHRI_BADU_LK (GORONTALO)         |

Referees:			

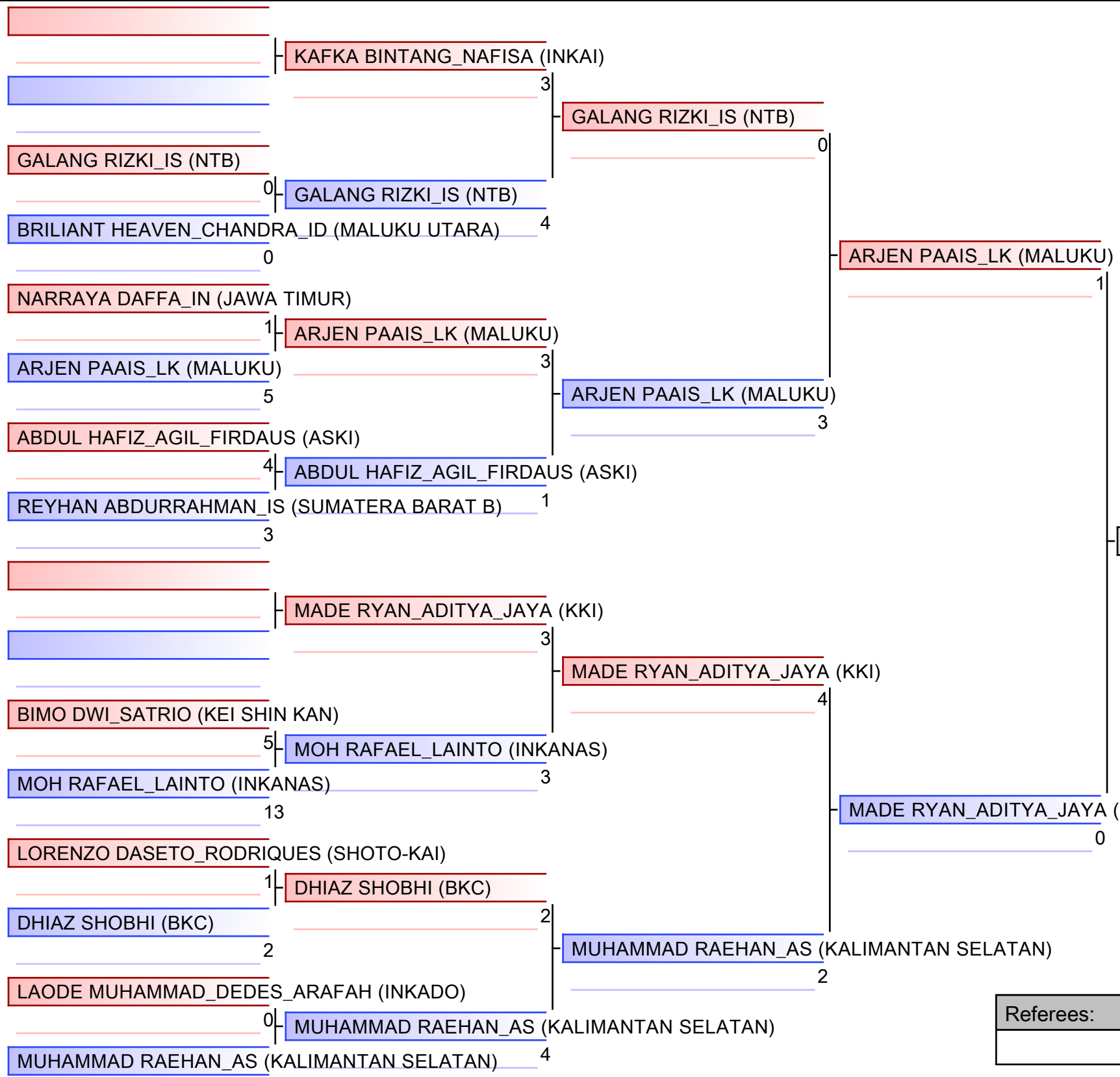

ARJEN PAAIS\_LK (MALUKU)

- |   |
|---|
| 1. M DHIJEY_LEXSIE_SI (SUMATERA UTARA)  |
| 2. ARJEN PAAIS_LK (MALUKU)              |
| 3. MADE RYAN_ADITYA_JAYA (KKI)          |
| 3. TIO TRIRALY_SAMBENTIRO (WADOKAI)     |
| 5. GALANG RIZKI_IS (NTB)                |
| 5. TAZKYA PUTRA_MASHUDI-IS (JAWA BARAT) |
| 7. ABDUL HAFIZ_AGIL_FIRDAUS (ASKI)      |
| 7. KOMANG TRI_WIDHIARDIKA (LEMKARI)     |

Referees:			

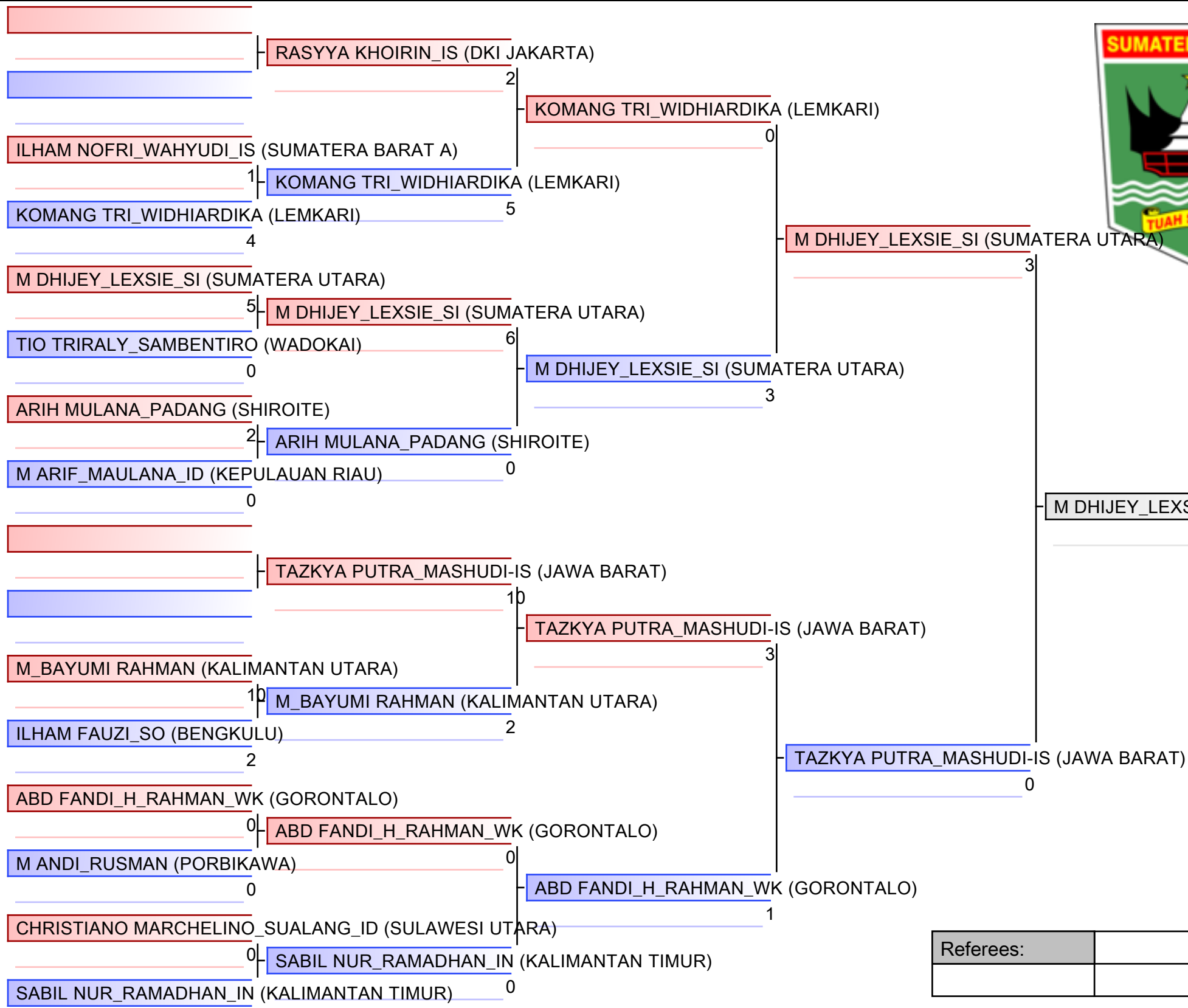

- |   |
|---|
| 1. M DHIJEY_LEXSIE_SI (SUMATERA UTARA)  |
| 2. ARJEN PAAIS_LK (MALUKU)              |
| 3. MADE RYAN_ADITYA_JAYA (KKI)          |
| 3. TIO TRIRALY_SAMBENTIRO (WADOKAI)     |
| 5. GALANG RIZKI_IS (NTB)                |
| 5. TAZKYA PUTRA_MASHUDI-IS (JAWA BARAT) |
| 7. ABDUL HAFIZ_AGIL_FIRDAUS (ASKI)      |
| 7. KOMANG TRI_WIDHIARDIKA (LEMKARI)     |

Referees:			



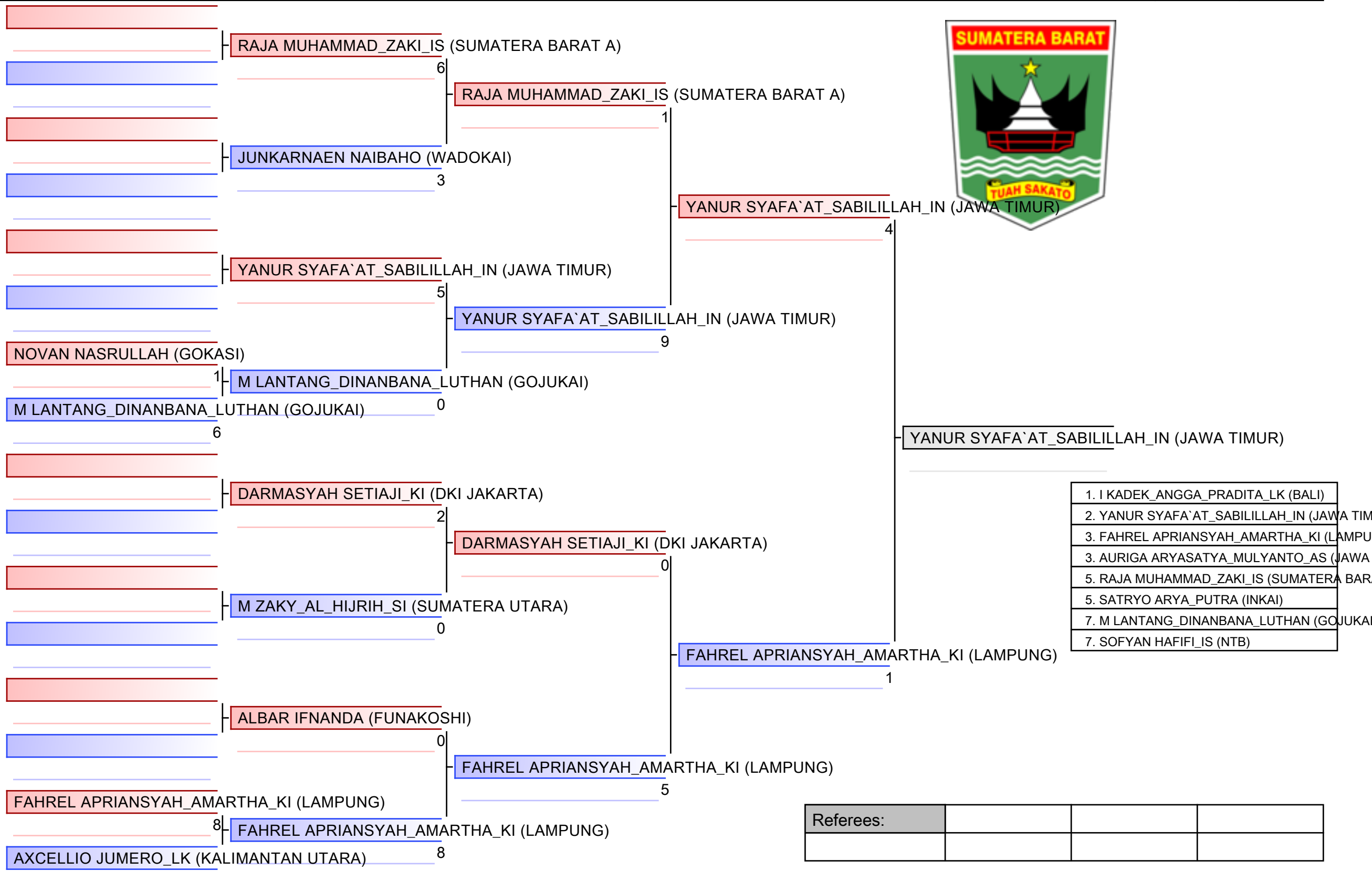

- |  |
|--|
| 1. I KADEK_ANGGA_PRADITA_LK (BALI)           |
| 2. YANUR SYAFA`AT_SABILILLAH_IN (JAWA TIMUR) |
| 3. FAHREL APRIANSYAH_AMARTHA_KI (LAMPUNG)    |
| 3. AURIGA ARYASATYA_MULYANTO_AS (JAWA T)     |
| 5. RAJA MUHAMMAD_ZAKI_IS (SUMATERA BARA)     |
| 5. SATRYO ARYA_PUTRA (INKAI)                 |
| 7. M LANTANG_DINANBANA_LUTHAN (GOJUKAI)      |
| 7. SOFYAN HAFIFI_IS (NTB)                    |

Referees:			

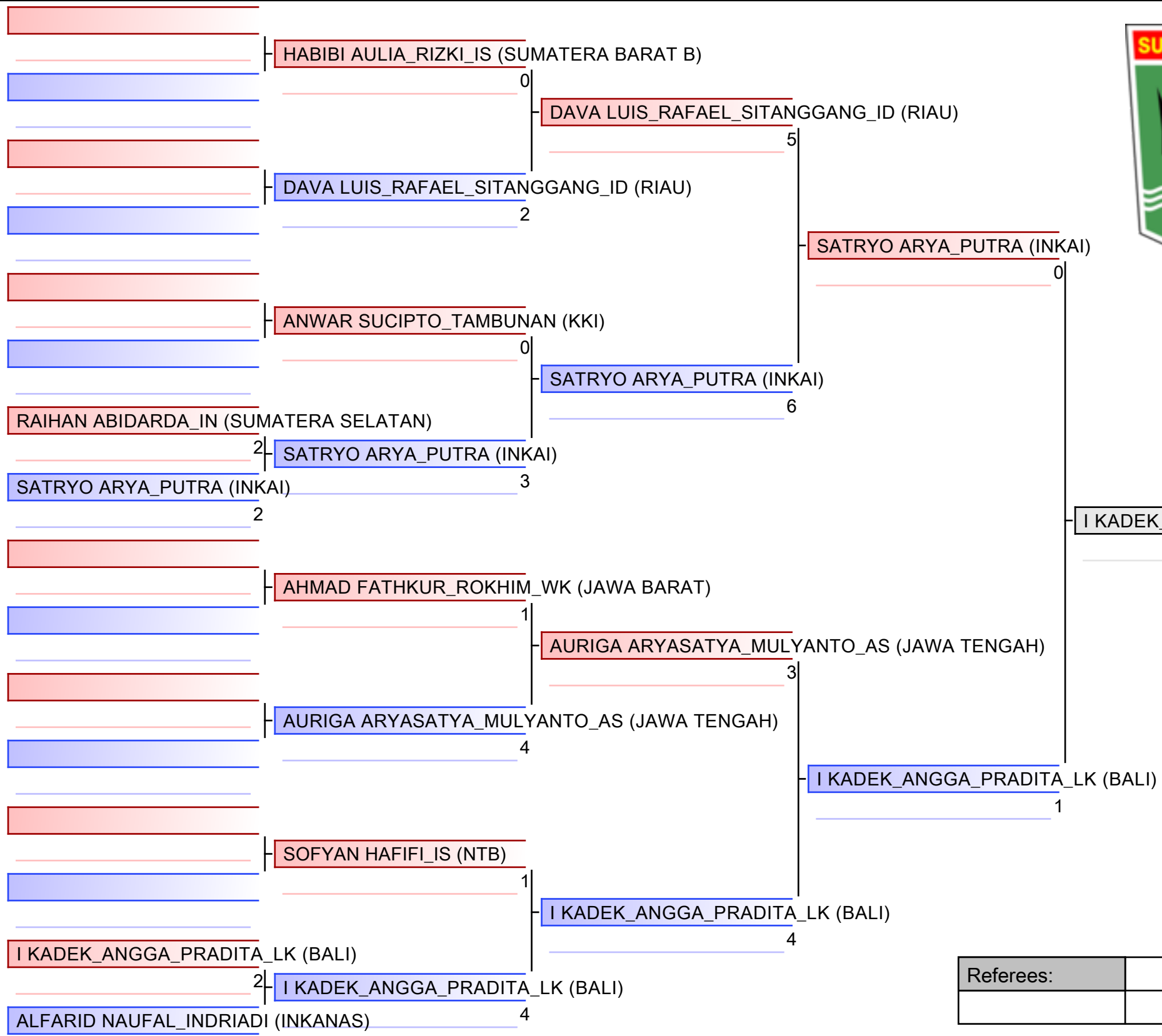

- |   |
|---|
| 1. I KADEK_ANGGA_PRADITA_LK (BALI)            |
| 2. YANUR SYAFA'AT_SABILILLAH_IN (JAWA TIMUR)  |
| 3. FAHREL APRIANSYAH_AMARTHA_KI (LAMPUNG)     |
| 3. AURIGA ARYASATYA_MULYANTO_AS (JAWA TENGAH) |
| 5. RAJA MUHAMMAD_ZAKI_IS (SUMATERA BARAT)     |
| 5. SATRYO ARYA_PUTRA (INKAI)                  |
| 7. M LANTANG_DINANBANA_LUTHAN (GOJUKAI)       |
| 7. SOFYAN HAFIFI_IS (NTB)                     |

Referees:			



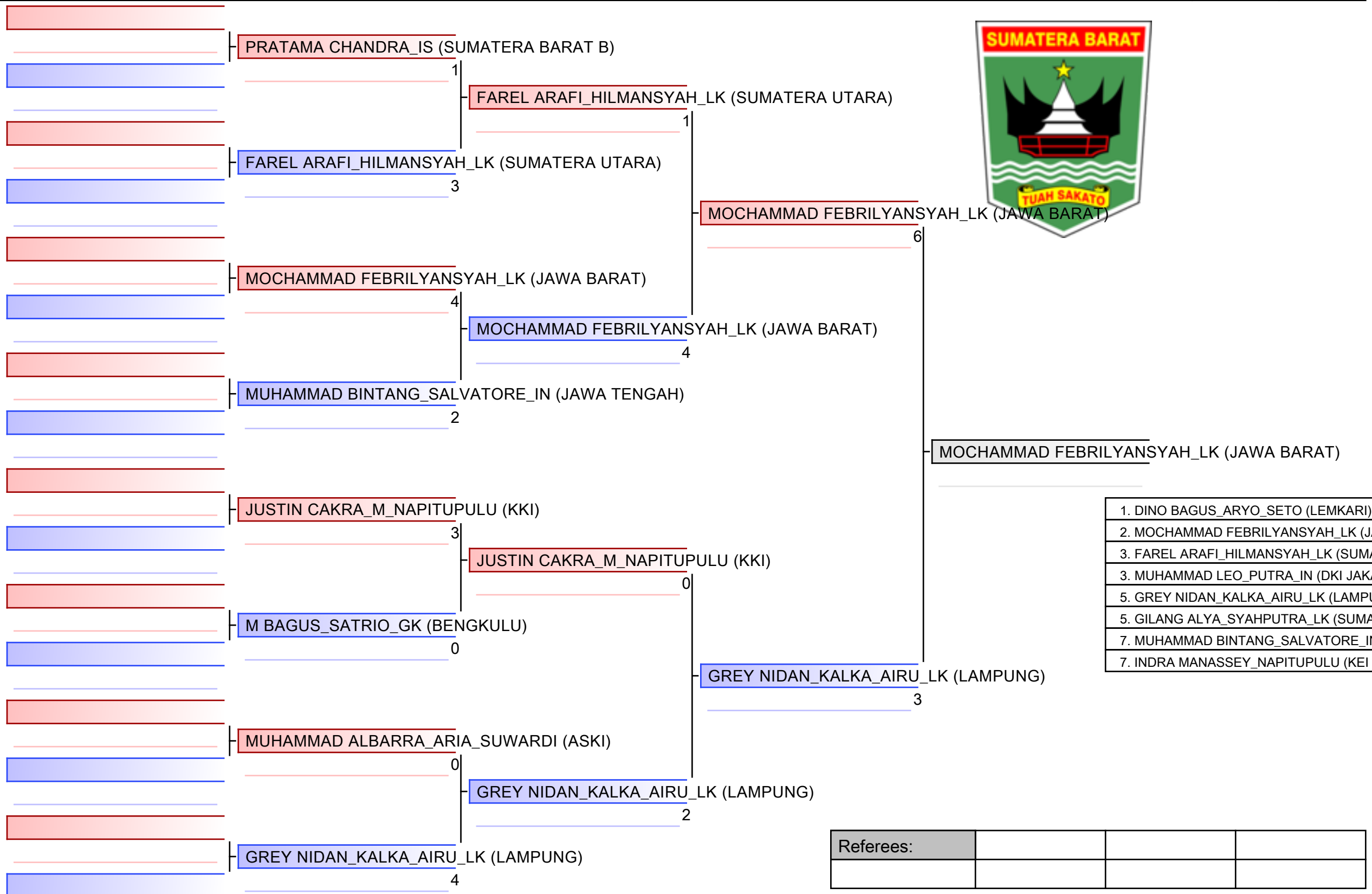

- 1. DINO BAGUS\_ARYO\_SETO (LEMKARI)
- 2. MOCHAMMAD FEBRILYANSYAH\_LK (JAWA BARAT)
- 3. FAREL ARAFI\_HILMANSYAH\_LK (SUMATERA UTARA)
- 3. MUHAMMAD LEO\_PUTRA\_IN (DKI JAKARTA)
- 5. GREY NIDAN\_KALKA\_AIRU\_LK (LAMPUNG)
- 5. GILANG ALYA\_SYAHPUTRA\_LK (SUMATERA BARAT)
- 7. MUHAMMAD BINTANG\_SALVATORE\_IN (JAWA TENGAH)
- 7. INDRA MANASSEY\_NAPITUPULU (KEI SHIN KARI)

Referees:			

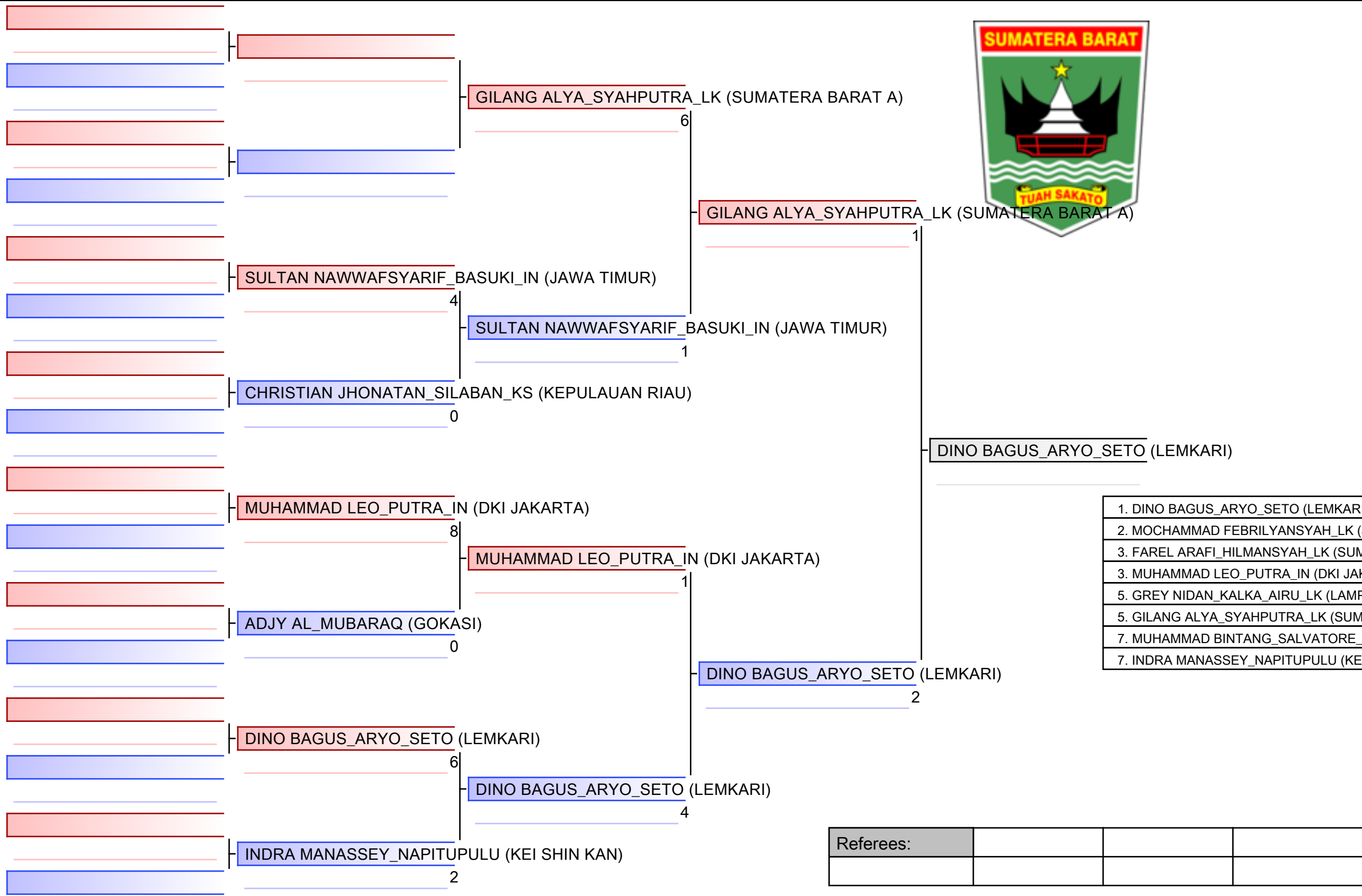

1. DINO BAGUS\_ARYO\_SETO (LEMKARI)
2. MOCHAMMAD FEBRILYANSYAH\_LK (JAWA BARAT)
3. FAREL ARAFI\_HILMANSYAH\_LK (SUMATERA UTARA)
3. MUHAMMAD LEO\_PUTRA\_IN (DKI JAKARTA)
5. GREY NIDAN\_KALKA\_AIRU\_LK (LAMPUNG)
5. GILANG ALYA\_SYAHPUTRA\_LK (SUMATERA BARAT)
7. MUHAMMAD BINTANG\_SALVATORE\_IN (JAWA BARAT)
7. INDRA MANASSEY\_NAPITUPULU (KEI SHIN KAN)

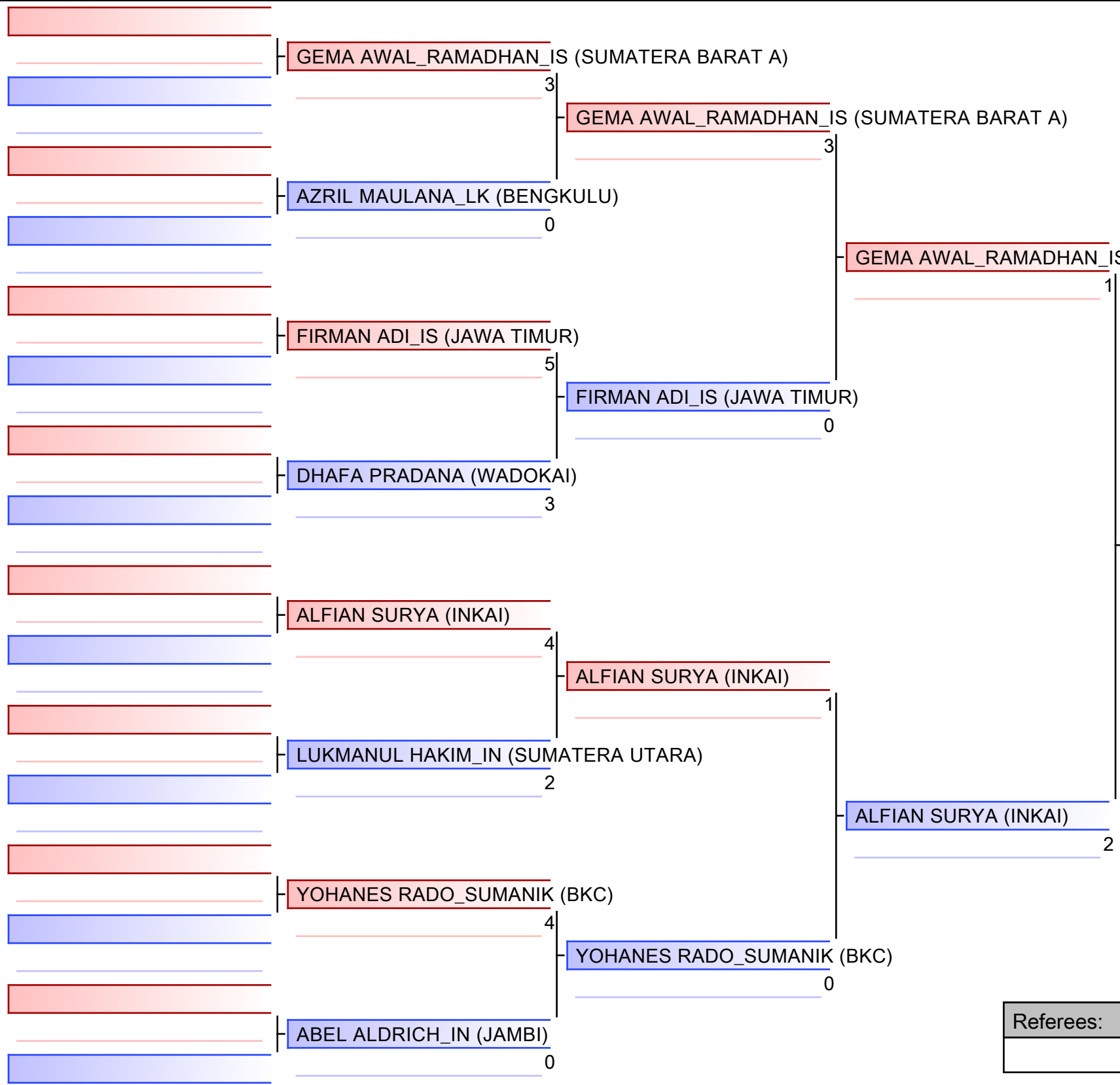

ALFIAN SURYA (INKAI)

- |   |
|---|
| 1. ALFIAN SURYA (INKAI)                     |
| 2. BILLY PASYAH_PURNOMO_BC (JAWA BARAT)     |
| 3. RAIHANI IRFANDA (LEMKARI)                |
| 3. YOHANES RADO_SUMANIK (BKC)               |
| 5. RIFFAT JUHLANSYAH_SOBARI (KKI)           |
| 5. GEMA AWAL_RAMADHAN_IS (SUMATERA BARAT A) |
| 7. WINTAMA DIMAS_FIQIH_KI (LAMPUNG)         |
| 7. LUKMANUL HAKIM_IN (SUMATERA UTARA)       |

Referees:			

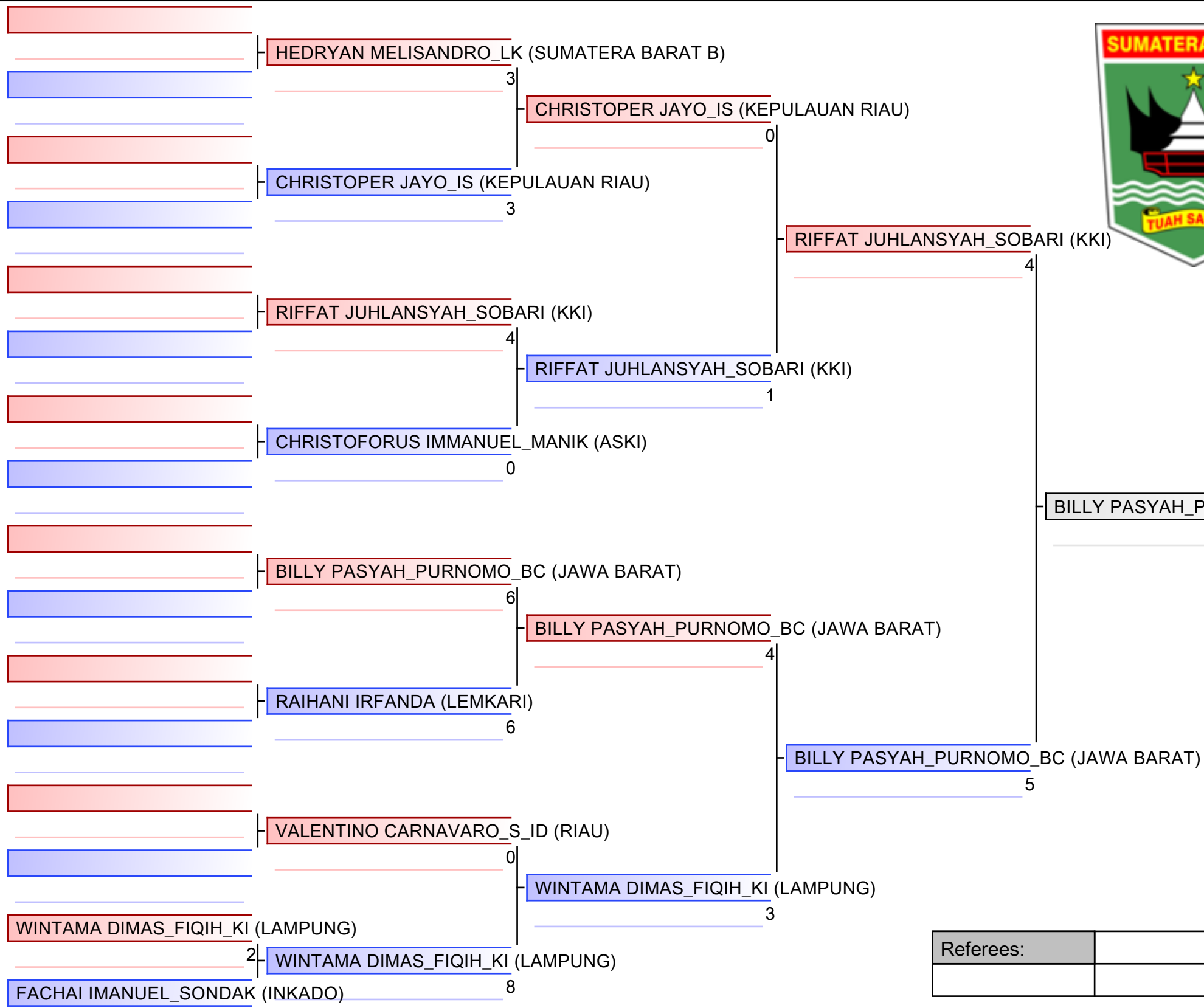

- |   |
|---|
| 1. ALFIAN SURYA (INKAI)                   |
| 2. BILLY PASYAH_PURNOMO_BC (JAWA BARAT)   |
| 3. RAIHANI IRFANDA (LEMKARI)              |
| 3. YOHANES RADO_SUMANIK (BKC)             |
| 5. RIFFAT JUHLANSYAH_SOBARI (KKI)         |
| 5. GEMA AWAL_RAMADHAN_IS (SUMATERA BARAT) |
| 7. WINTAMA DIMAS_FIQIH_KI (LAMPUNG)       |
| 7. LUKMANUL HAKIM_IN (SUMATERA UTARA)     |

Referees:			

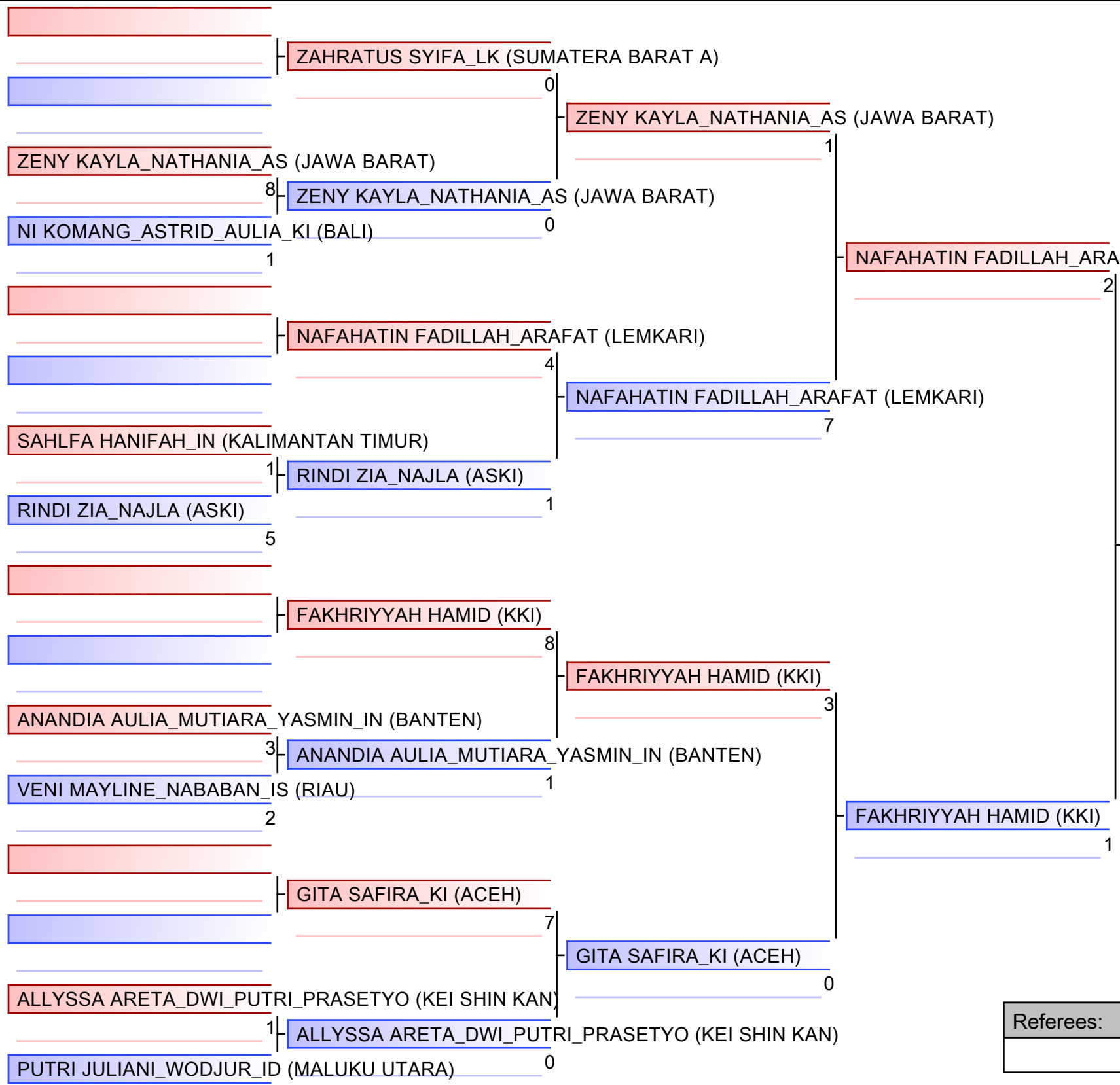

NAFAHATIN FADILLAH\_ARAFAT (LEMKARI)

- |   |
|---|
| 1. NAFAHATIN FADILLAH_ARAFAT (LEMKARI)    |
| 2. GHINA MUFIDA (GOJUKAI)                 |
| 3. RAHMATIKA DWI_WAHYUNINGRUM (INKAI)     |
| 3. FAKHRIYYAH HAMID (KKI)                 |
| 5. ALODYA VARISSA_KHAWISWARA_BC (JAWA T)  |
| 5. ZENY KAYLA_NATHANIA_AS (JAWA BARAT)    |
| 7. KURNIA PUTRI_IVANA_IS (SUMATERA BARAT) |
| 7. RINDI ZIA_NAJLA (ASKI)                 |

Referees:			

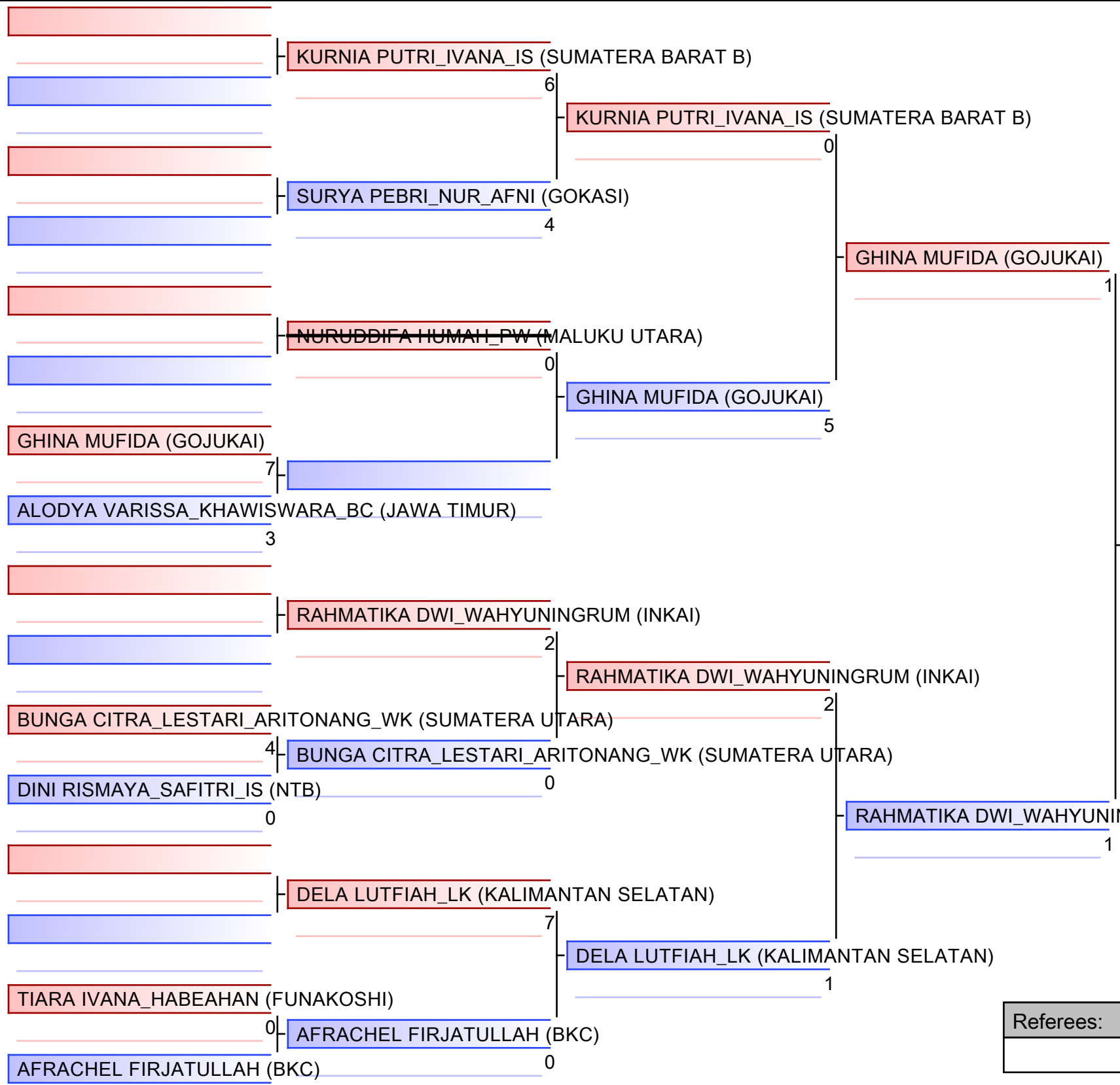

- |   |
|---|
| 1. NAFAHATIN FADILLAH_ARAFAT (LEMKARI)    |
| 2. GHINA MUFIDA (GOJUKAI)                 |
| 3. RAHMATIKA DWI_WAHYUNINGRUM (INKAI)     |
| 3. FAKHRIYYAH HAMID (KKI)                 |
| 5. ALODYA VARISSA_KHAWISWARA_BC (JAWA T)  |
| 5. ZENY KAYLA_NATHANIA_AS (JAWA BARAT)    |
| 7. KURNIA PUTRI_IVANA_IS (SUMATERA BARAT) |
| 7. RINDI ZIA_NAJLA (ASKI)                 |

Referees:			

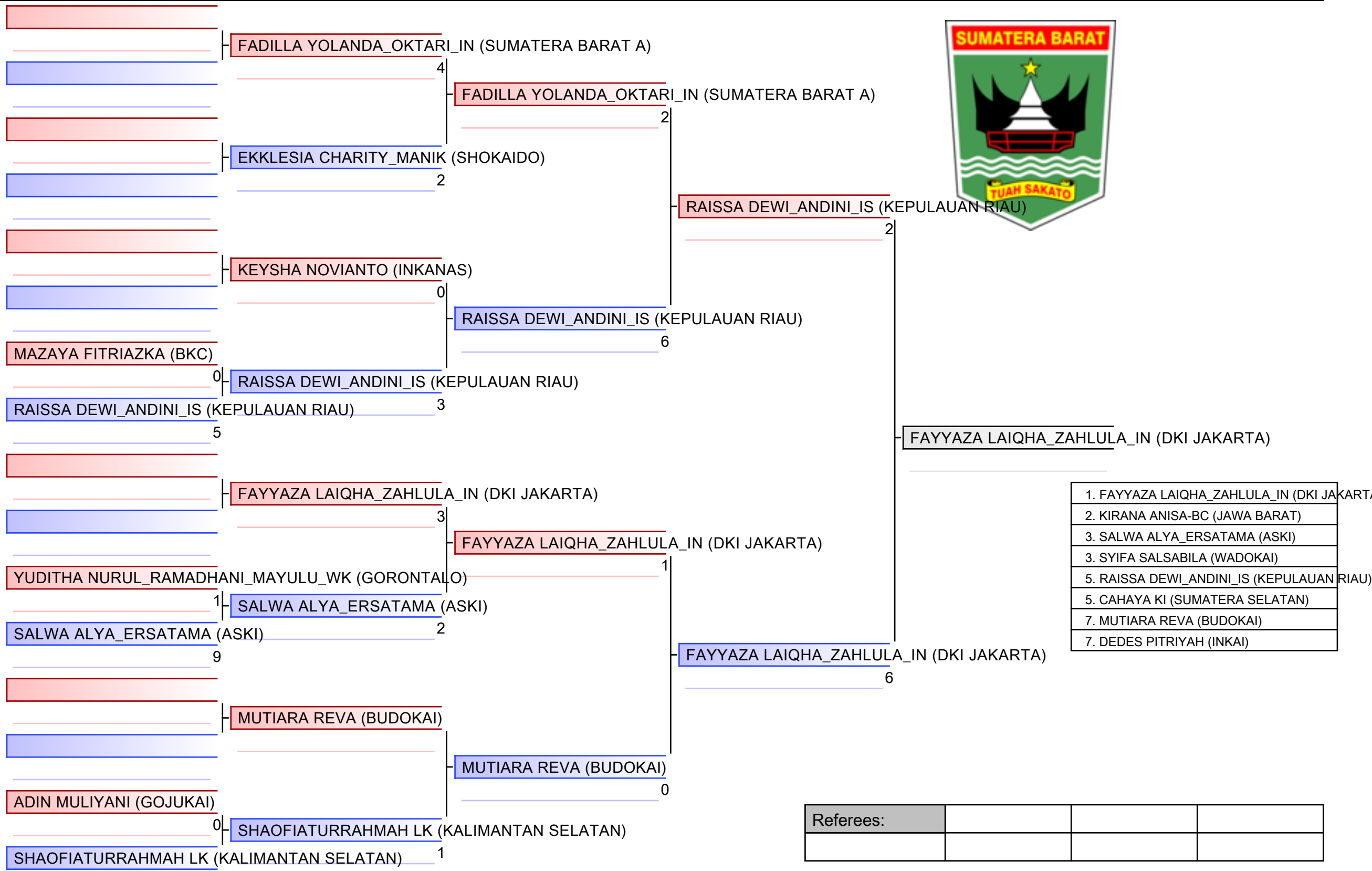

- |  |
|--|
| 1. FAYYAZA LAIQHA_ZAHLULA_IN (DKI JAKARTA) |
| 2. KIRANA ANISA-BC (JAWA BARAT)            |
| 3. SALWA ALYA_ERSATAMA (ASKI)              |
| 3. SYIFA SALSABILA (WADOKAI)               |
| 5. RAISSA DEWI_ANDINI_IS (KEPULAUAN RIAU)  |
| 5. CAHAYA KI (SUMATERA SELATAN)            |
| 7. MUTIARA REVA (BUDOKAI)                  |
| 7. DEDES PITRIYAH (INKAI)                  |

Referees:			



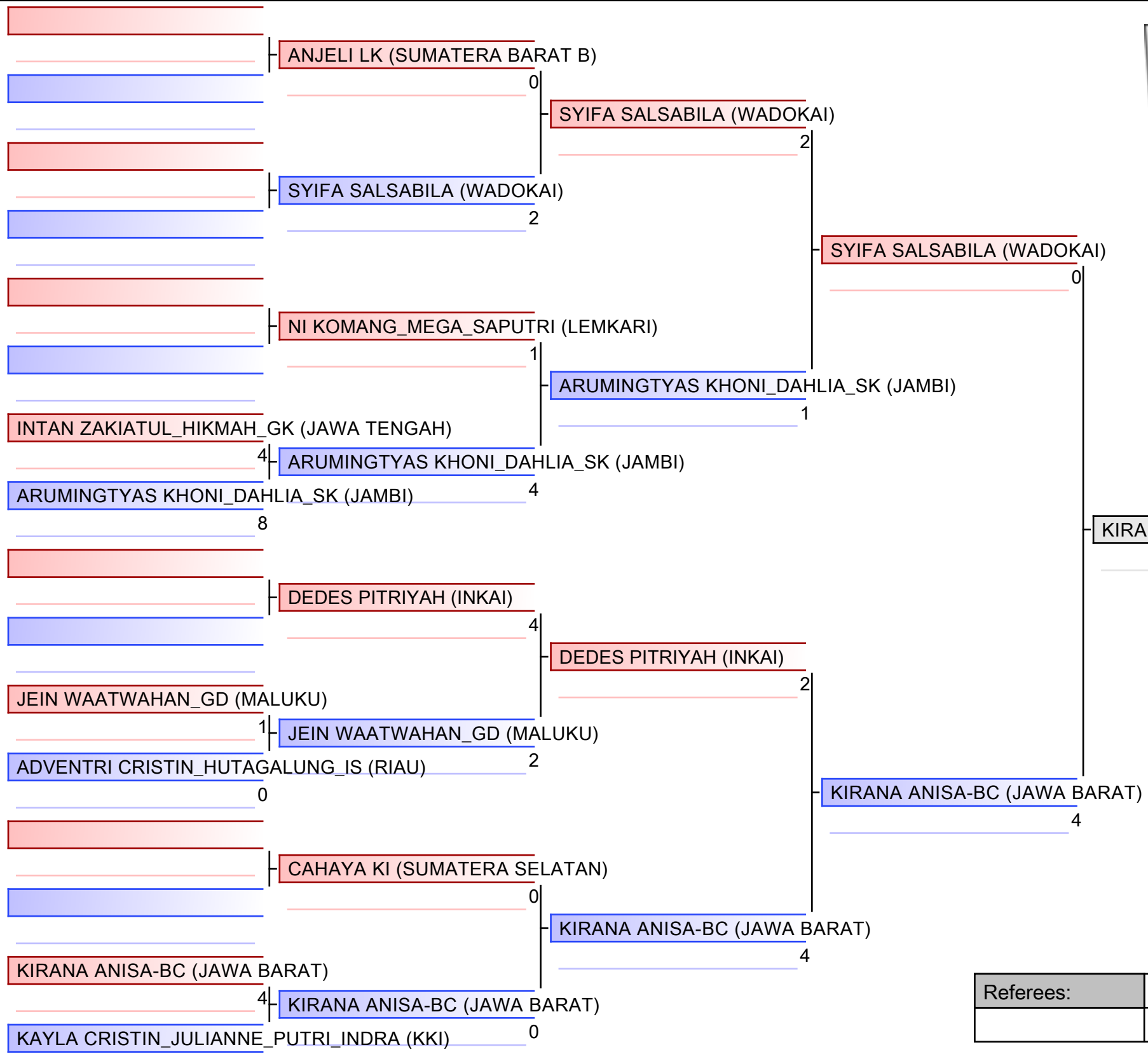

- |  |
|--|
| 1. FAYYAZA LAIQHA_ZAHLULA_IN (DKI JAKARTA) |
| 2. KIRANA ANISA-BC (JAWA BARAT)            |
| 3. SALWA ALYA_ERSATAMA (ASKI)              |
| 3. SYIFA SALSABILA (WADOKAI)               |
| 5. RAISSA DEWI_ANDINI_IS (KEPULAUAN RIAU)  |
| 5. CAHAYA KI (SUMATERA SELATAN)            |
| 7. MUTIARA REVA (BUDOKAI)                  |
| 7. DEDES PITRIYAH (INKAI)                  |

Referees:			



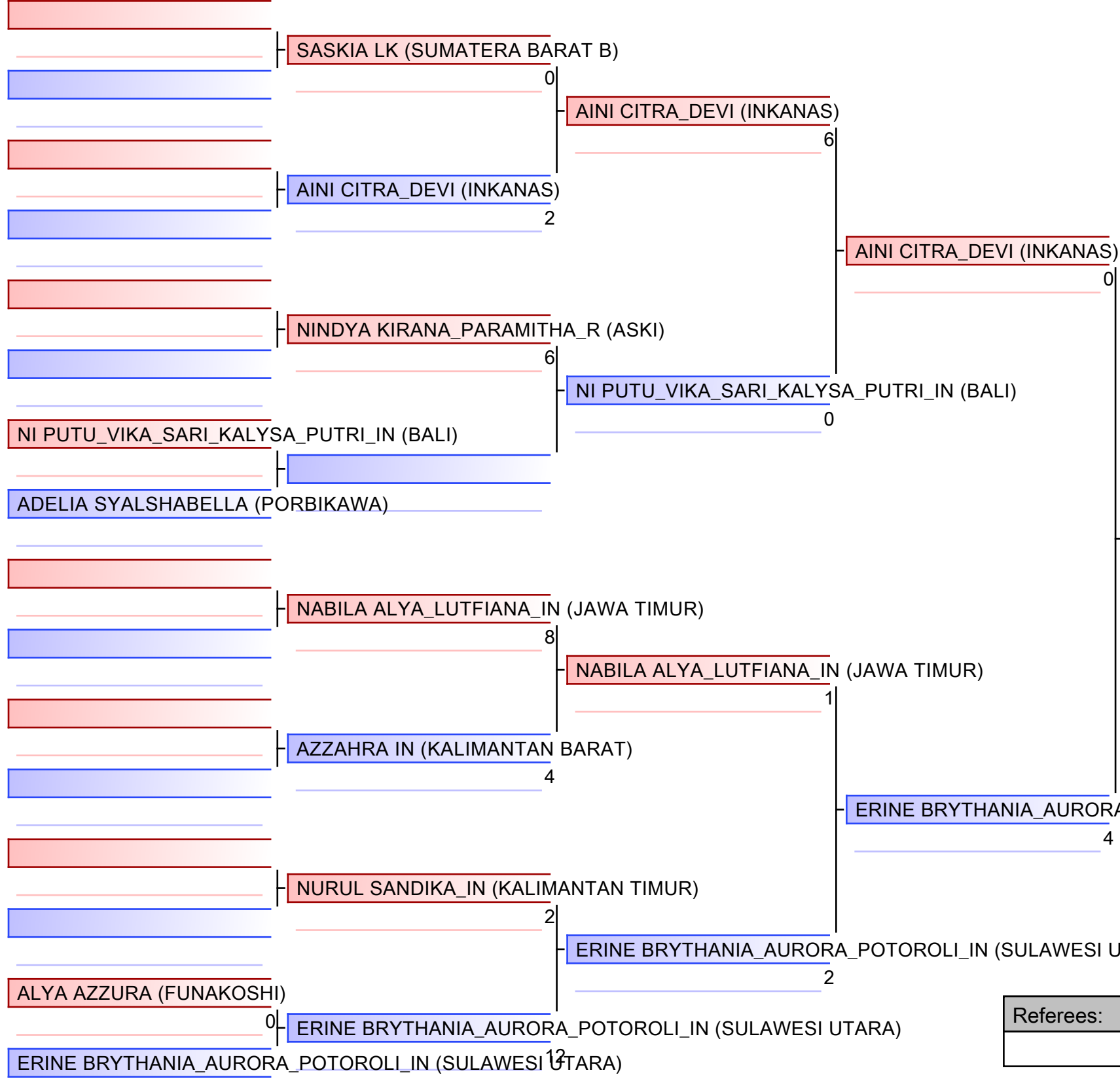

ERINE BRYTHANIA\_AURORA\_POTOROLI\_IN (SULAWESI UTARA)

- |  |
|--|
| 1. ERINE BRYTHANIA_AURORA_POTOROLI_IN (SULAWESI UTARA) |
| 2. NADHYA IS (JAWA BARAT)                              |
| 3. AINI CITRA_DEVI (INKANAS)                           |
| 3. LUTHFIA ALINI_KI (ACEH)                             |
| 5. NABILA ALYA_LUTFIANA_IN (JAWA TIMUR)                |
| 5. ANJIRA KI (SUMATERA UTARA)                          |
| 7. NURUL SANDIKA_IN (KALIMANTAN TIMUR)                 |
| 7. RENATA DWINANDA_ZARRA_ID (SUMATERA BARAT)           |

Referees:			

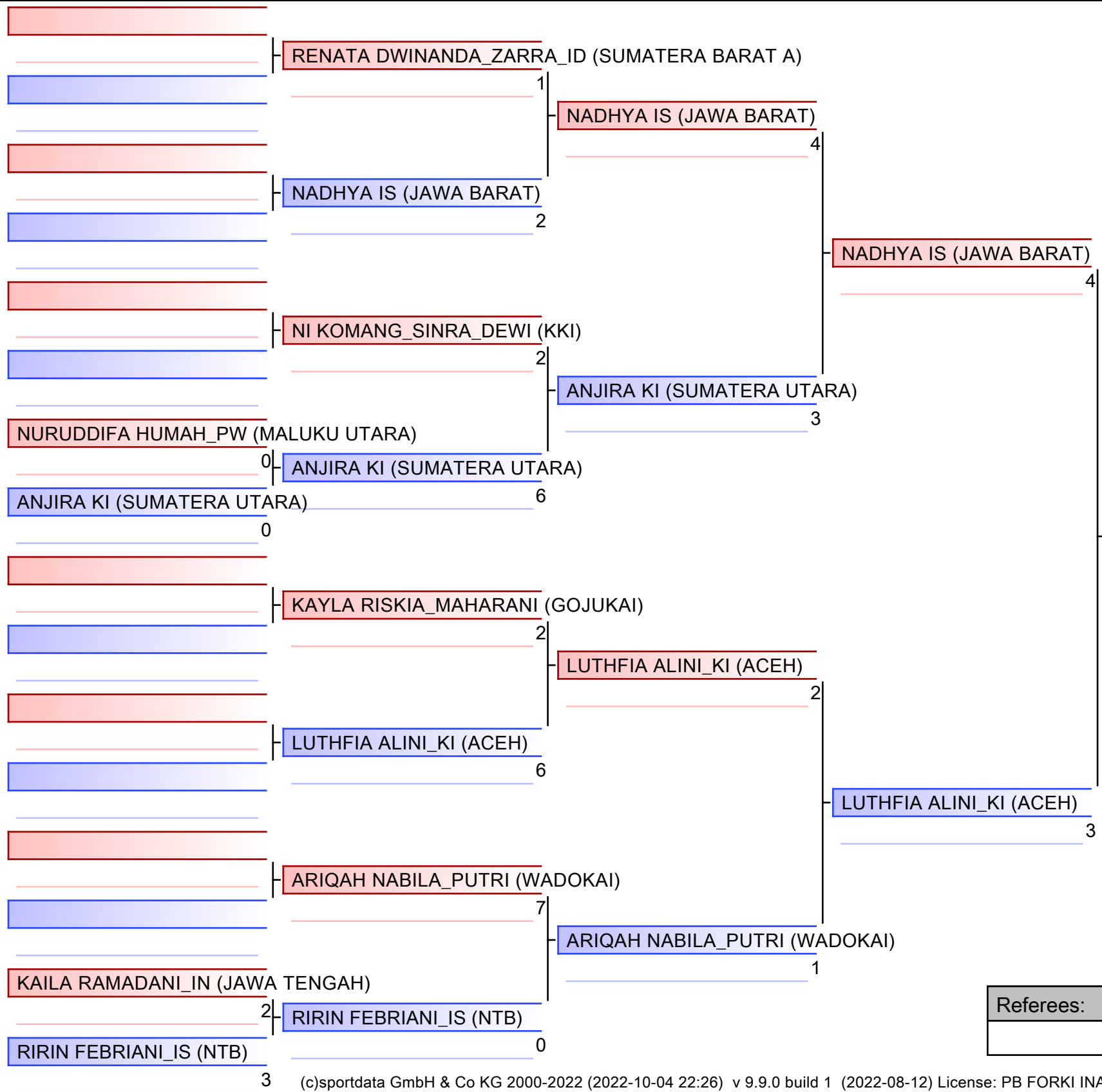

NADHYA IS (JAWA BARAT)

- |   |
|---|
| 1. ERINE BRYTHANIA_AURORA_POTOROLI_IN (S) |
| 2. NADHYA IS (JAWA BARAT)                 |
| 3. AINI CITRA_DEVI (INKANAS)              |
| 3. LUTHFIA ALINI_KI (ACEH)                |
| 5. NABILA ALYA_LUTFIANA_IN (JAWA TIMUR)   |
| 5. ANJIRA KI (SUMATERA UTARA)             |
| 7. NURUL SANDIKA_IN (KALIMANTAN TIMUR)    |
| 7. RENATA DWINANDA_ZARRA_ID (SUMATERA B)  |

Referees:			

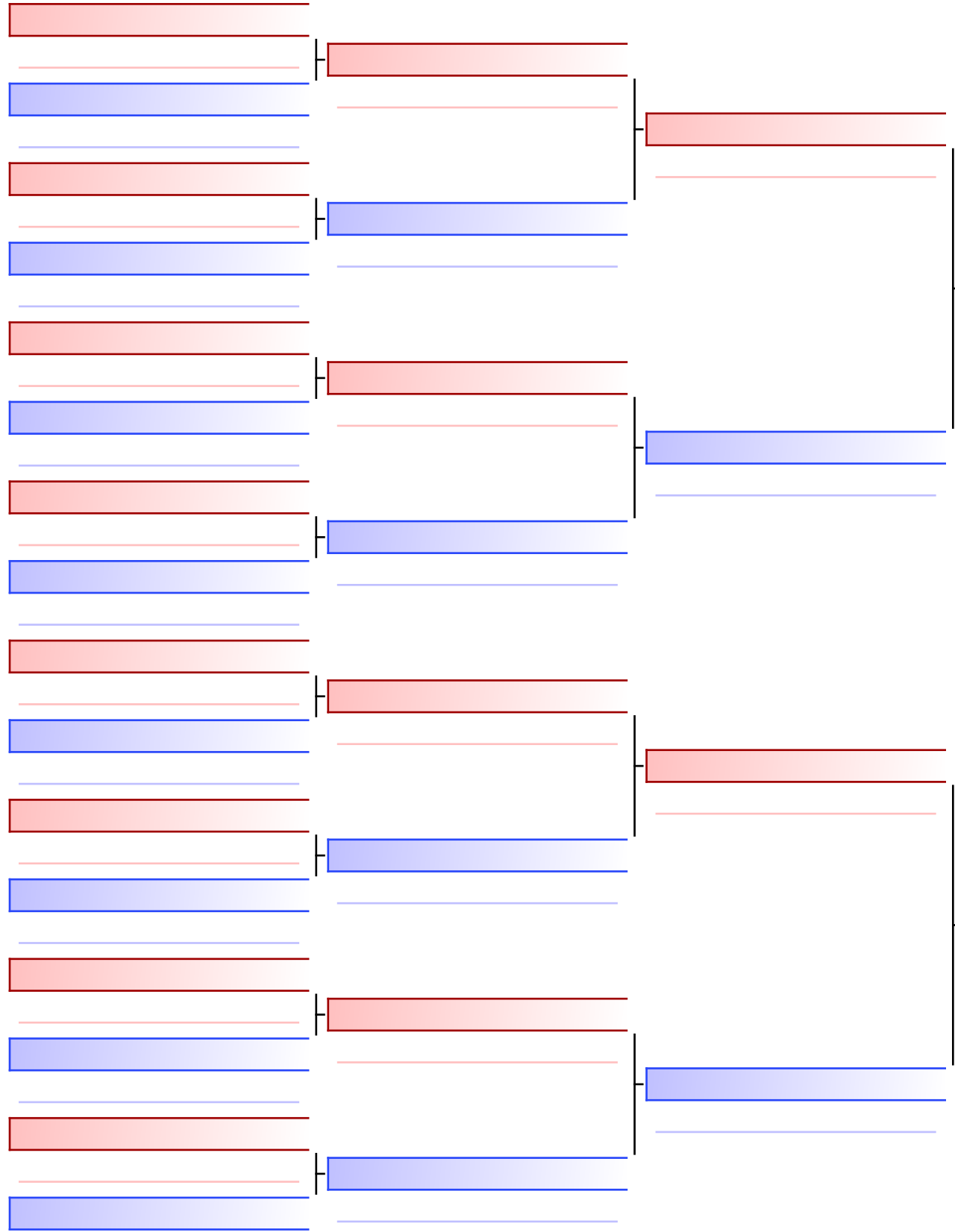

Final

I GEDE\_ARYA\_PUJA\_ADNYANA (KKI)  
 3

I GEDE\_ARYA\_PUJA\_ADNYANA (KKI)

SIN AHMAD\_QODDRIH\_KI (LAMPUNG)  
 0

- |   |
|---|
| 1. I GEDE_ARYA_PUJA_ADNYANA (KKI)           |
| 2. SIN AHMAD_QODDRIH_KI (LAMPUNG)           |
| 3. RADAR STEAGEAL_SEJATI_IS (JAWA BARAT)    |
| 3. MADE ANDIKA_PRAMANA_PUTRA_KI (BALI)      |
| 5. MARCHO MARCHELO_CHRISTIAN_TELLENG_A      |
| 5. RAMAKRISHNA YOGANANDA (INKADO)           |
| 7. MUH ALFARIZI_DZIKRI_IN (SULAWESI TENGAH) |
| 7. PABRAMROE PASAISTRA_AS (DIY)             |

Referees:			

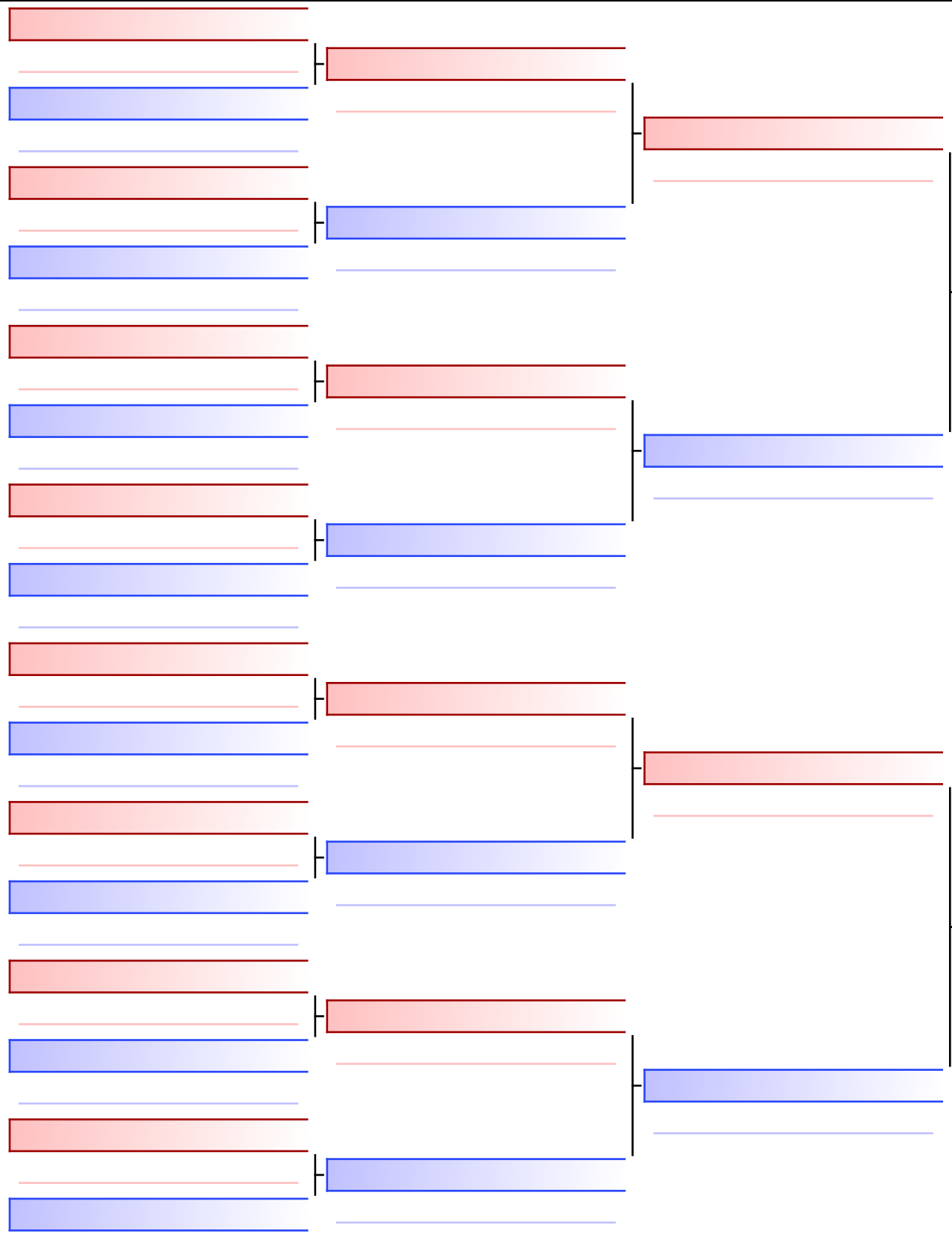

Final  
 JOSEPH MARIANNO\_RATHZINGER\_IN (DKI JAKARTA)

DAFFA FAALIH\_ANANTA (ASKI)

- |  |
|--|
| 1. JOSEPH MARIANNO_RATHZINGER_IN (DKI JAKARTA) |
| 2. DAFFA FAALIH_ANANTA (ASKI)                  |
| 3. YOHANES MUHAMAD_RAMDAN_KI (JAWA BARAT)      |
| 3. MUHAMMAD IMAM_KI (ACEH)                     |
| 5. ANDHIKA MICHOLA_IS (SUMATERA BARAT A)       |
| 5. M HAFIDZ_ALZAVARAN (SHOKAIDO)               |
| 7. HUMAN IRSYAD_SABIL (GOJUKAI)                |
| 7. DISMA SANG_W_IN (KALIMANTAN TIMUR)          |

Referees:			

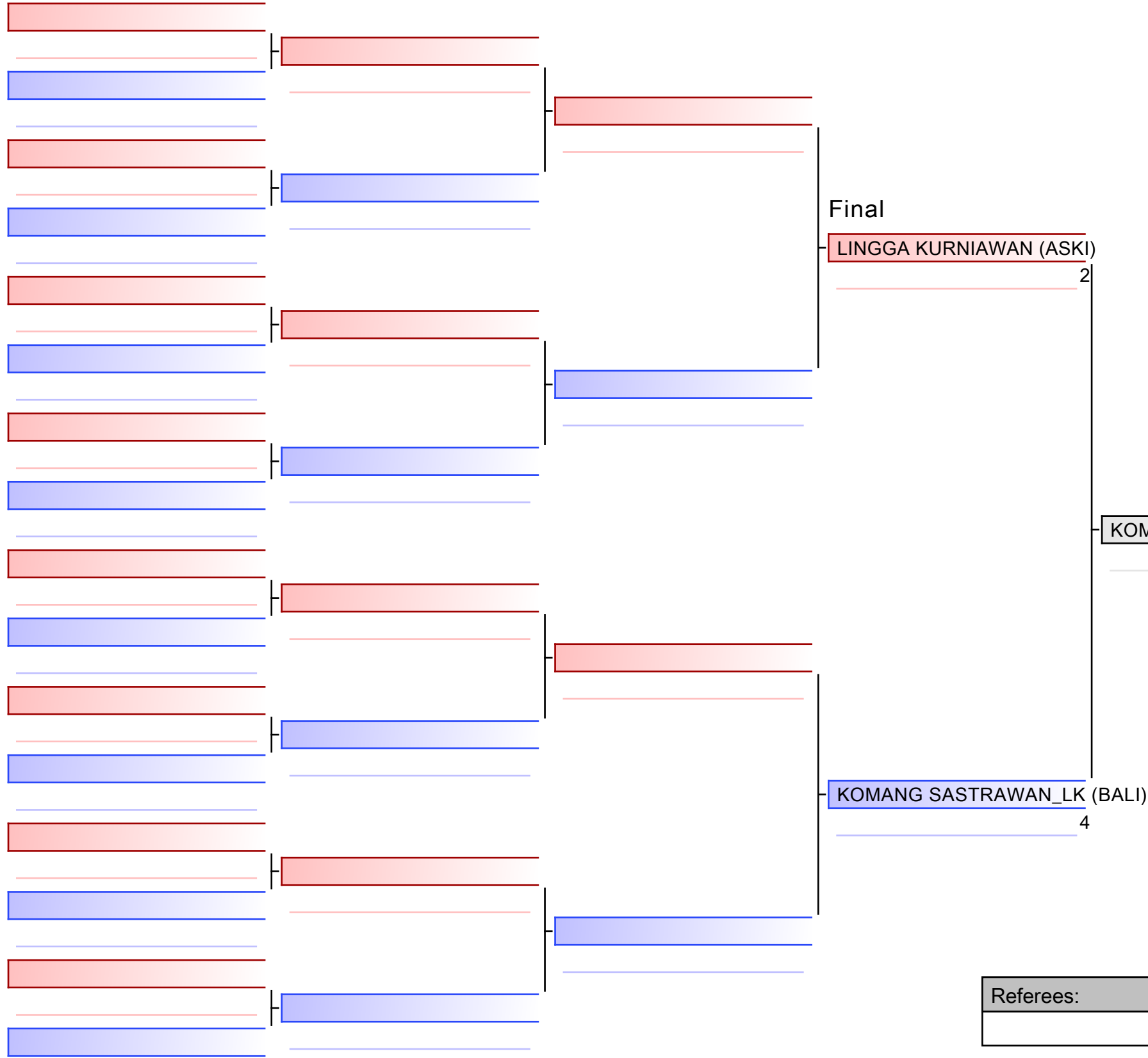

- |                                      |
|--------------------------------------|
| 1. KOMANG SASTRAWAN_LK (BALI)        |
| 2. LINGGA KURNIAWAN (ASKI)           |
| 3. L MUHAMMAD_AZWIN (INKAI)          |
| 3. AHMAD ALAYDRUS_IN (JAWA TIMUR)    |
| 5. ABIZAR IS (SUMATERA SELATAN)      |
| 5. MUHAMMAD YAHYA_GHIFARI (SHINDOKA) |
| 7. KADEK PRINCE_SADWIKI_SHANDY (KKI) |
| 7. AJI IS (SUMATERA UTARA)           |

Referees:			

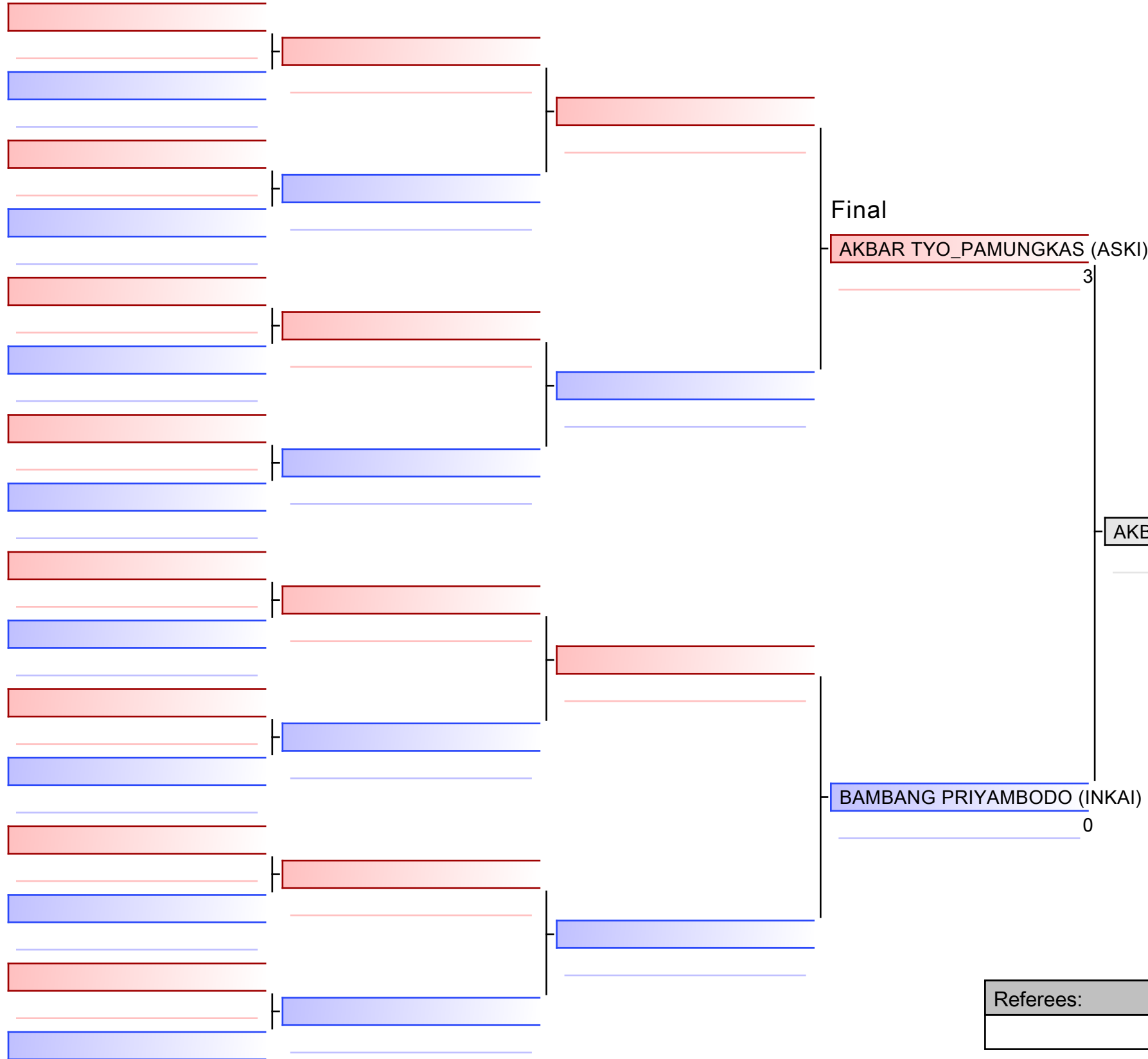

AKBAR TYO\_PAMUNGKAS (ASKI)

- |   |
|---|
| 1. AKBAR TYO_PAMUNGKAS (ASKI)                   |
| 2. BAMBANG PRIYAMBODO (INKAI)                   |
| 3. FIRMAN GENTURIN (JAWA TIMUR)                 |
| 3. DAIVA MAHADANA_IS (DKI JAKARTA)              |
| 5. ANDIKA HULIO_PRATAMA_BECKHAM_KI (LAMAR)      |
| 5. AHMAD WAHIDIN_SAPUTRA_IN (JAMBI)             |
| 7. MICHAEL CHARIS_SHEVCHENKO_KARWUR (INDONESIA) |
| 7. RAJO BINTANG_IS (SUMATERA BARAT A)           |

Referees:			

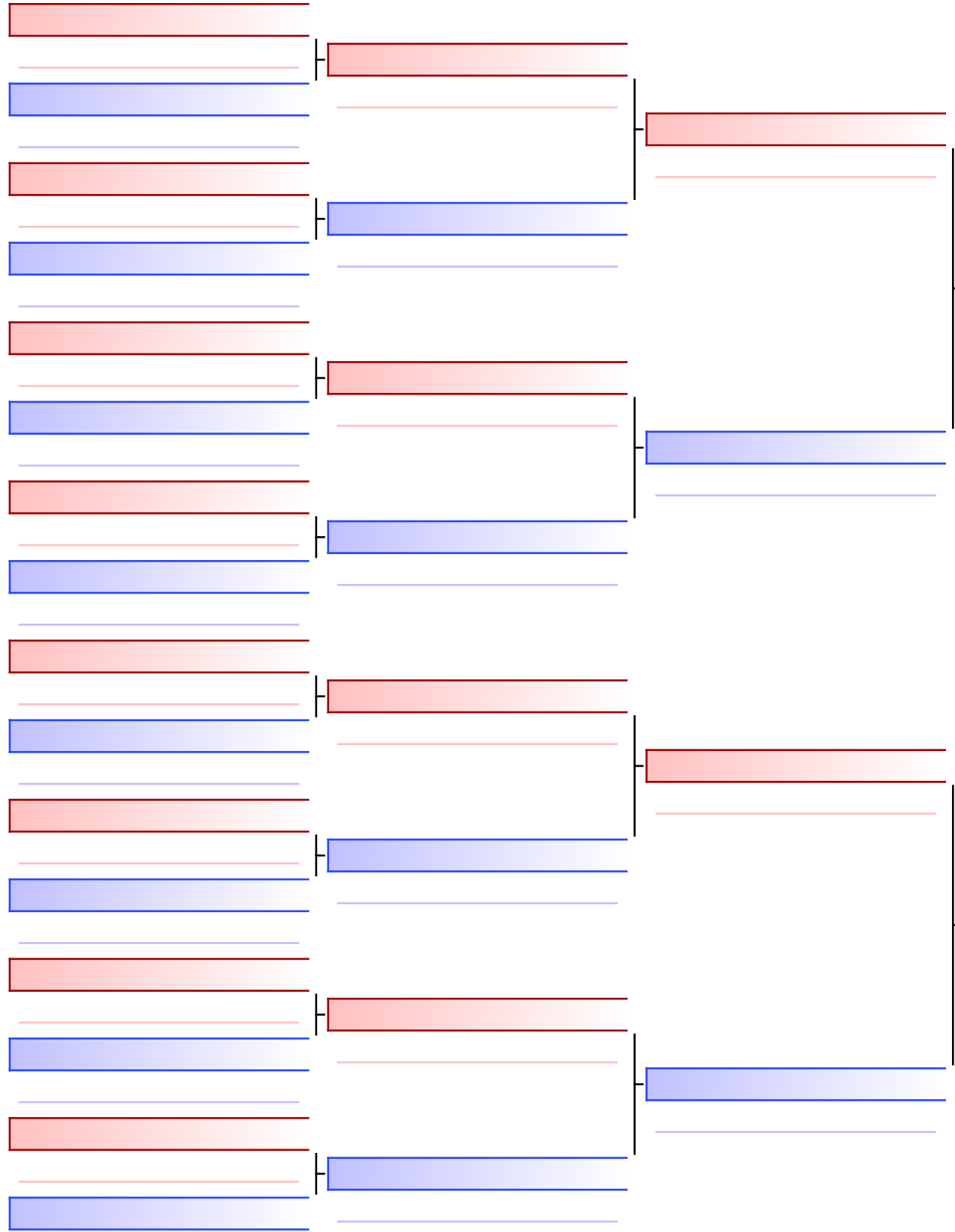

Final

NATHANIEL ABIMANYU (ASKI)  
 8

NATHANIEL ABIMANYU (ASKI)

FX ALVONSSE\_WIDYANSYAH (SHOTO-KAI)  
 0



- |  |
|--|
| 1. NATHANIEL ABIMANYU (ASKI)               |
| 2. FX ALVONSSE_WIDYANSYAH (SHOTO-KAI)      |
| 3. MUHAMMAD YUSUF_SYHADAN (INKADO)         |
| 3. BRILLYAN DIMAS_BAGASKARA (INKAI)        |
| 5. MUHAMMAD FIKRI (INKANAS)                |
| 5. MUHAMMAD AL_FAJAR_ID (SULAWESI SELATAN) |
| 7. MUHAMMAD RIDHO_PURWADI (FUNAKOSHI)      |
| 7. RIFKY ARDIANSYAH_LK (SUMATERA UTARA)    |

Referees:			



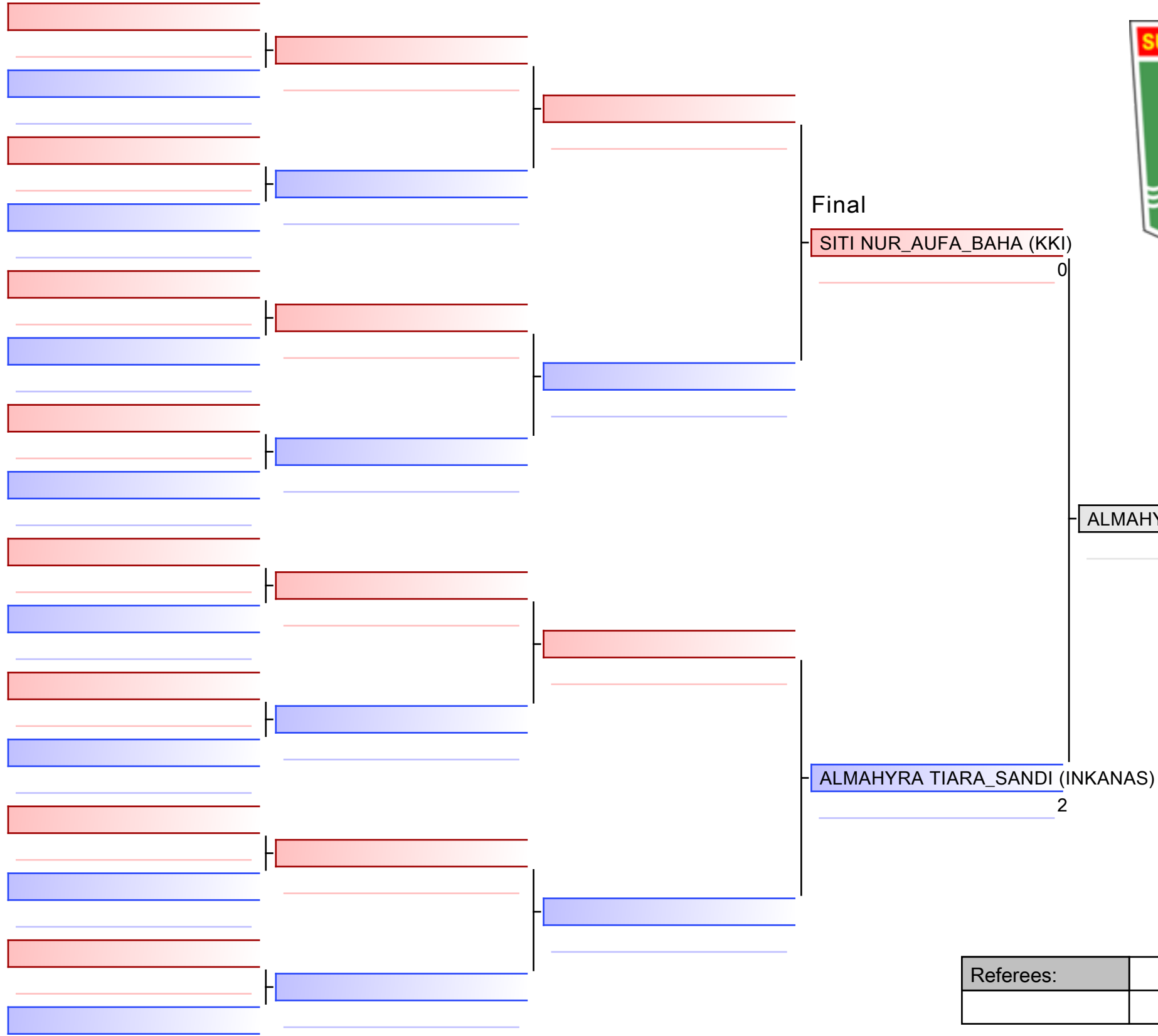

- |   |
|---|
| 1. ALMAHYRA TIARA_SANDI (INKANAS)         |
| 2. SITI NUR_AUFA_BAHA (KKI)               |
| 3. SAUSAN AULIA_SESI_IN (BANTEN)          |
| 3. MEIVIONA ZUHRINA_WK (SUMATERA UTARA)   |
| 5. RAYVA IMELDA_SAMBENTHIRO (WADOKAI)     |
| 5. ABYGAIL THERESA_SENDOW (INKADO)        |
| 7. REZKI TRI_ANDINI_KI (SULAWESI SELATAN) |
| 7. GITA DAMAYANTI_IS (JAWA TIMUR)         |

Referees:			

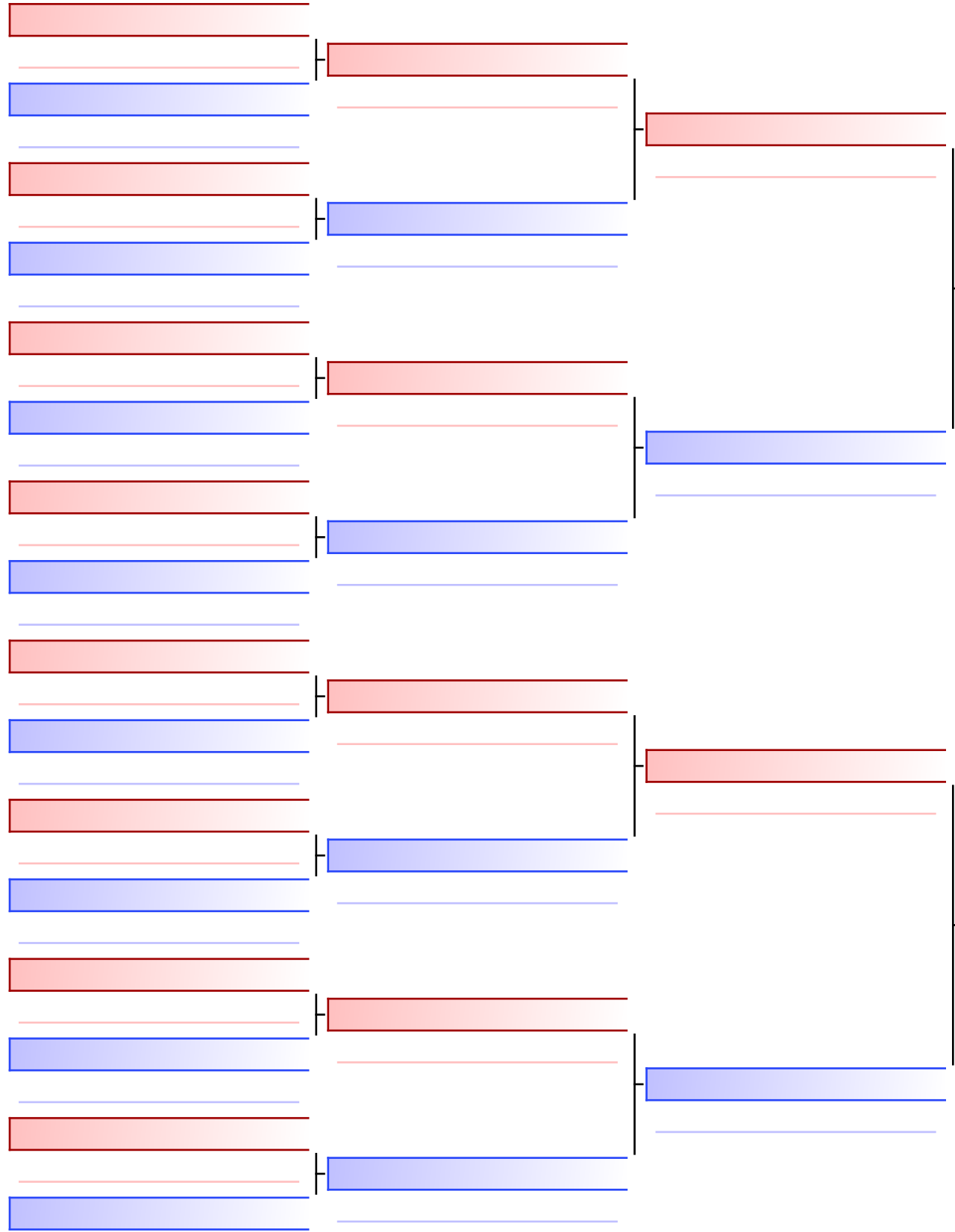

Final

REYGISTA DWI\_AMANDA\_KI (DKI JAKARTA)

6

REYGISTA DWI\_AMANDA\_KI (DKI JAKARTA)

MULIA JISCHA\_CHERRYL\_S\_IS (JAWA TIMUR)

3



- |   |
|---|
| 1. REYGISTA DWI_AMANDA_KI (DKI JAKARTA)   |
| 2. MULIA JISCHA_CHERRYL_S_IS (JAWA TIMUR) |
| 3. ALYA DEANTI_SUTENDI_IN (JAWA BARAT)    |
| 3. SYERIEL DEBORA_WENNO (INKANAS)         |
| 5. FITRISYA HENDITA_LK (SUMATERA BARAT B) |
| 5. NUR AINI_IS (SUMATERA BARAT A)         |
| 7. VINA ANUGERAH_A_IS (KALIMANTAN TIMUR)  |
| 7. NADIA ULVA_SARI_SK (BENGKULU)          |

Referees:			

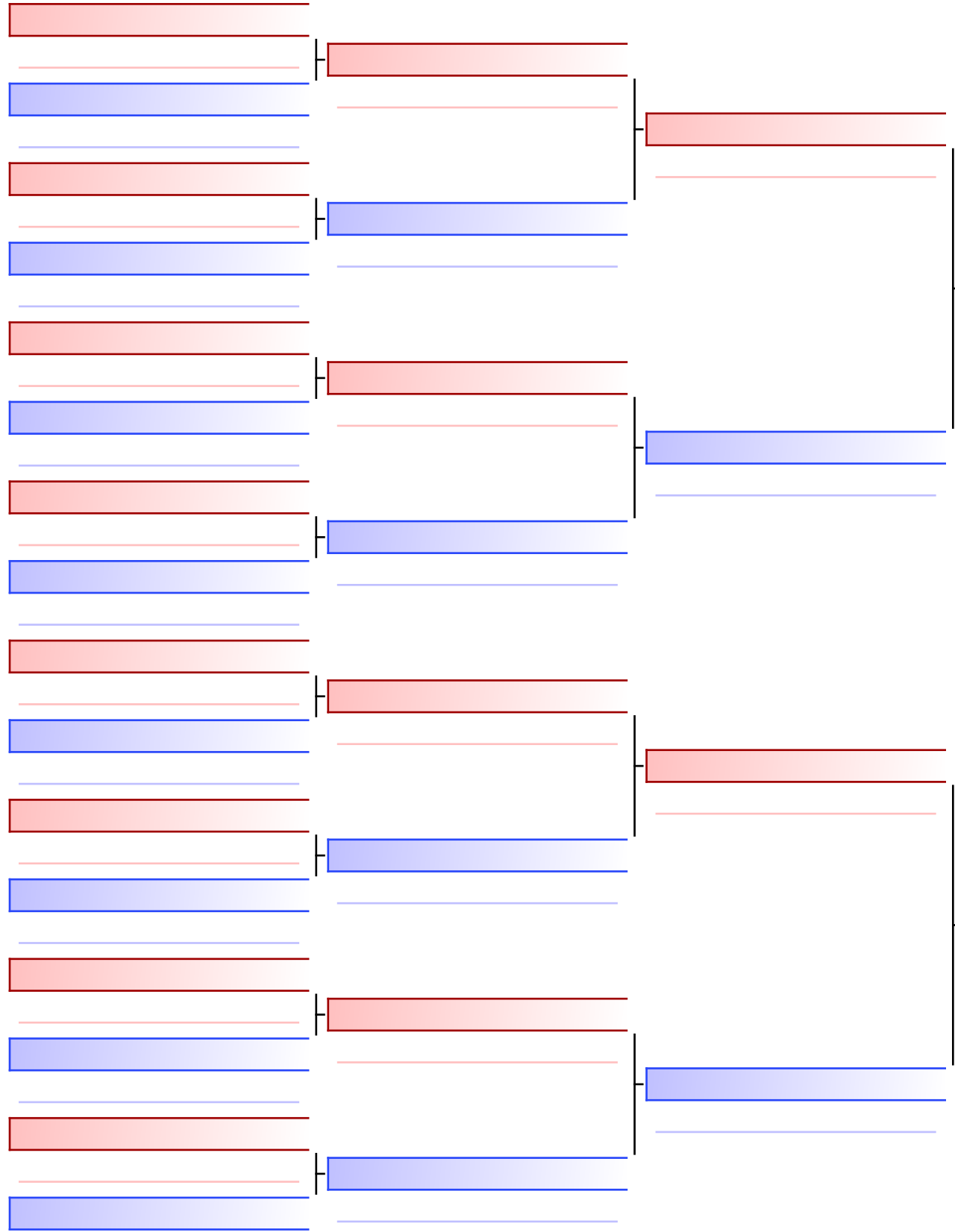

Final

NAJLA SYAKIRA (WADOKAI)  
 4

LOVIA GINDHA\_PUSPITA\_IS (DKI JAKARTA)  
 1

NAJLA SYAKIRA (WADOKAI)



- |   |
|---|
| 1. NAJLA SYAKIRA (WADOKAI)                  |
| 2. LOVIA GINDHA_PUSPITA_IS (DKI JAKARTA)    |
| 3. LUVENA MILANO_SETIYAKA_IN (JAWA TENGAH)  |
| 3. SYEERIN RAMADANI_S_IS (KALIMANTAN TIMUR) |
| 5. ARMY DEWI_PURNAMASARI_IN (BALI)          |
| 5. ARDIANI SITI_FADILLAH (INKANAS)          |
| 7. CITRA ANISA_EDWARD_LK (SUMATERA BARAT)   |
| 7. DENIVALENTIN MANIK (SHOKAIDO)            |

Referees:			

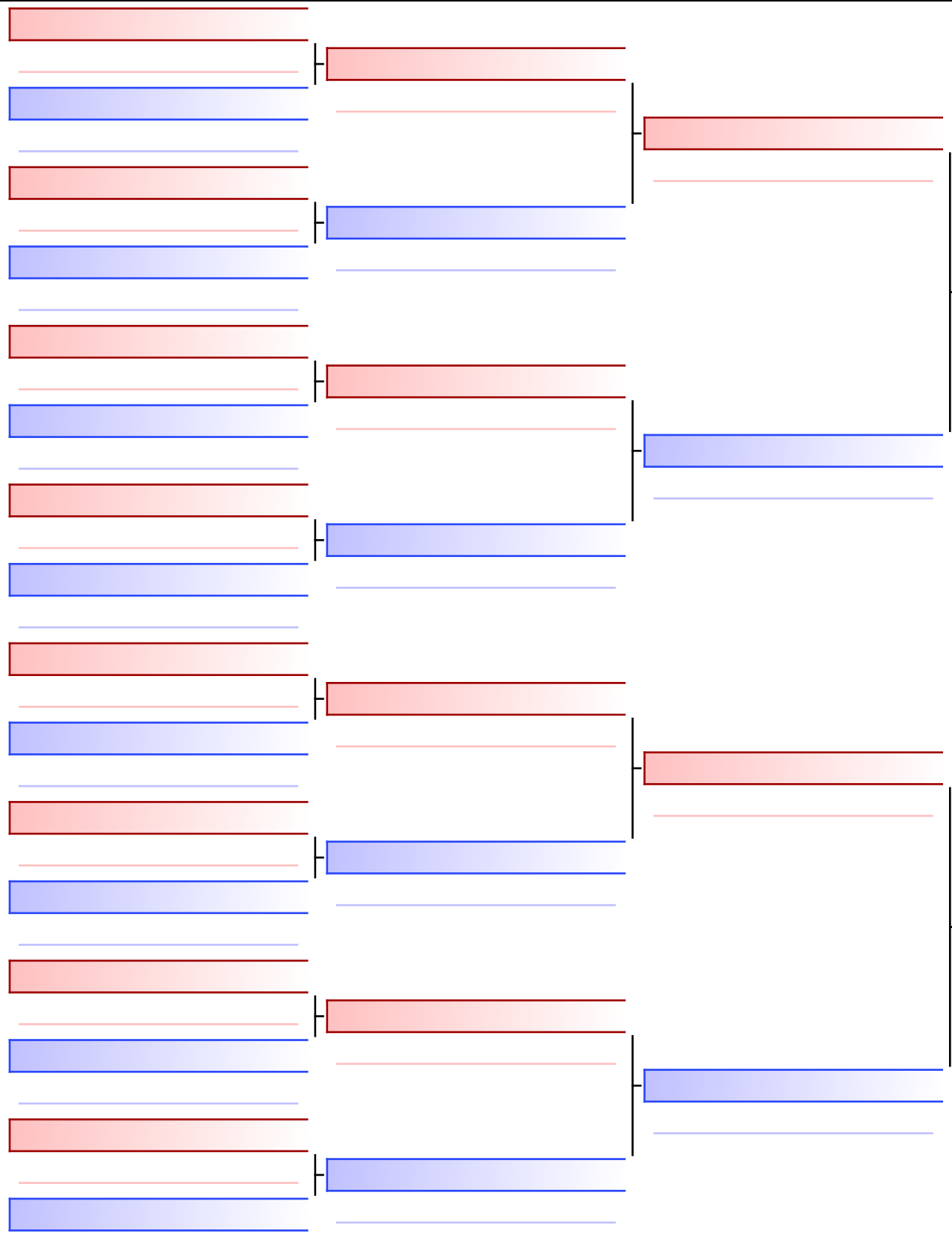

Final

NI MADE\_DWI\_KARTIKA\_APRIANTI\_IN (BALI)

2

ADELIA INDAH\_PERMATA\_SARI\_TUASIKAL (INKADO)

ADELIA INDAH\_PERMATA\_SARI\_TUASIKAL (INKADO)

3

- |  |
|--|
| 1. ADELIA INDAH_PERMATA_SARI_TUASIKAL (INKADO) |
| 2. NI MADE_DWI_KARTIKA_APRIANTI_IN (BALI)      |
| 3. NAJWA SABILA_HABIBIE (INKANAS)              |
| 3. LISYE KASIH_SATIAMU_AS (SULAWESI UTARA)     |
| 5. LUSIANA BRISKIKA (ASKI)                     |
| 5. SALMA AULIA (INKAI)                         |
| 7. RAVENESIA CLAUDIA_TAMBUNAN_IN (DKI JAKARTA) |
| 7. FITRIA MAGITA_NOVA_BC (JAWA BARAT)          |

Referees:			

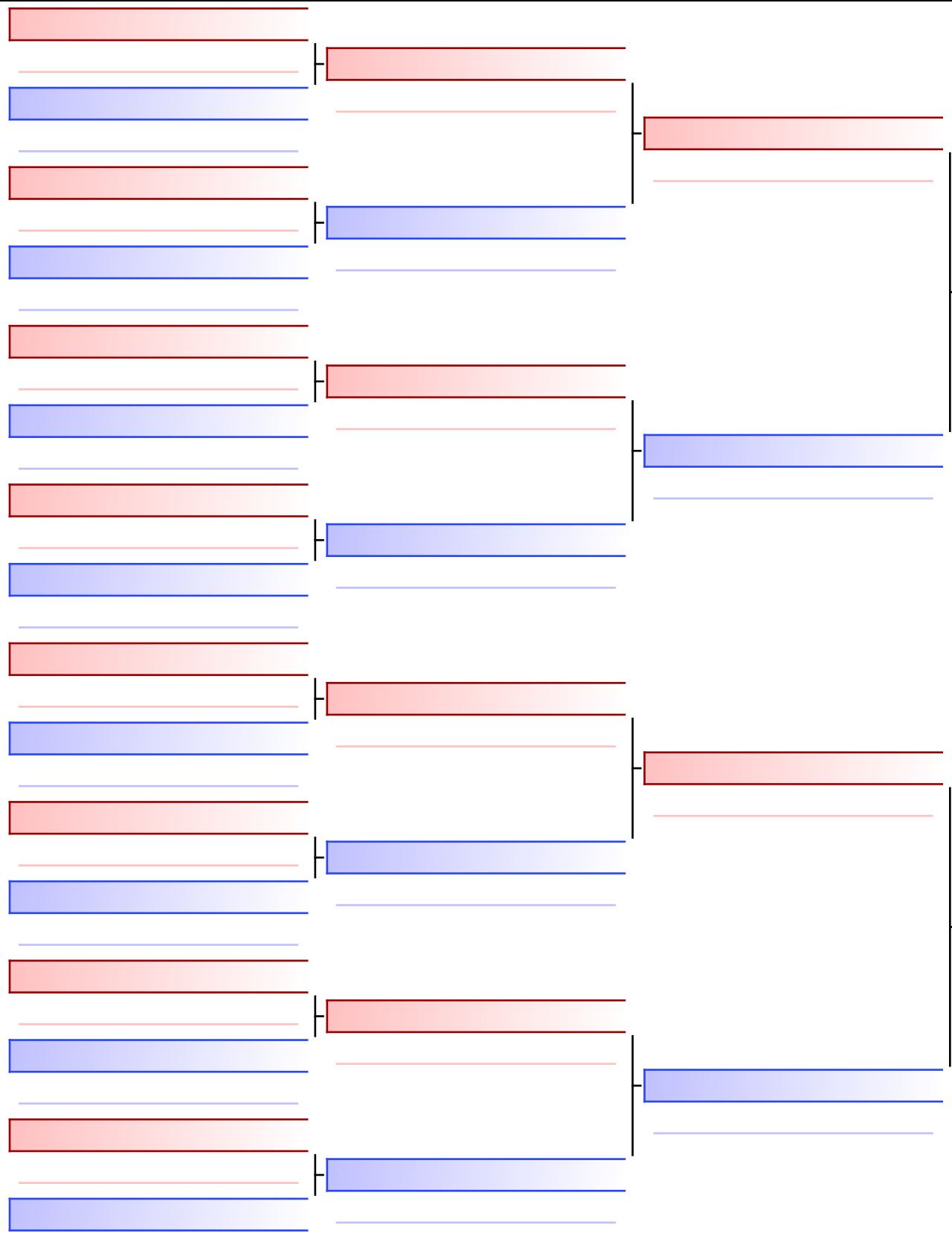

Final

MUHAMMAD PADI\_FAUZAN\_SYAM (KKI)

5

MUHAMMAD PADI\_FAUZAN\_SYAM (KKI)

RACKEE BALARAMA (INKAI)

2



- |   |
|---|
| 1. MUHAMMAD PADI_FAUZAN_SYAM (KKI)          |
| 2. RACKEE BALARAMA (INKAI)                  |
| 3. AQDAS MIFTAHUL_KASFILLAH (INKANAS)       |
| 3. NAUFAL DZAKY_ANSYORI_IS (SUMATERA BARAT) |
| 5. PUJANGGA FITRAH_R_LK (BENGKULU)          |
| 5. WIRA SETYA_YUDHA_SO (RIAU)               |
| 7. KHAID THORIQ_SYAHBANA_IN (JAWA BARAT)    |
| 7. MUHAMMAD FAHRI_BADU_LK (GORONTALO)       |

Referees:			

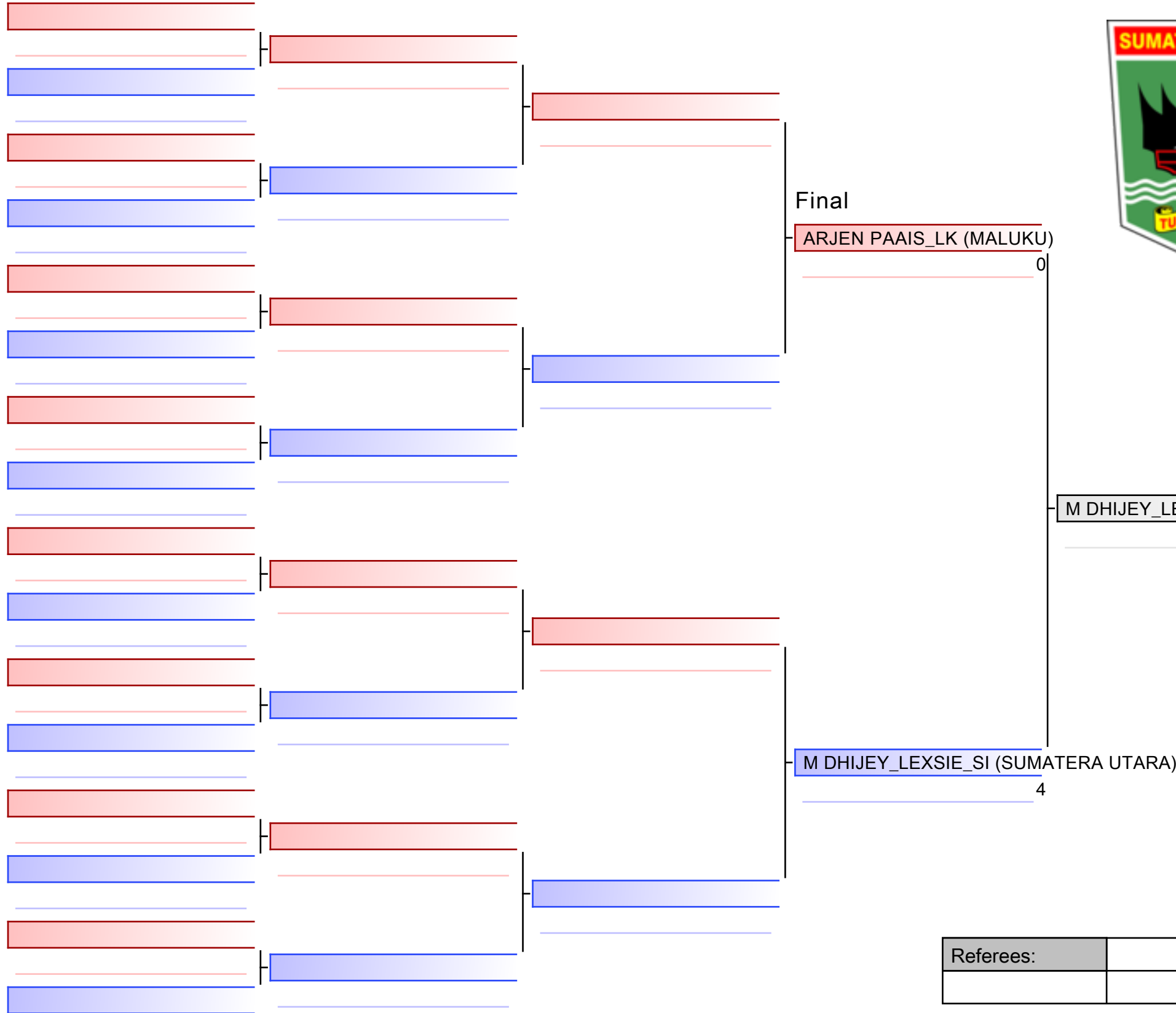

M DHIJEY\_LEXSIE\_SI (SUMATERA UTARA)

- |   |
|---|
| 1. M DHIJEY_LEXSIE_SI (SUMATERA UTARA)  |
| 2. ARJEN PAAIS_LK (MALUKU)              |
| 3. MADE RYAN_ADITYA_JAYA (KKI)          |
| 3. TIO TRIRALY_SAMBENTIRO (WADOKAI)     |
| 5. GALANG RIZKI_IS (NTB)                |
| 5. TAZKYA PUTRA_MASHUDI-IS (JAWA BARAT) |
| 7. ABDUL HAFIZ_AGIL_FIRDAUS (ASKI)      |
| 7. KOMANG TRI_WIDHIARDIKA (LEMKARI)     |

Referees:			

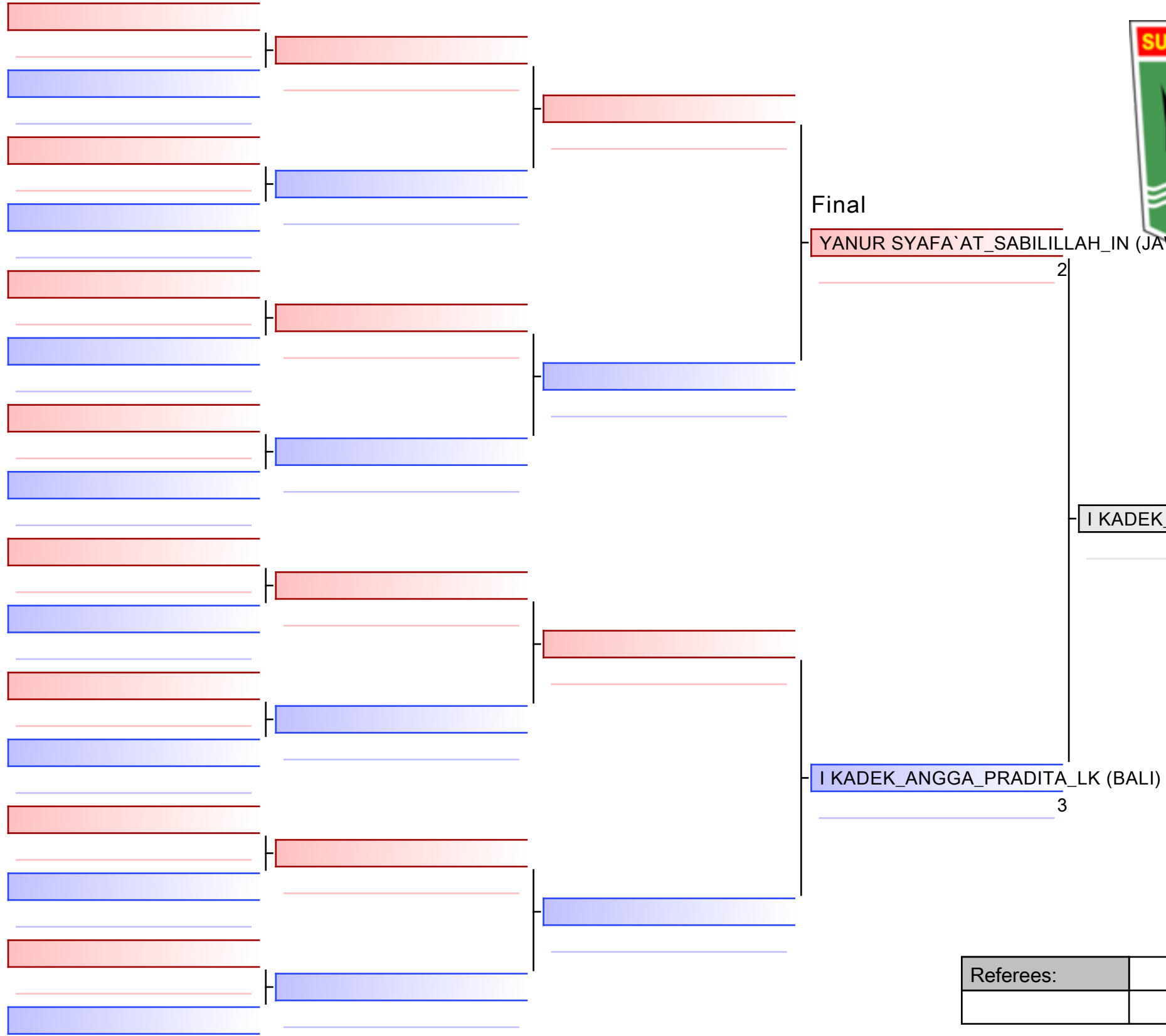

- |  |
|--|
| 1. I KADEK_ANGGA_PRADITA_LK (BALI)           |
| 2. YANUR SYAFA`AT_SABILILLAH_IN (JAWA TIMUR) |
| 3. FAHREL APRIANSYAH_AMARTHA_KI (LAMPUNG)    |
| 3. AURIGA ARYASATYA_MULYANTO_AS (JAWA TIMUR) |
| 5. RAJA MUHAMMAD_ZAKI_IS (SUMATERA BARAT)    |
| 5. SATRYO ARYA_PUTRA (INKAI)                 |
| 7. M LANTANG_DINANBANA_LUTHAN (GOJUKAI)      |
| 7. SOFYAN HAFIFI_IS (NTB)                    |

Referees:			



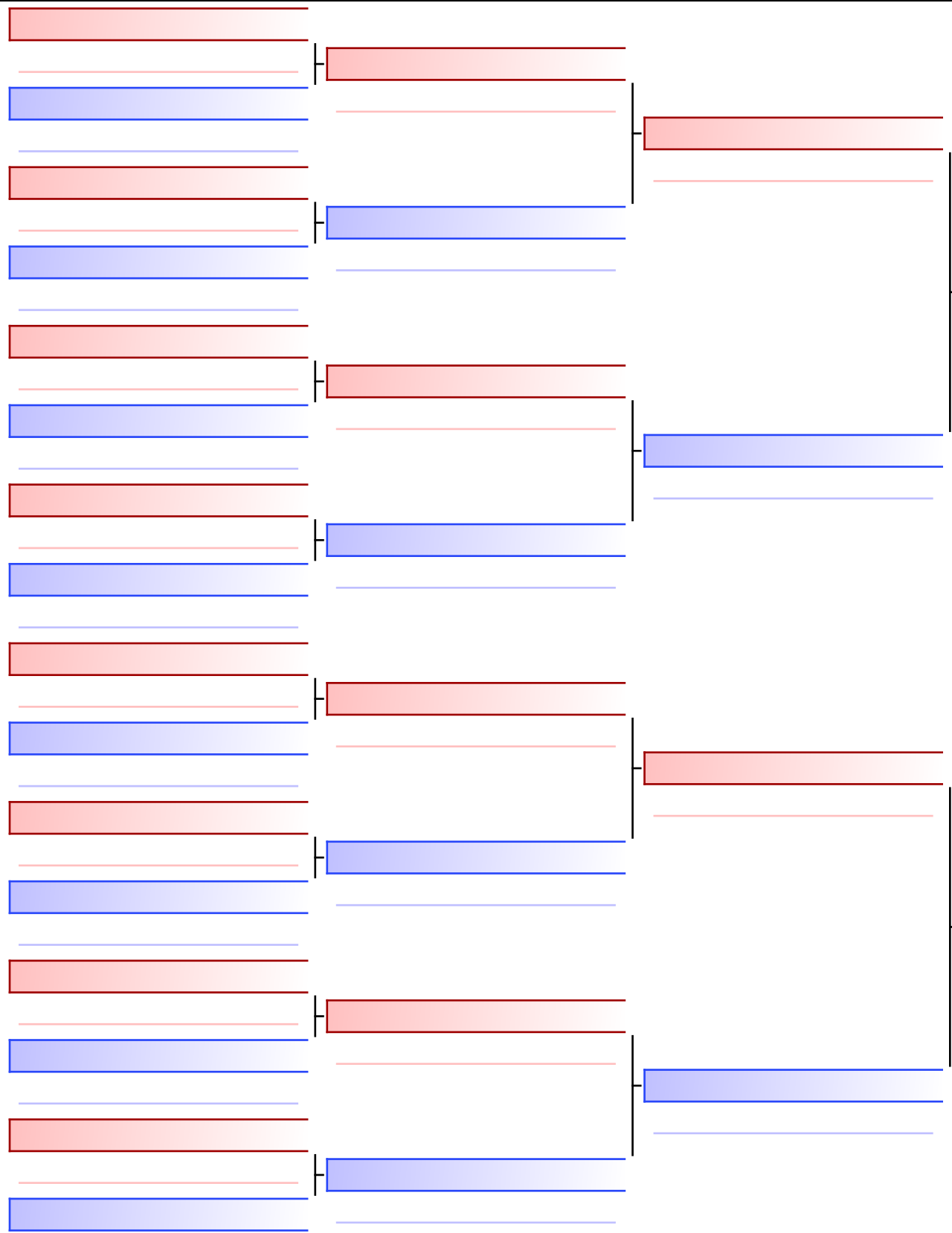

Final

MOCHAMMAD FEBRILYANSYAH\_LK (JAWA BARAT)

1

DINO BAGUS\_ARYO\_SETO (LEMKARI)

DINO BAGUS\_ARYO\_SETO (LEMKARI)

2

- 1. DINO BAGUS\_ARYO\_SETO (LEMKARI)
- 2. MOCHAMMAD FEBRILYANSYAH\_LK (JAWA BARAT)
- 3. FAREL ARAFI\_HILMANSYAH\_LK (SUMATERA UTARA)
- 3. MUHAMMAD LEO\_PUTRA\_IN (DKI JAKARTA)
- 5. GREY NIDAN\_KALKA\_AIRU\_LK (LAMPUNG)
- 5. GILANG ALYA\_SYAHPUTRA\_LK (SUMATERA BARAT)
- 7. MUHAMMAD BINTANG\_SALVATORE\_IN (JAWA BARAT)
- 7. INDRA MANASSEY\_NAPITUPULU (KEI SHIN KAWAN)

Referees:			

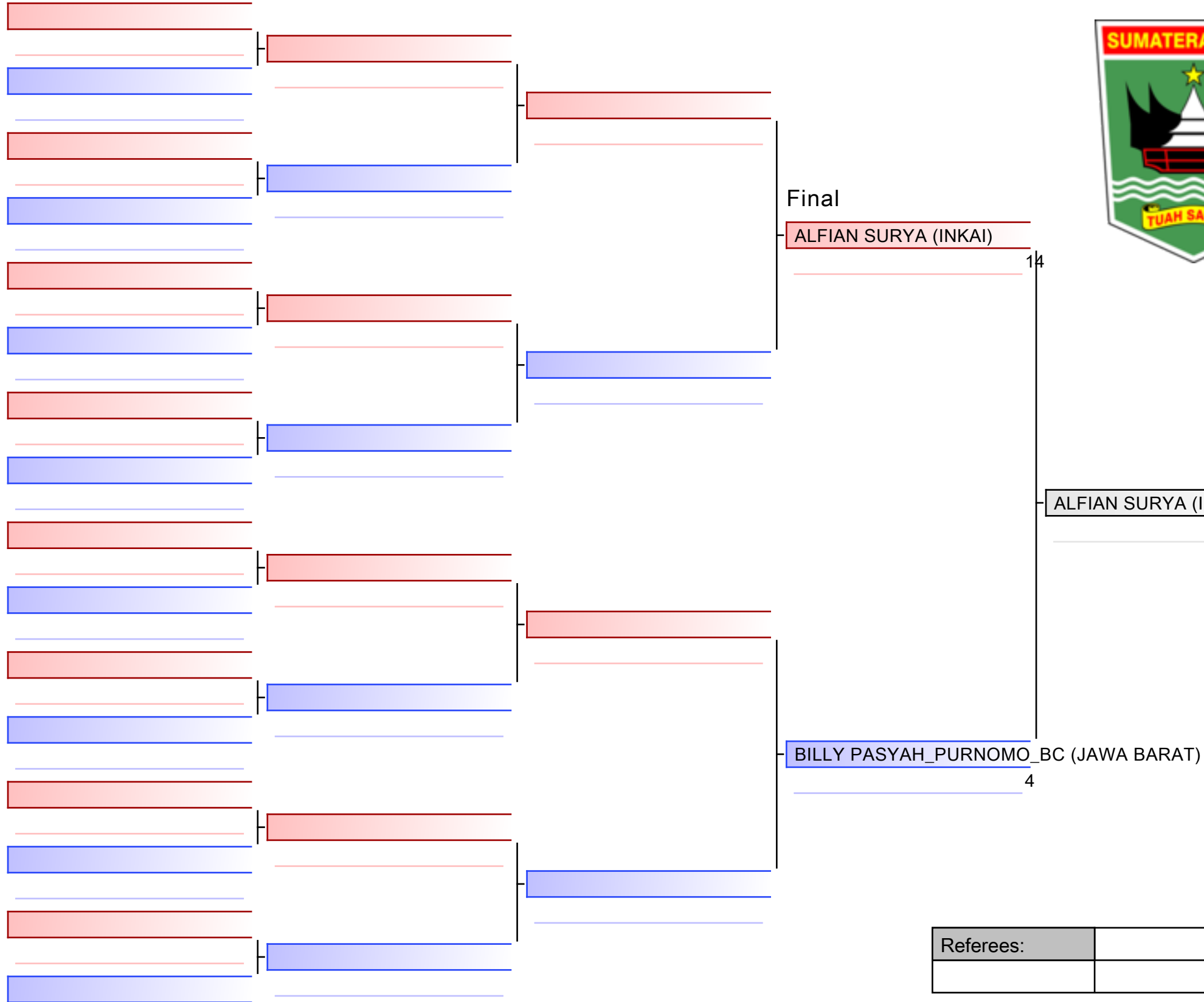

ALFIAN SURYA (INKAI)

- |   |
|---|
| 1. ALFIAN SURYA (INKAI)                 |
| 2. BILLY PASYAH_PURNOMO_BC (JAWA BARAT) |
| 3. RAIHANI IRFANDA (LEMKARI)            |
| 3. YOHANES RADO_SUMANIK (BKC)           |
| 5. RIFFAT JUHLANSYAH_SOBARI (KKI)       |
| 5. GEMA AWAL_RAMADHAN_IS (SUMATERA BAR) |
| 7. WINTAMA DIMAS_FIQIH_KI (LAMPUNG)     |
| 7. LUKMANUL HAKIM_IN (SUMATERA UTARA)   |

Referees:			

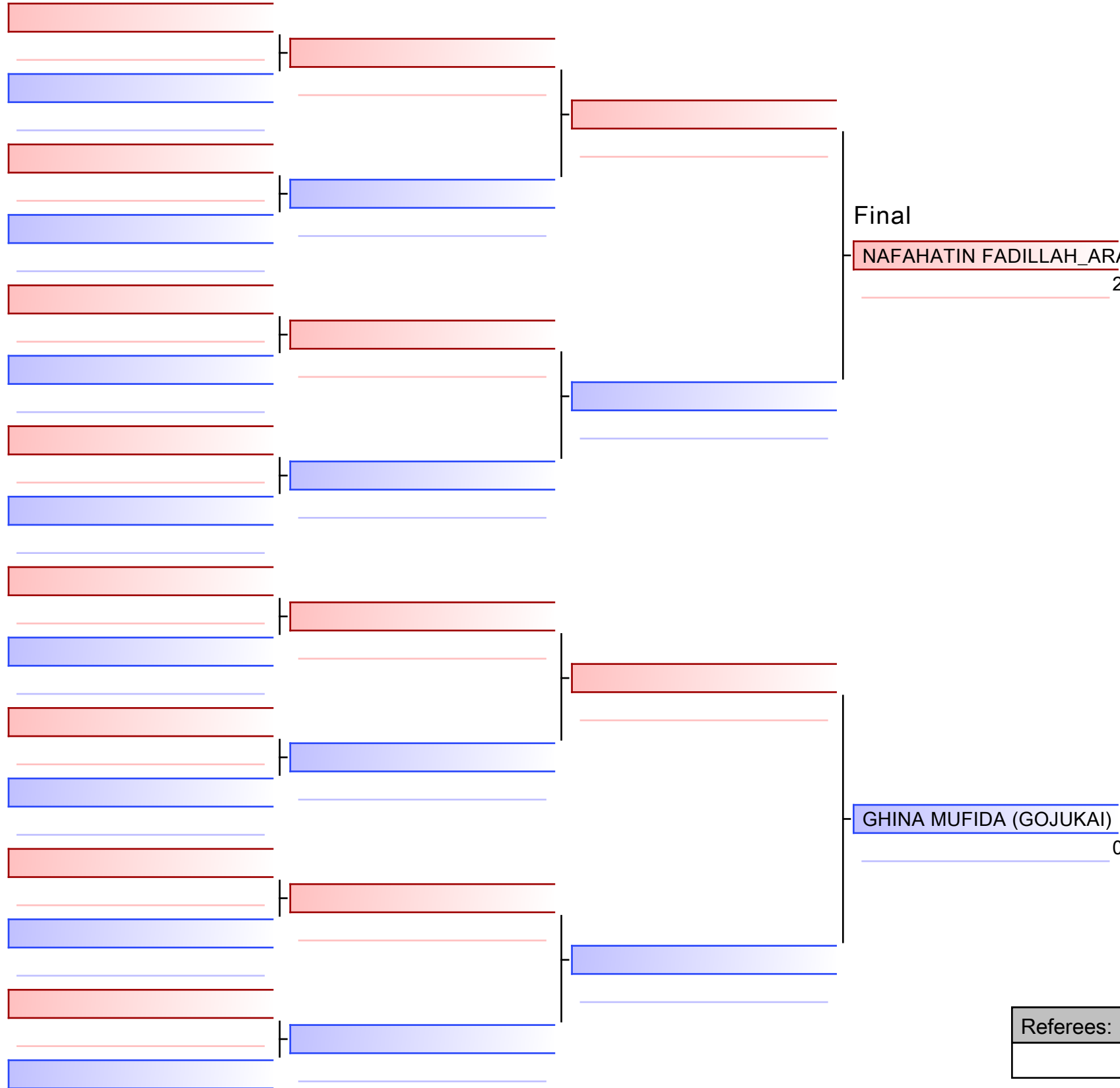

NAFAHATIN FADILLAH\_ARAFAT (LEMKARI)

- |   |
|---|
| 1. NAFHATIN FADILLAH_ARAFAT (LEMKARI)     |
| 2. GHINA MUFIDA (GOJUKAI)                 |
| 3. RAHMATIKA DWI_WAHYUNINGRUM (INKAI)     |
| 3. FAKHRIYYAH HAMID (KKI)                 |
| 5. ALODYA VARISSA_KHAWISWARA_BC (JAWA T)  |
| 5. ZENY KAYLA_NATHANIA_AS (JAWA BARAT)    |
| 7. KURNIA PUTRI_IVANA_IS (SUMATERA BARAT) |
| 7. RINDI ZIA_NAJLA (ASKI)                 |

Referees:			

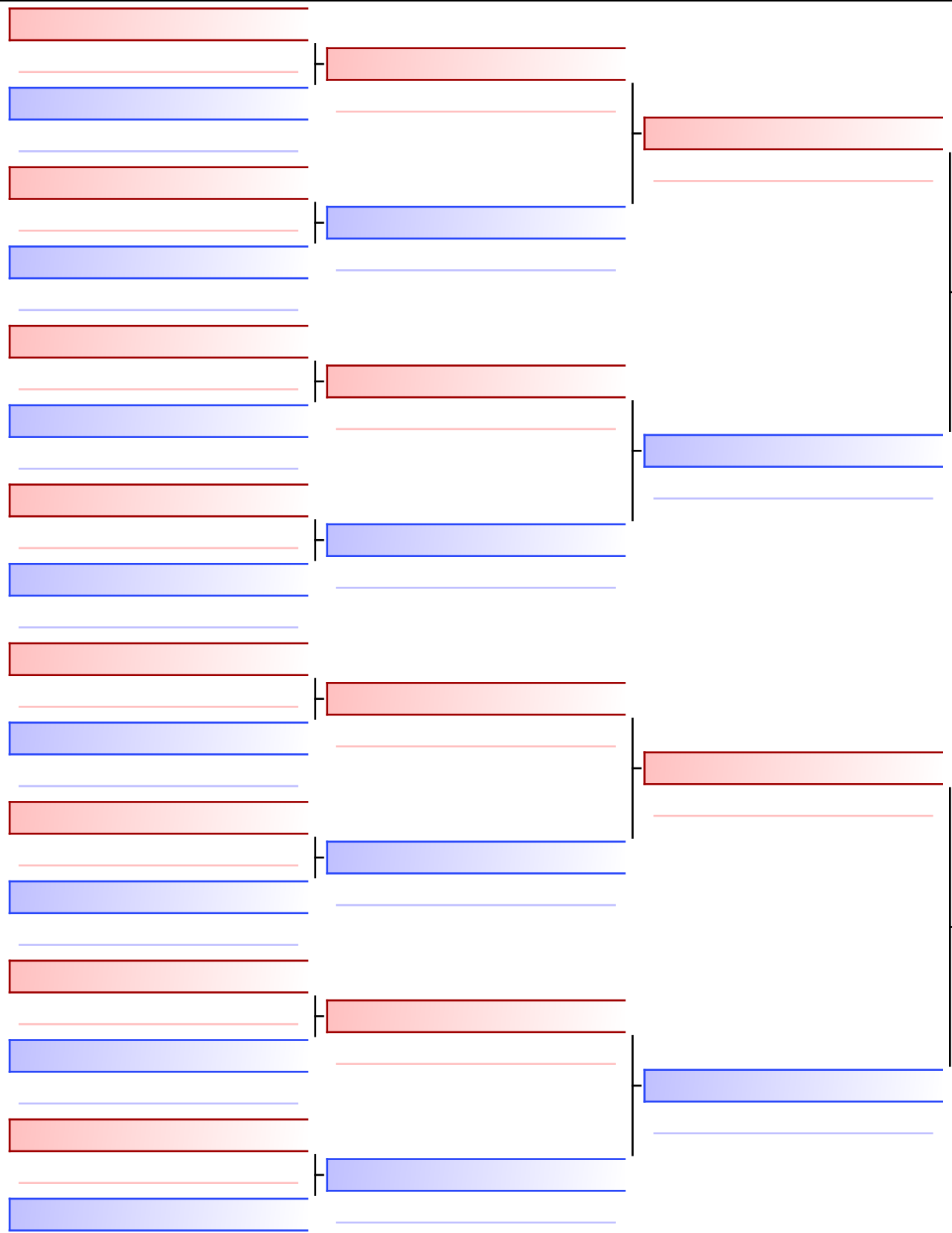

Final

FAYYAZA LAIQHA\_ZAHLULA\_IN (DKI JAKARTA)

5

FAYYAZA LAIQHA\_ZAHLULA\_IN (DKI JAKARTA)

KIRANA ANISA-BC (JAWA BARAT)

2



- |  |
|--|
| 1. FAYYAZA LAIQHA_ZAHLULA_IN (DKI JAKARTA) |
| 2. KIRANA ANISA-BC (JAWA BARAT)            |
| 3. SALWA ALYA_ERSATAMA (ASKI)              |
| 3. SYIFA SALSABILA (WADOKAI)               |
| 5. RAISSA DEWI_ANDINI_IS (KEPULAUAN RIAU)  |
| 5. CAHAYA KI (SUMATERA SELATAN)            |
| 7. MUTIARA REVA (BUDOKAI)                  |
| 7. DEDES PITRIYAH (INKAI)                  |

Referees:			

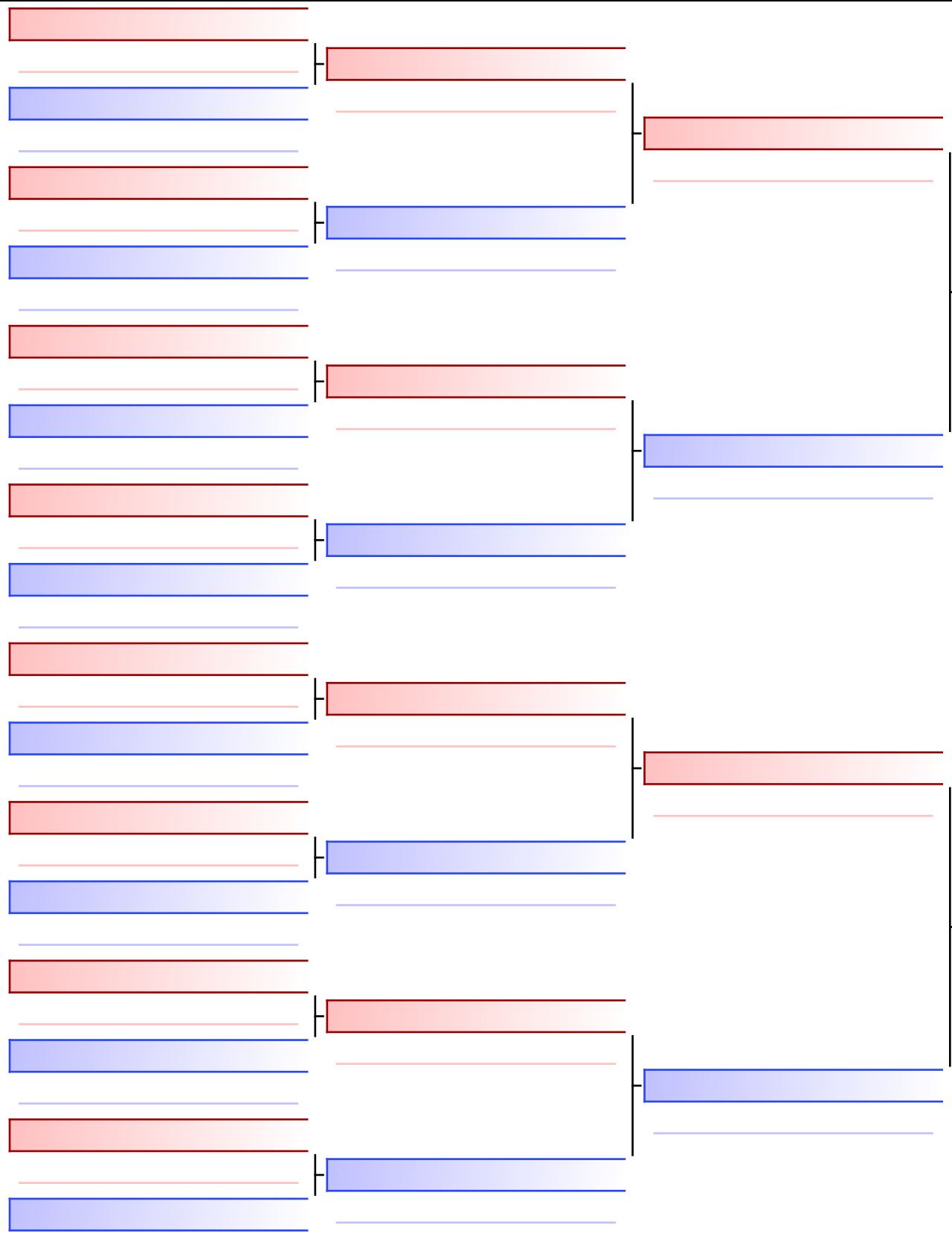

Final

ERINE BRYTHANIA\_AURORA\_POTOROLI\_IN (SULAWESI UTARA)

4

ERINE BRYTHANIA\_AURORA\_POTOROLI\_IN (SULAWESI UTARA)

NADHYA IS (JAWA BARAT)

1



- |   |
|---|
| 1. ERINE BRYTHANIA_AURORA_POTOROLI_IN (S) |
| 2. NADHYA IS (JAWA BARAT)                 |
| 3. AINI CITRA_DEVI (INKANAS)              |
| 3. LUTHFIA ALINI_KI (ACEH)                |
| 5. NABILA ALYA_LUTFIANA_IN (JAWA TIMUR)   |
| 5. ANJIRA KI (SUMATERA UTARA)             |
| 7. NURUL SANDIKA_IN (KALIMANTAN TIMUR)    |
| 7. RENATA DWINANDA_ZARRA_ID (SUMATERA B)  |

Referees:			

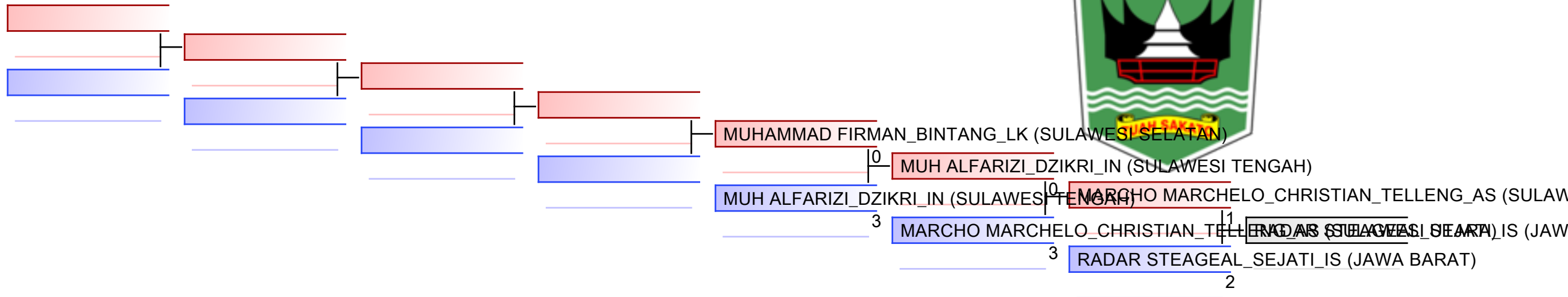

REPECHAGE: (2)

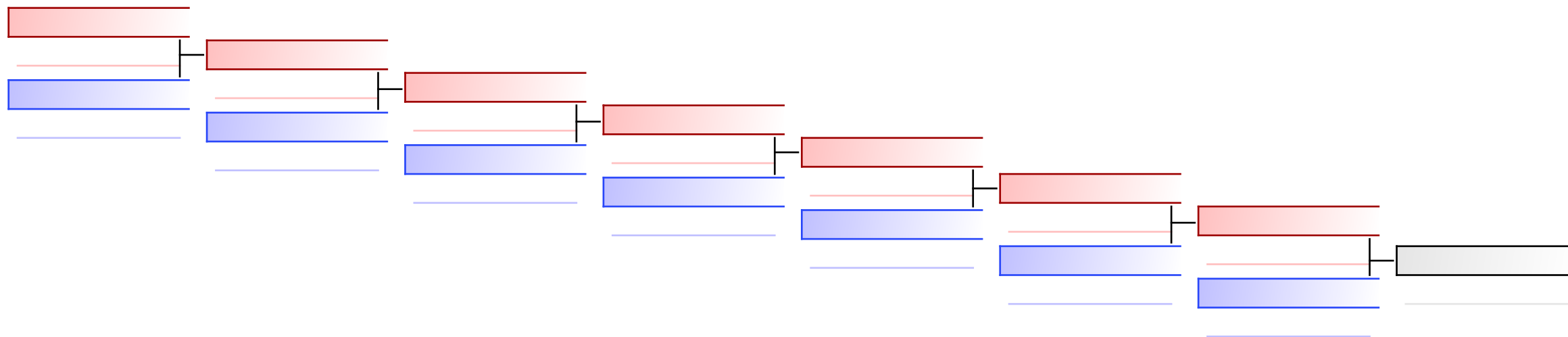

Referees:							
-----------	--	--	--	--	--	--	--

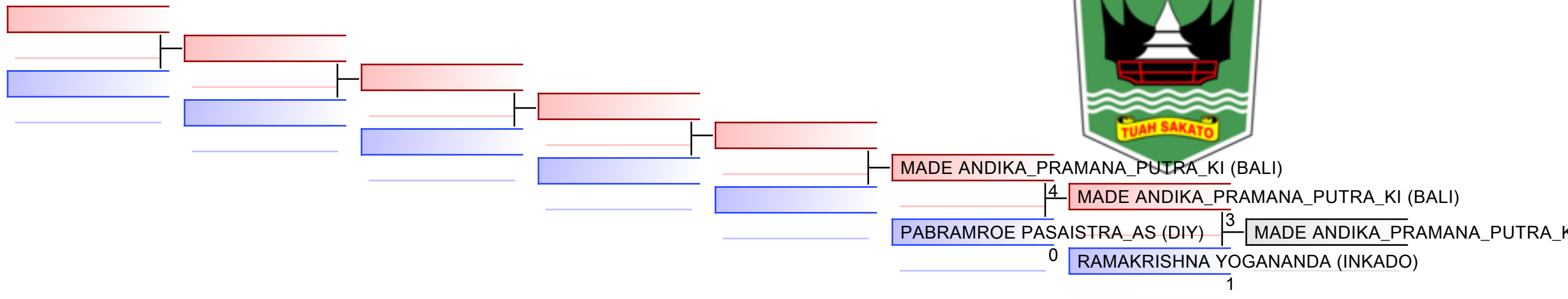

REPECHAGE: (1)

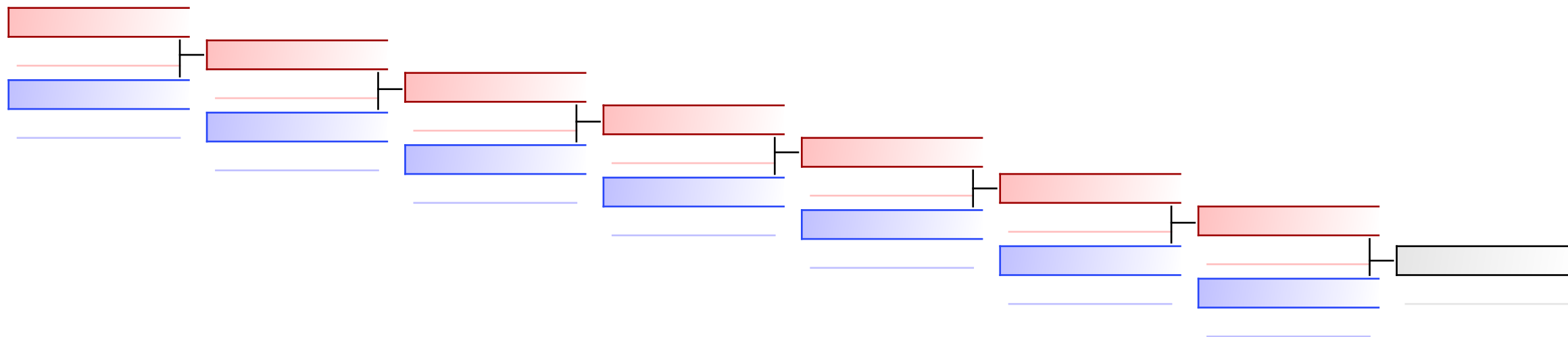

Referees:							
-----------	--	--	--	--	--	--	--



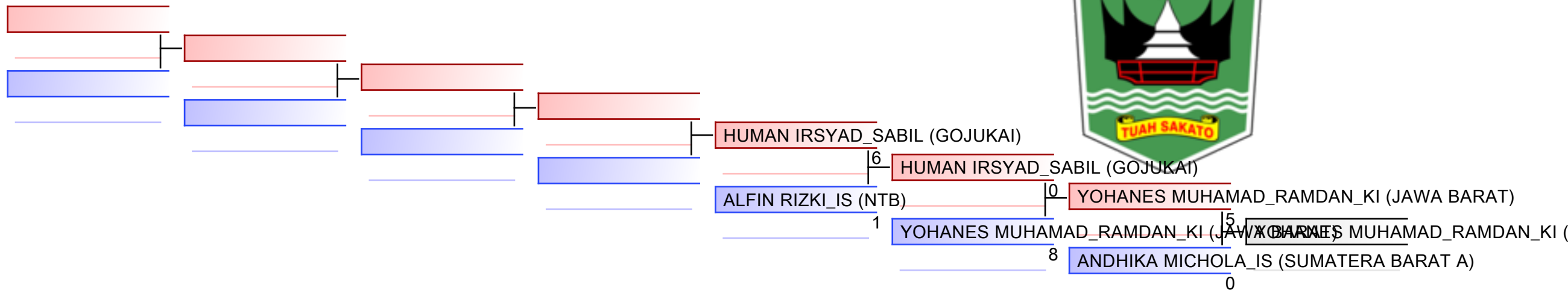

REPECHAGE: (2)

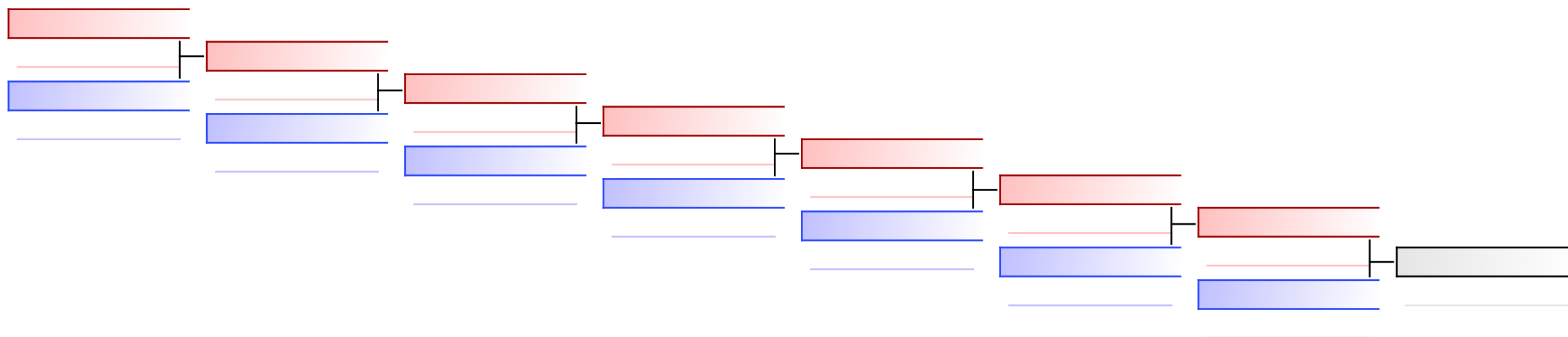

Referees:							
-----------	--	--	--	--	--	--	--

# JUNIOR KUMITE PUTRA -55 KG

KEJUARAAN NASIONAL KARATE PIALA KETUA UMUM PB FORKI TAHUN 2022

(c)sportdata GmbH & Co KG 2000-2022 (2022-10-04 22:28) v 9.9.0 build 1 (2022-08-12) License: PB FORKI INA (expire 2023-07-04)

2022-10-04

Tatami  
1 19:15

Pool  
1

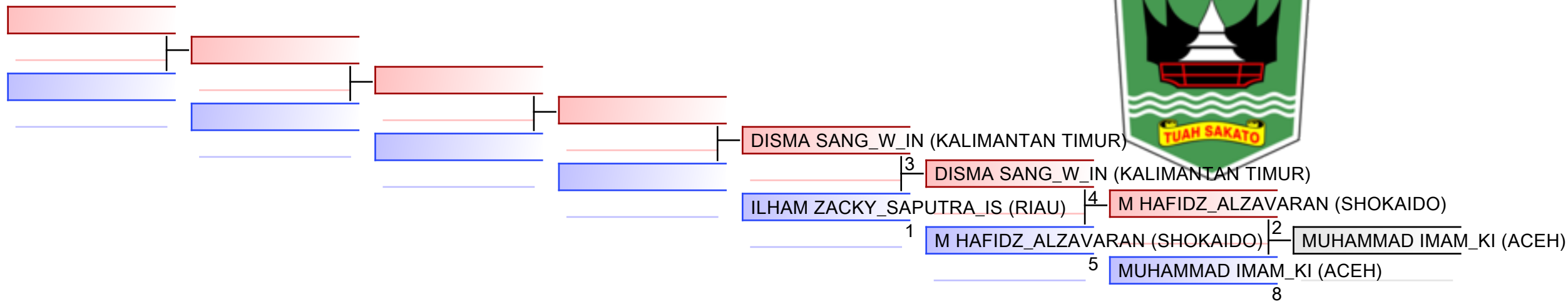

## REPECHAGE: (1)

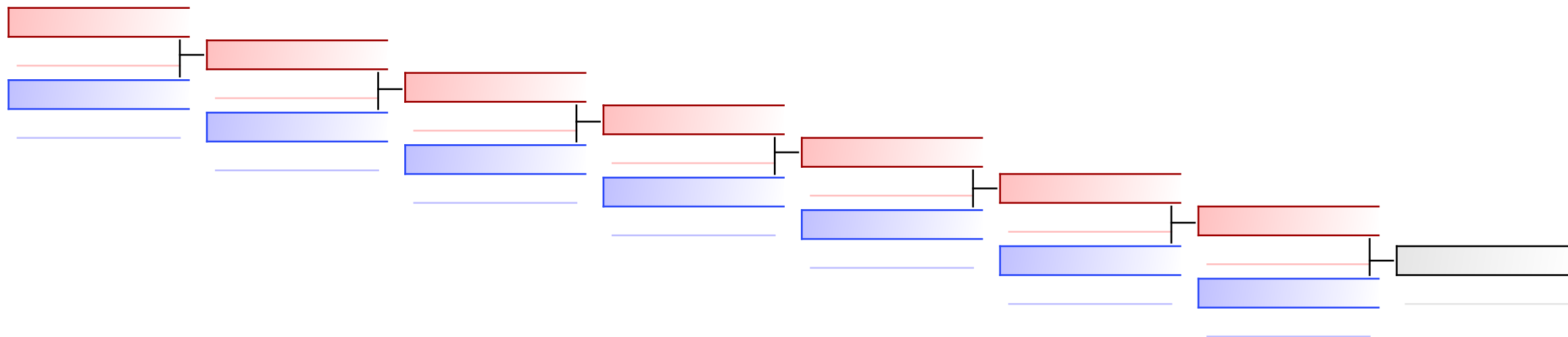

Referees:							
-----------	--	--	--	--	--	--	--

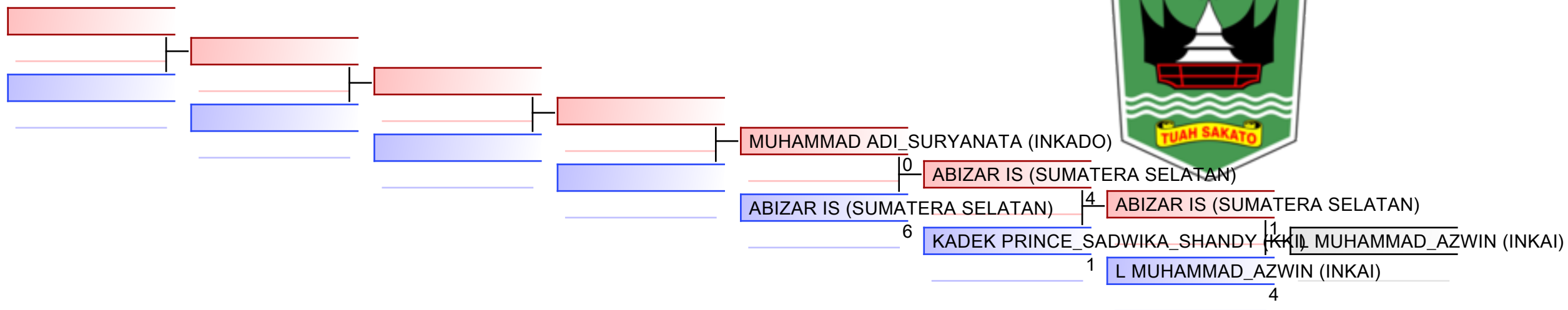

REPECHAGE: (1)

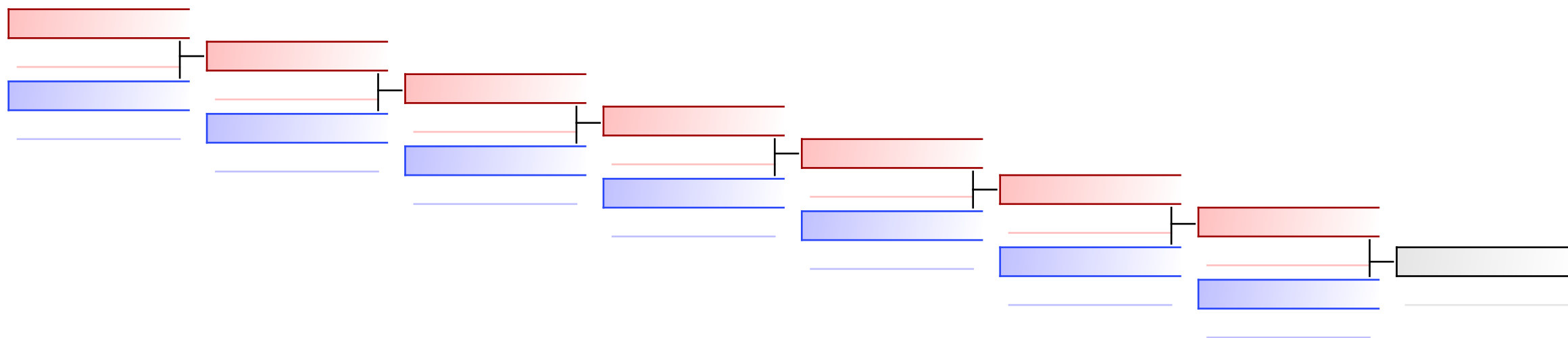

Referees:							
-----------	--	--	--	--	--	--	--

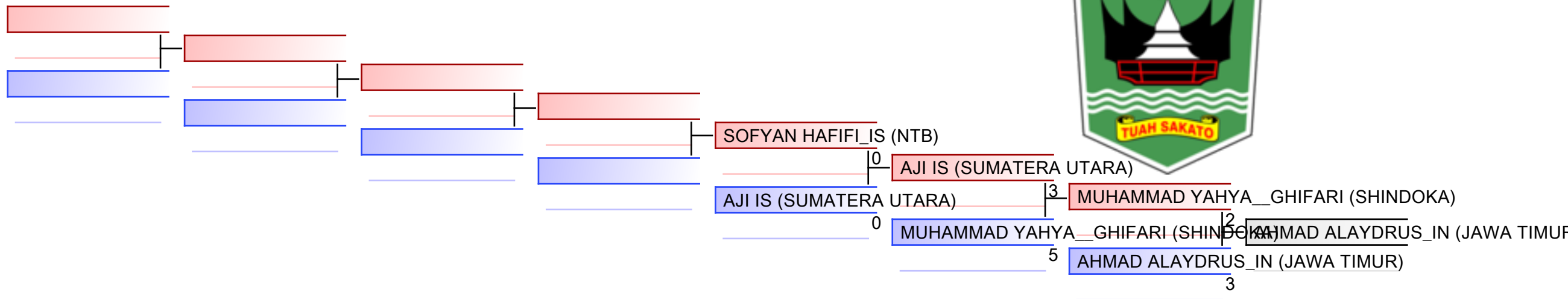

REPECHAGE: (2)

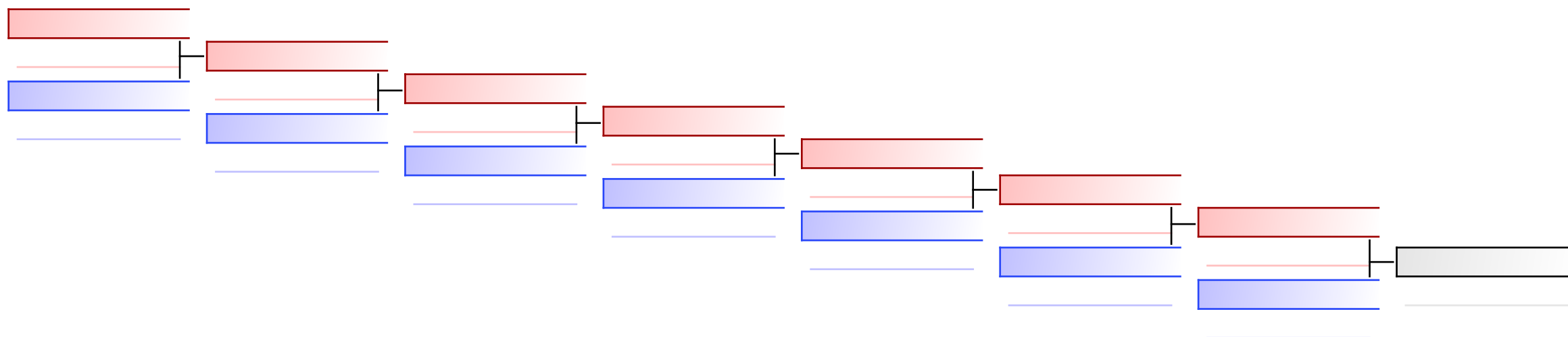

Referees:							
-----------	--	--	--	--	--	--	--

# JUNIOR KUMITE PUTRA -68 KG

KEJUARAAN NASIONAL KARATE PIALA KETUA UMUM PB FORKI TAHUN 2022

(c)sportdata GmbH & Co KG 2000-2022 (2022-10-04 22:28) v 9.9.0 build 1 (2022-08-12) License: PB FORKI INA (expire 2023-07-04)

2022-10-04

Tatami  
2 16:30

Pool  
2

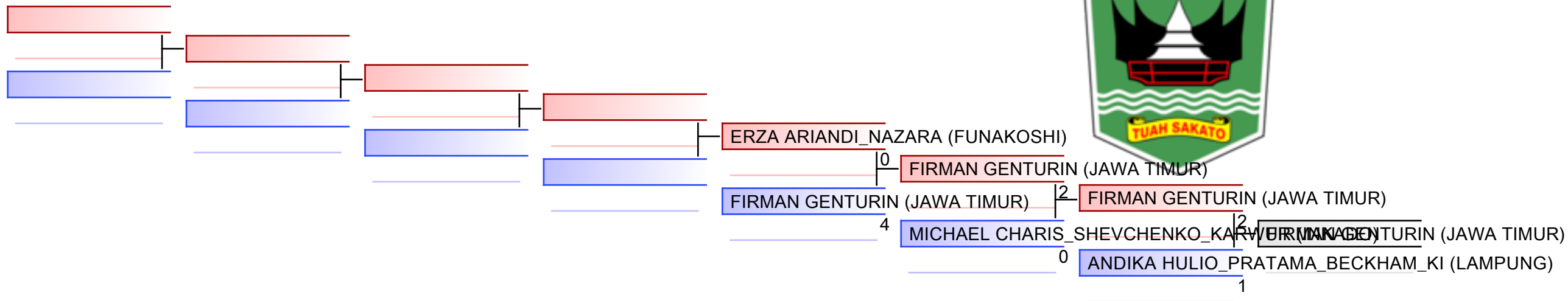

## REPECHAGE: (2)

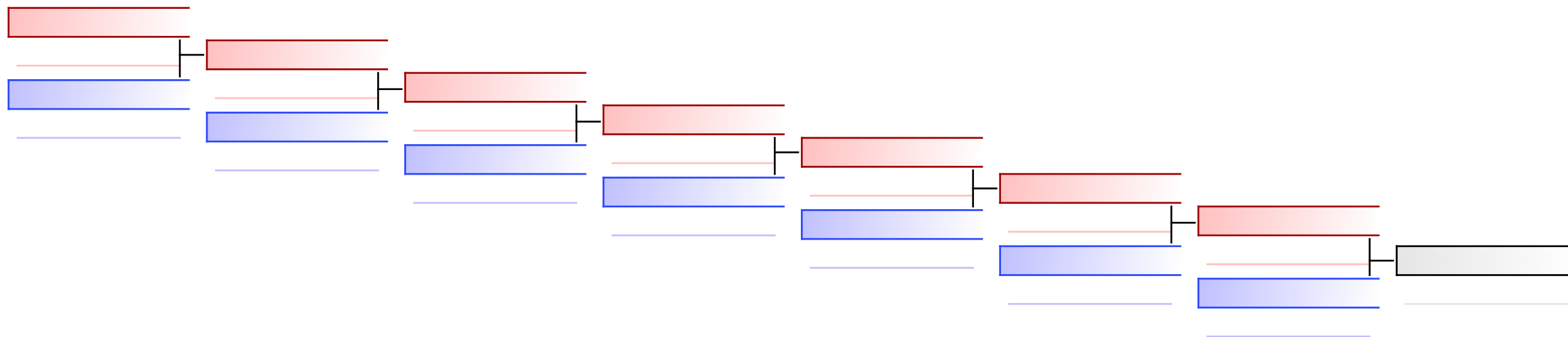

Referees:							
-----------	--	--	--	--	--	--	--

# JUNIOR KUMITE PUTRA -68 KG

KEJUARAAN NASIONAL KARATE PIALA KETUA UMUM PB FORKI TAHUN 2022

(c)sportdata GmbH & Co KG 2000-2022 (2022-10-04 22:28) v 9.9.0 build 1 (2022-08-12) License: PB FORKI INA (expire 2023-07-04)

2022-10-04

Tatami  
1 16:30

Pool  
1

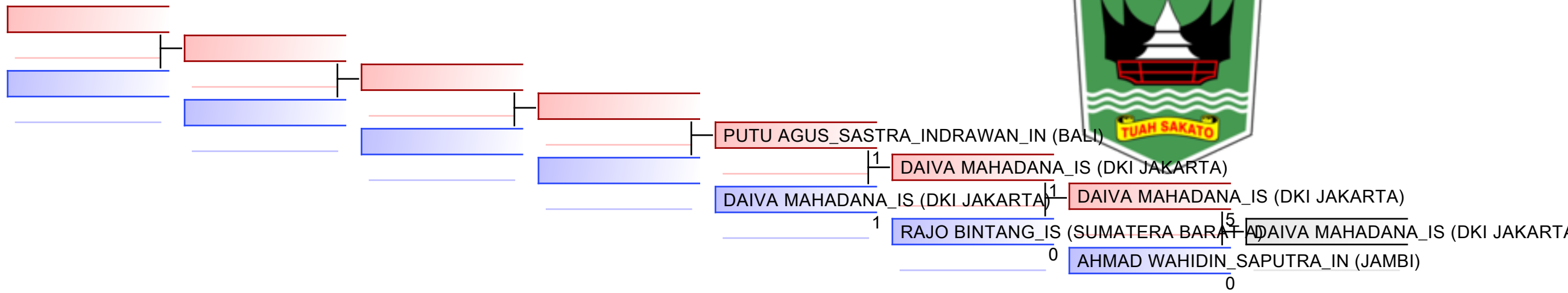

## REPECHAGE: (1)

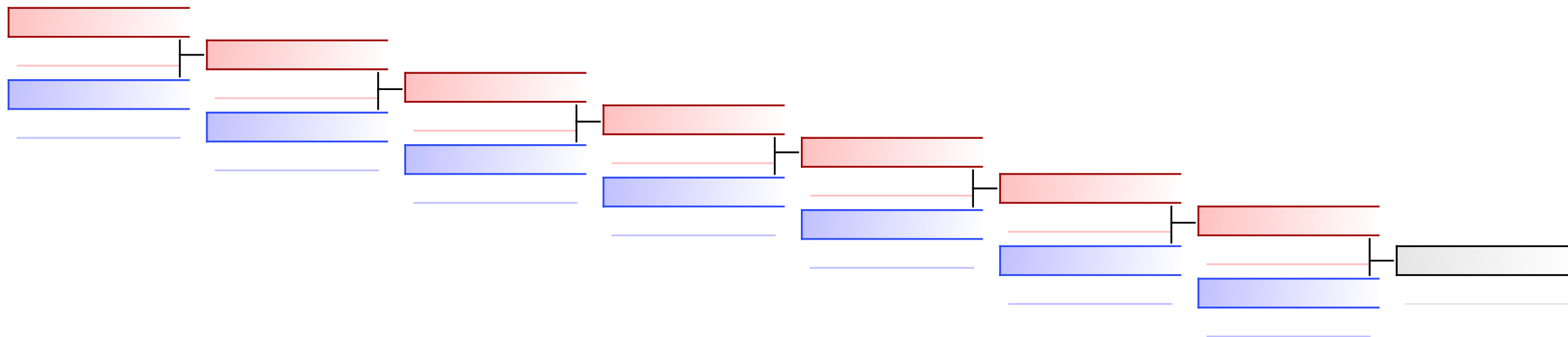

Referees:							
-----------	--	--	--	--	--	--	--

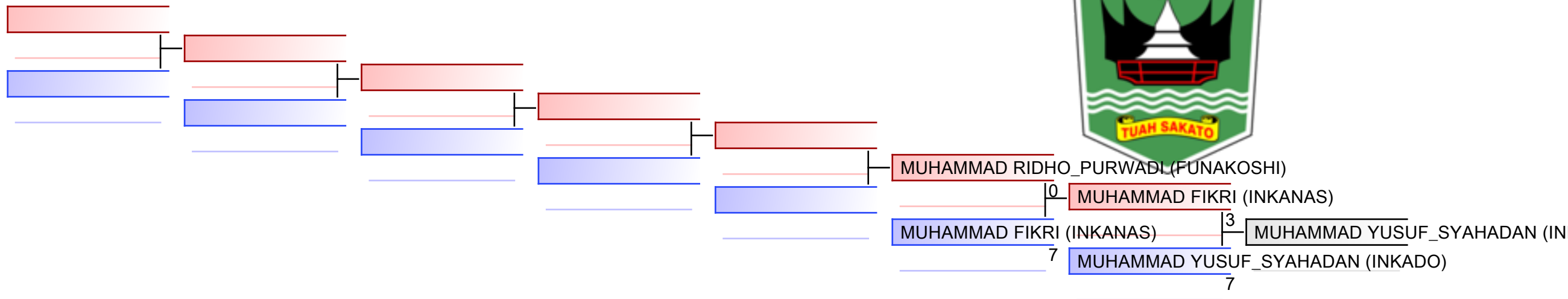

REPECHAGE: (2)

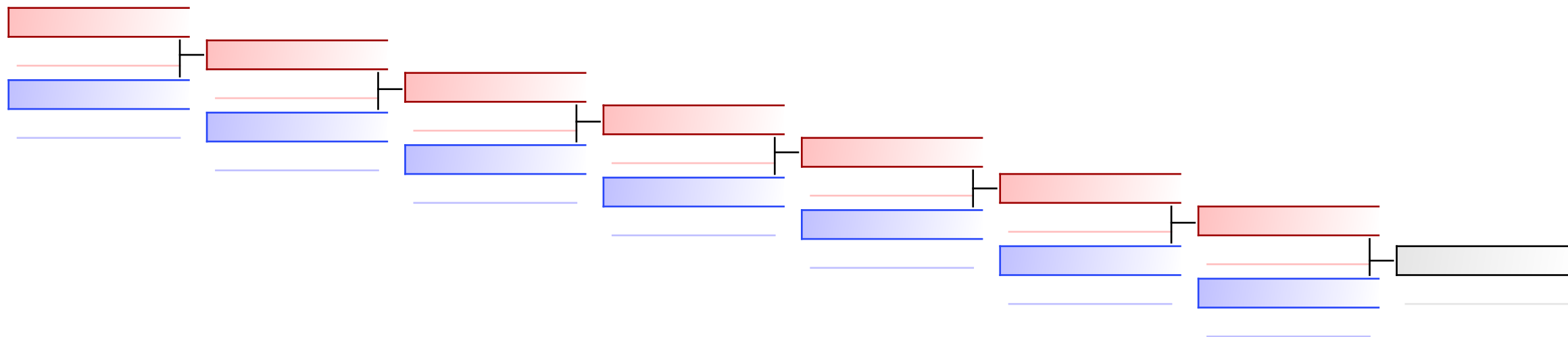

Referees:							
-----------	--	--	--	--	--	--	--



# JUNIOR KUMITE PUTRA -76 KG

KEJUARAAN NASIONAL KARATE PIALA KETUA UMUM PB FORKI TAHUN 2022

2022-10-04

Tatami  
3 15:50

Pool  
1

(c)sportdata GmbH & Co KG 2000-2022 (2022-10-04 22:28) v 9.9.0 build 1 (2022-08-12) License: PB FORKI INA (expire 2023-07-04)

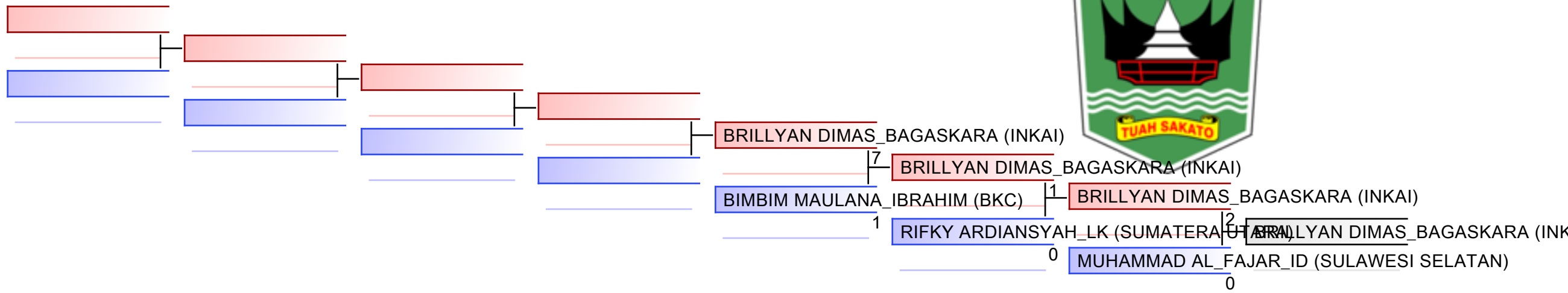

## REPECHAGE: (1)

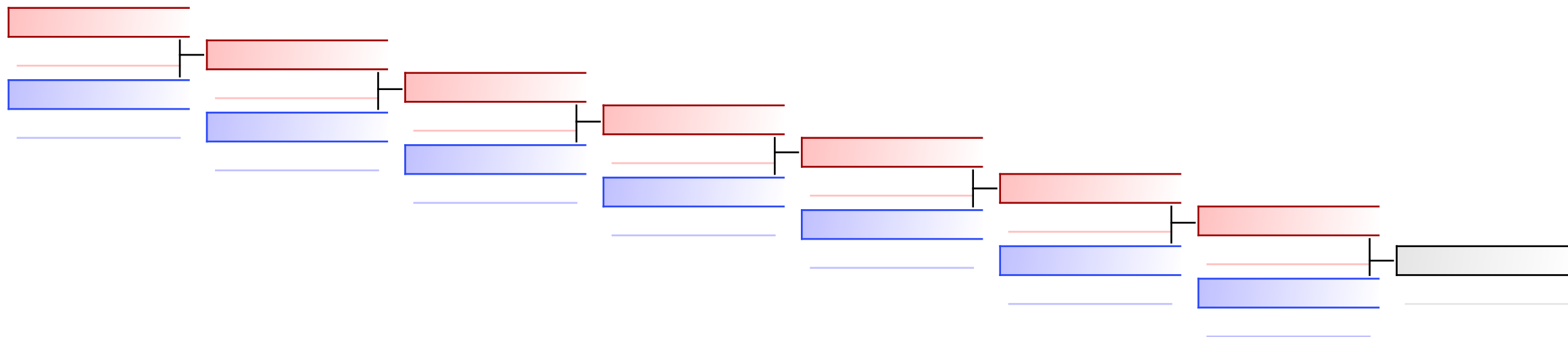

Referees:							
-----------	--	--	--	--	--	--	--

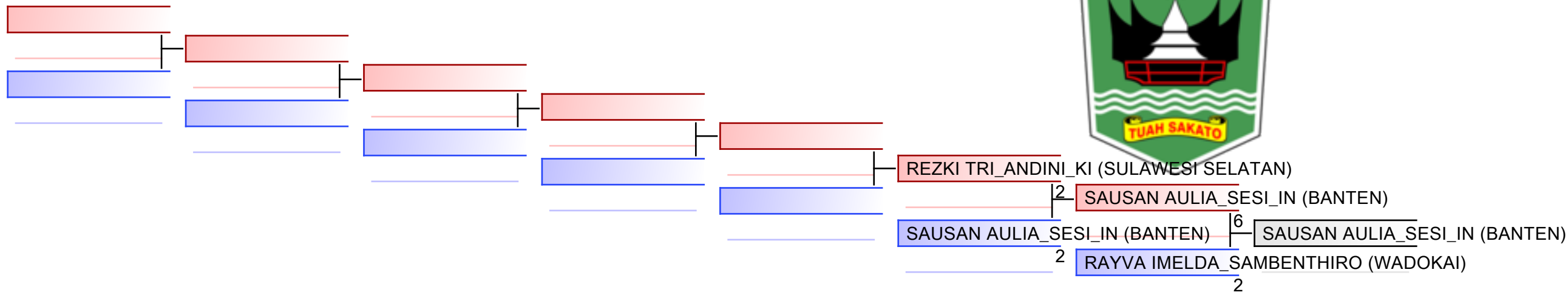

REPECHAGE: (1)

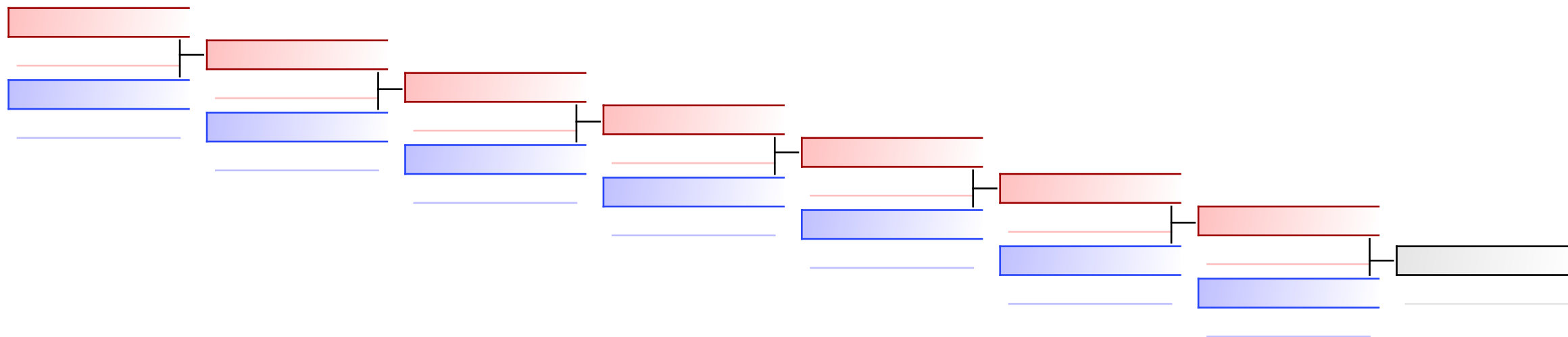

Referees:							
-----------	--	--	--	--	--	--	--

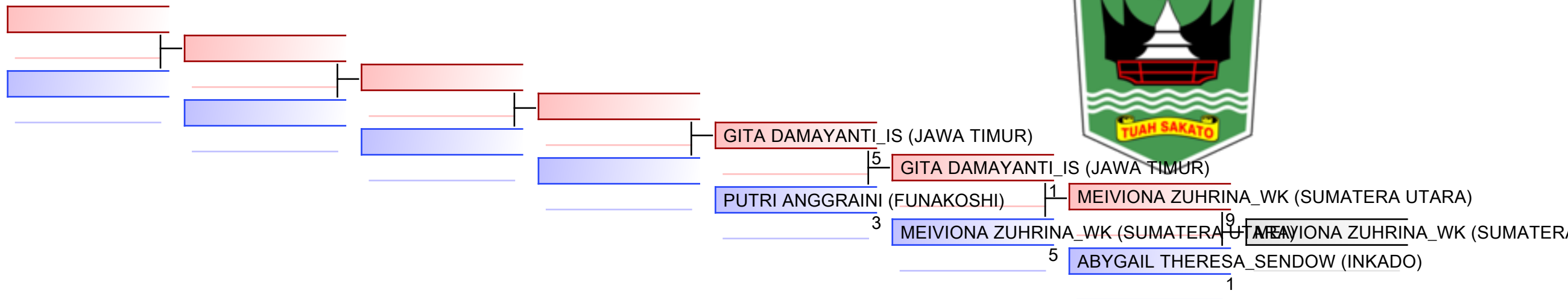

REPECHAGE: (2)

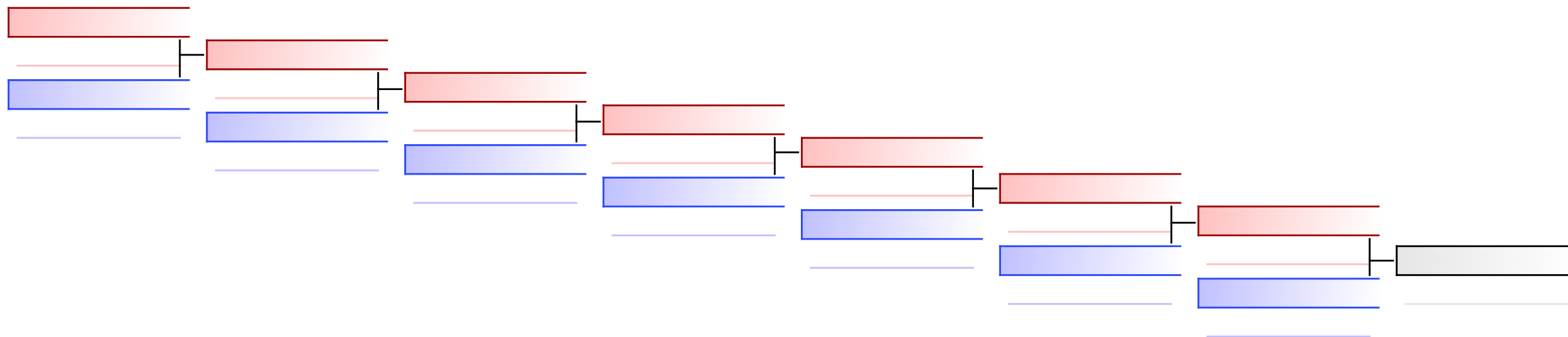

Referees:							
-----------	--	--	--	--	--	--	--

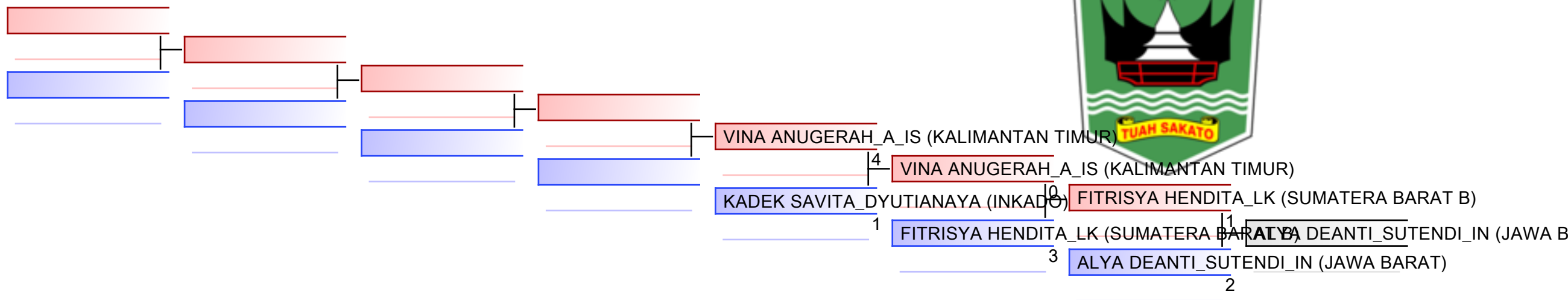

REPECHAGE: (2)

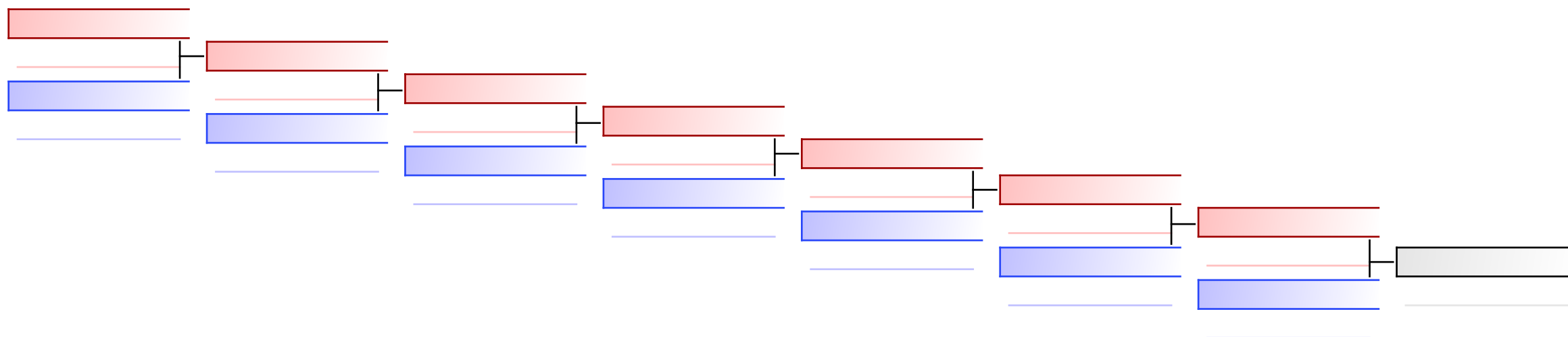

Referees:							
-----------	--	--	--	--	--	--	--

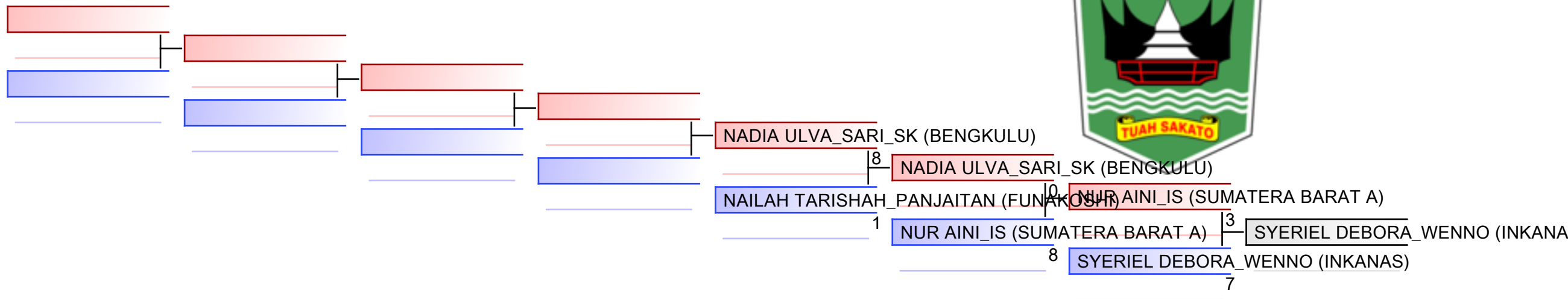

REPECHAGE: (1)

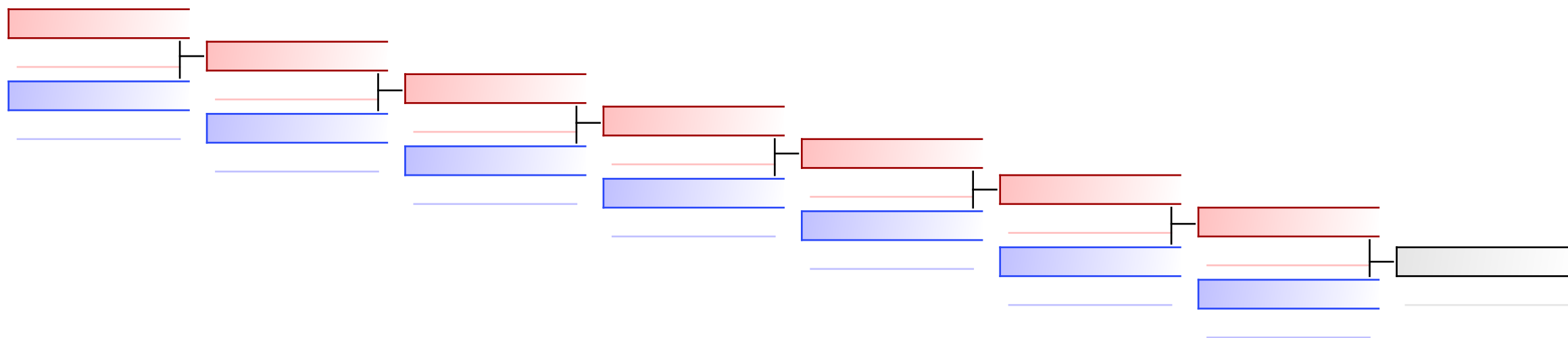

Referees:							
-----------	--	--	--	--	--	--	--

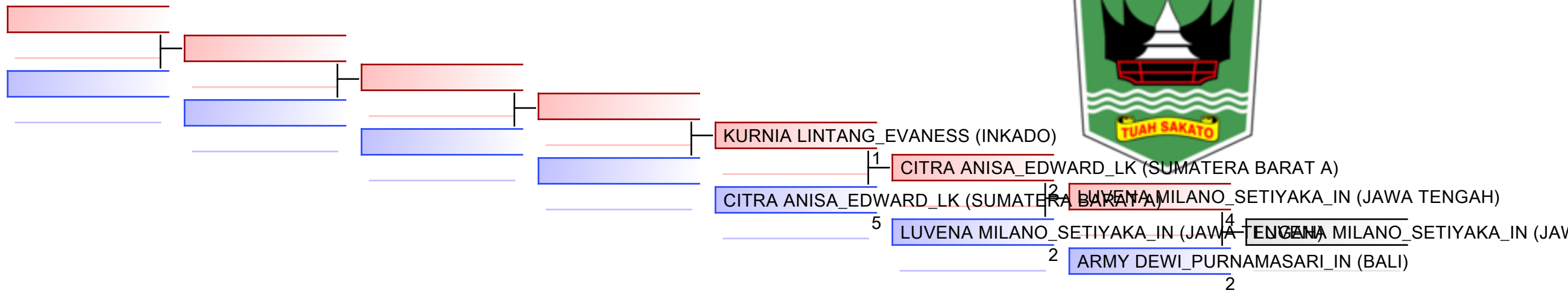

REPECHAGE: (2)

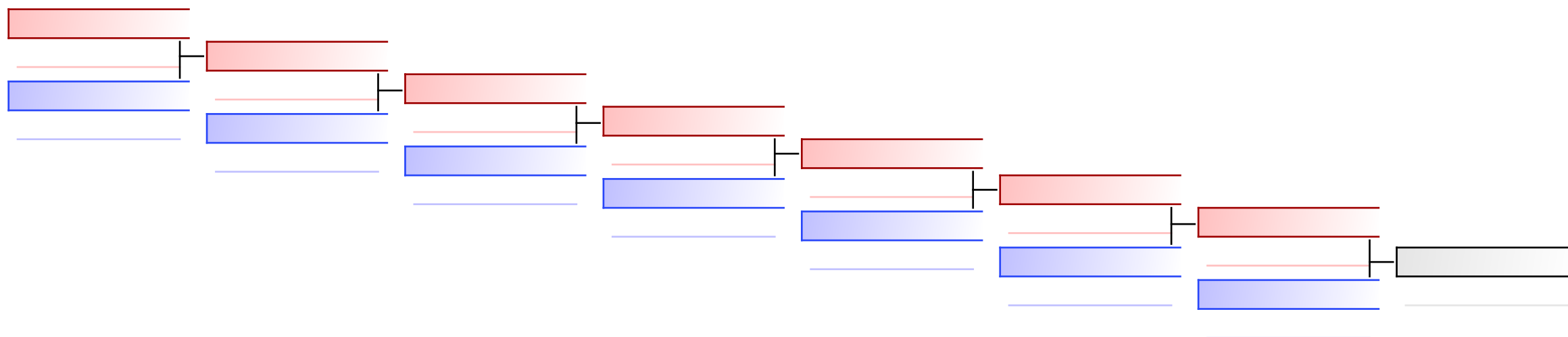

Referees:							
-----------	--	--	--	--	--	--	--

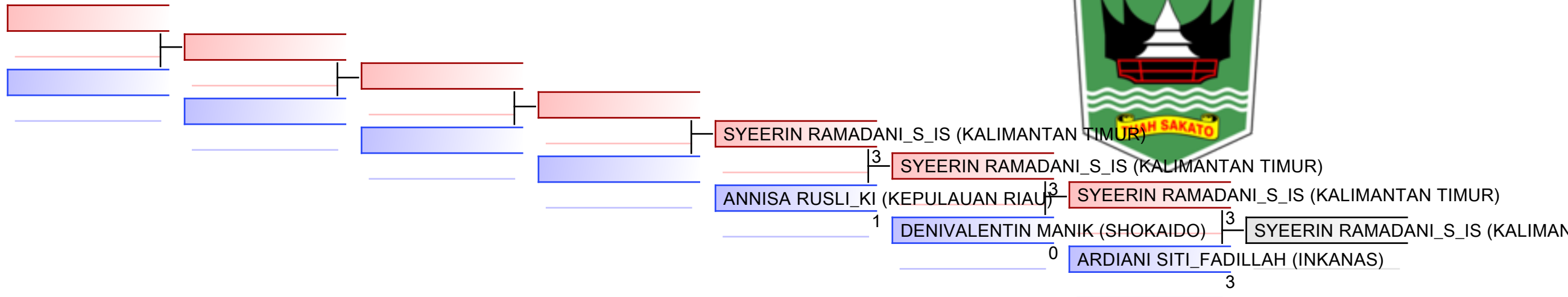

REPECHAGE: (1)

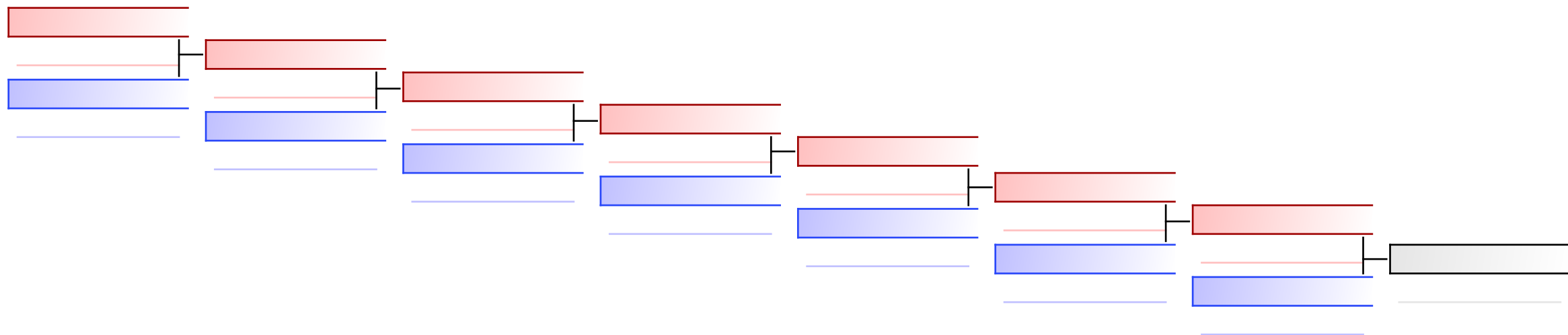

Referees:							
-----------	--	--	--	--	--	--	--



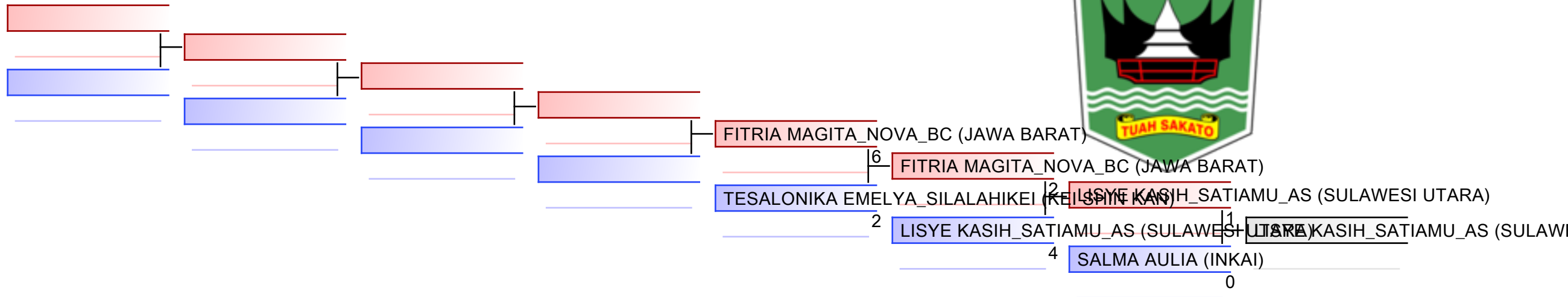

REPECHAGE: (2)

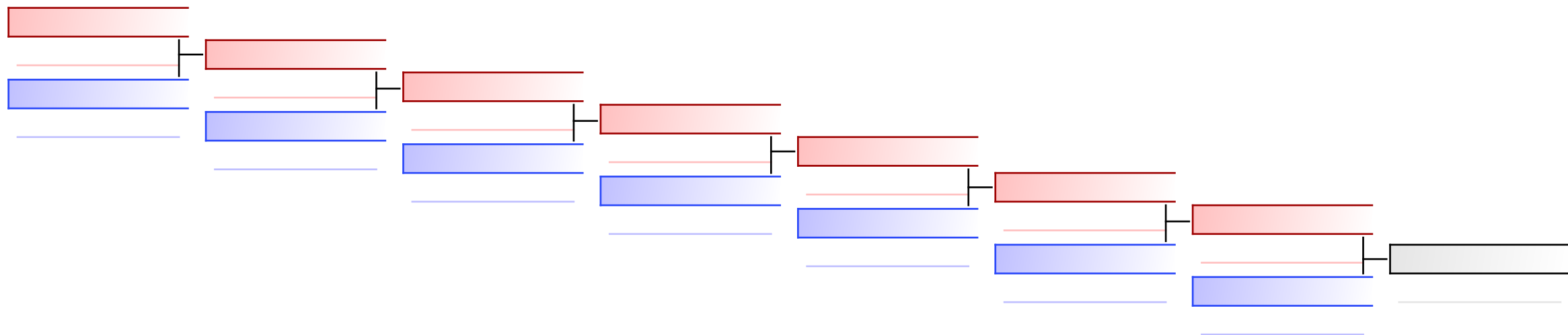

Referees:							
-----------	--	--	--	--	--	--	--

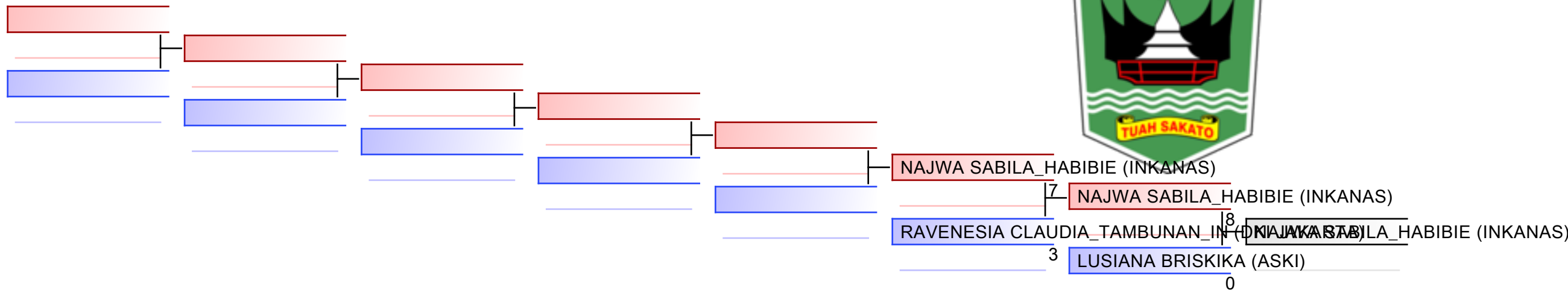

REPECHAGE: (1)

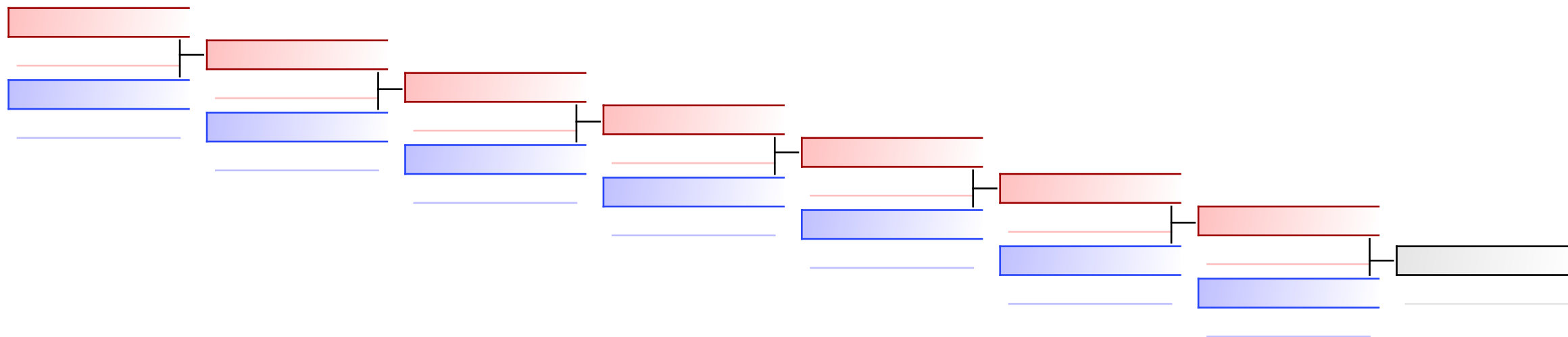

Referees:							
-----------	--	--	--	--	--	--	--

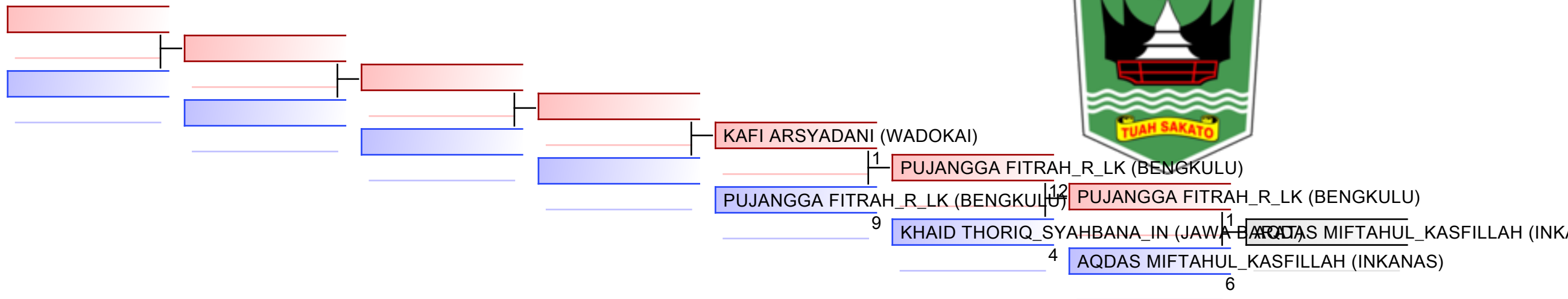

REPECHAGE: (1)

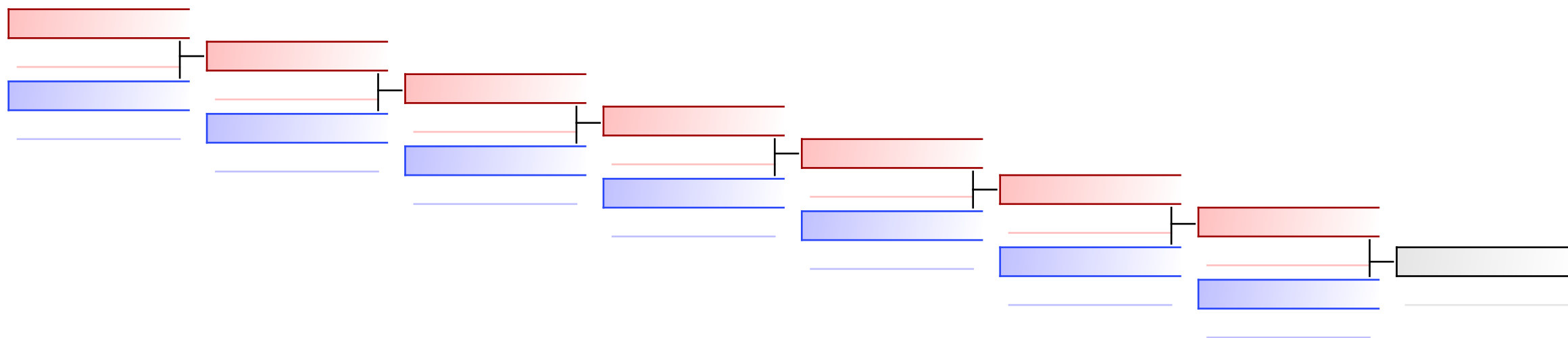

Referees:							
-----------	--	--	--	--	--	--	--

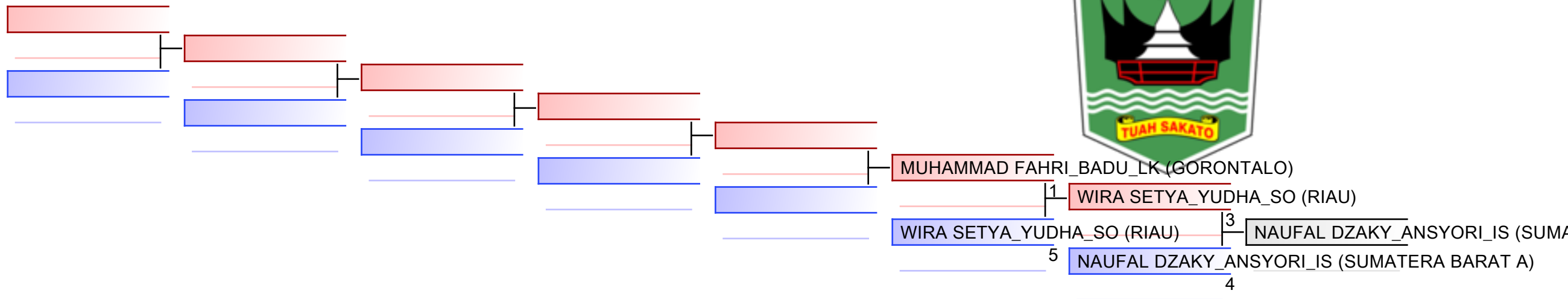

REPECHAGE: (2)

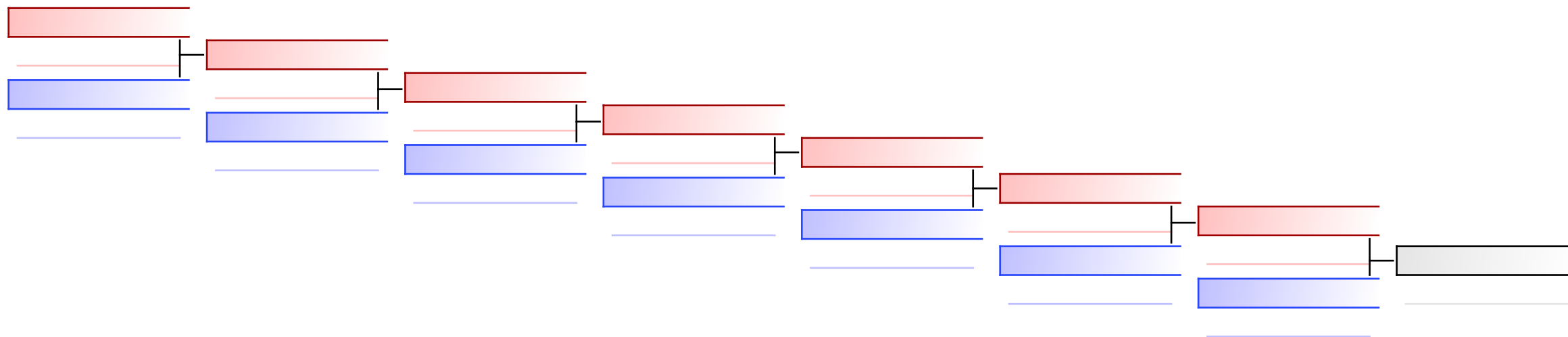

Referees:							
-----------	--	--	--	--	--	--	--

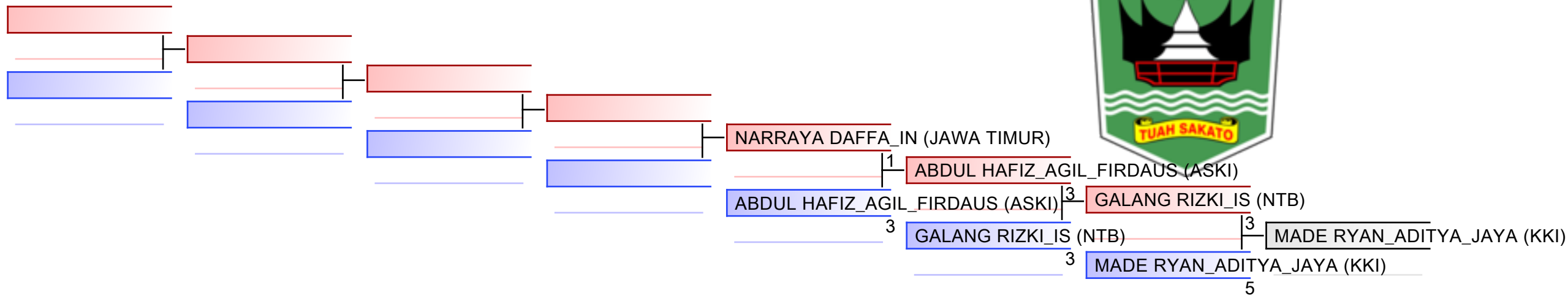

REPECHAGE: (1)

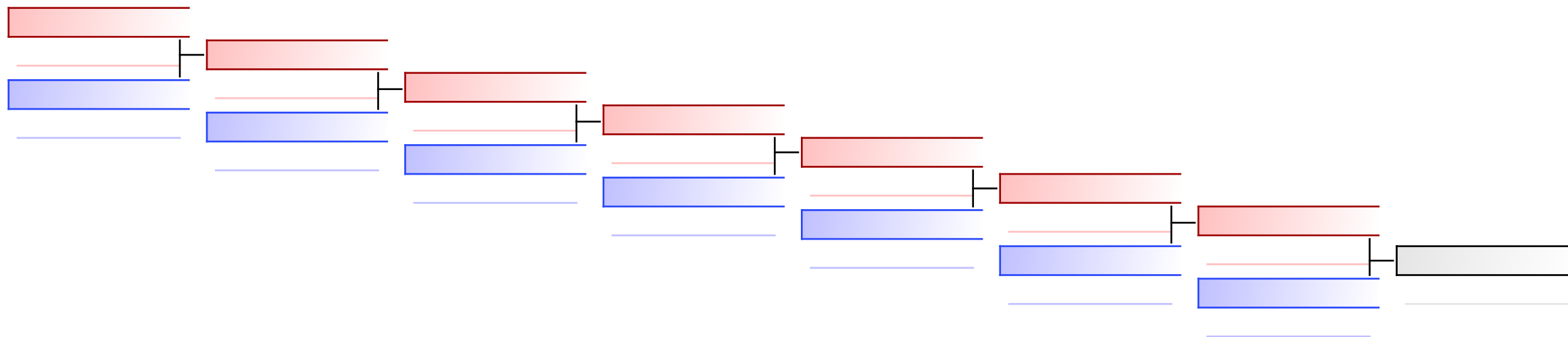

Referees:							
-----------	--	--	--	--	--	--	--

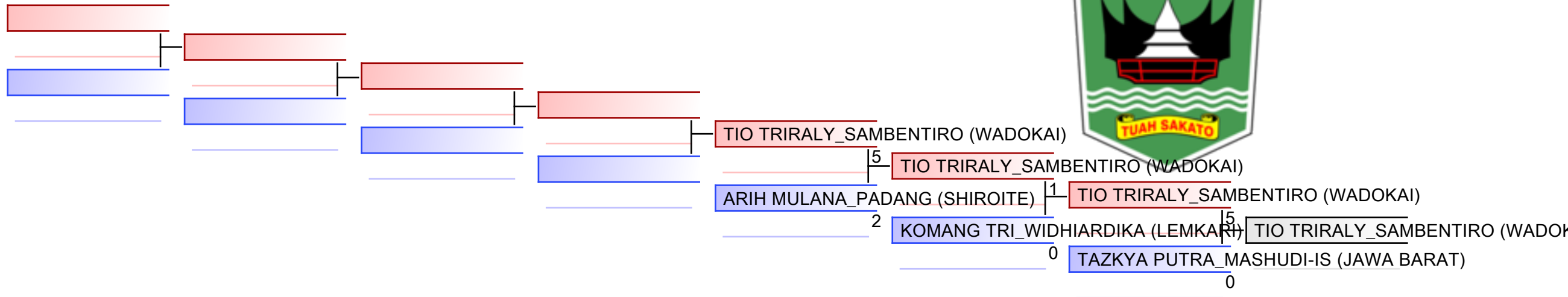

REPECHAGE: (2)

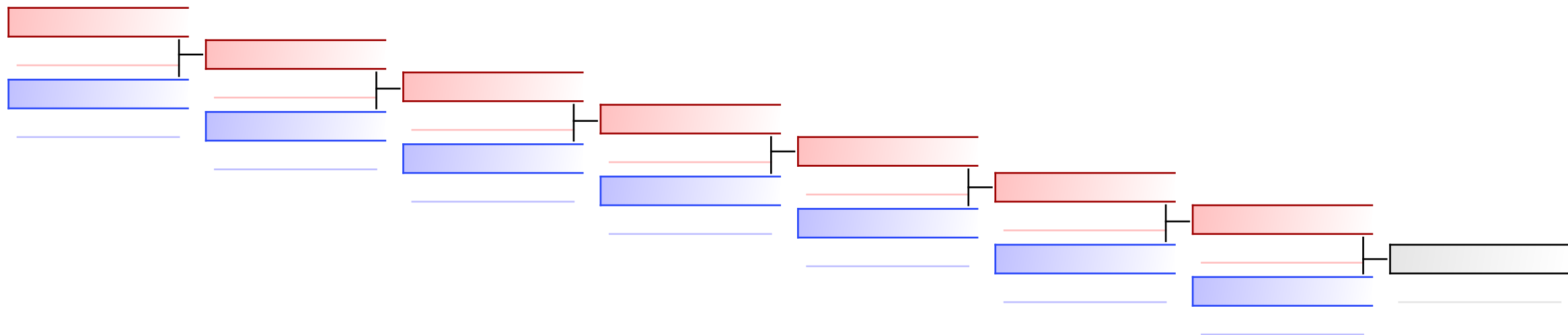

Referees:							
-----------	--	--	--	--	--	--	--

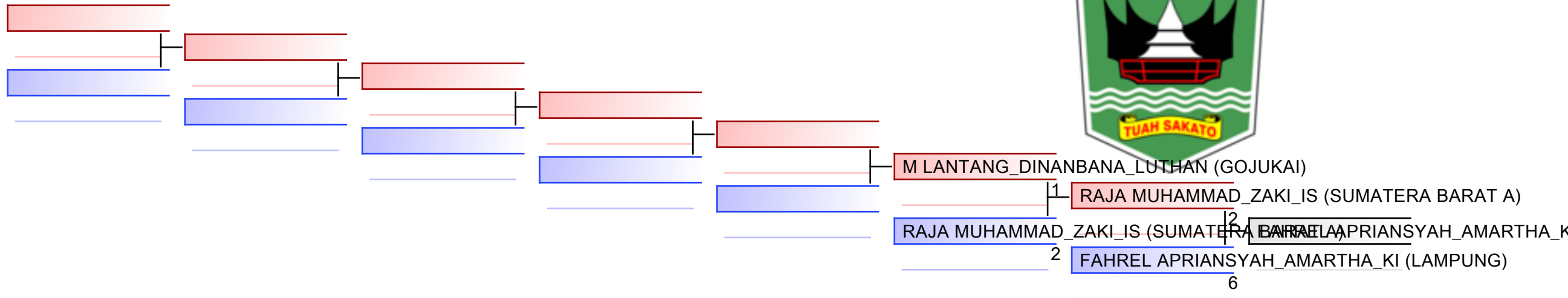

REPECHAGE: (1)

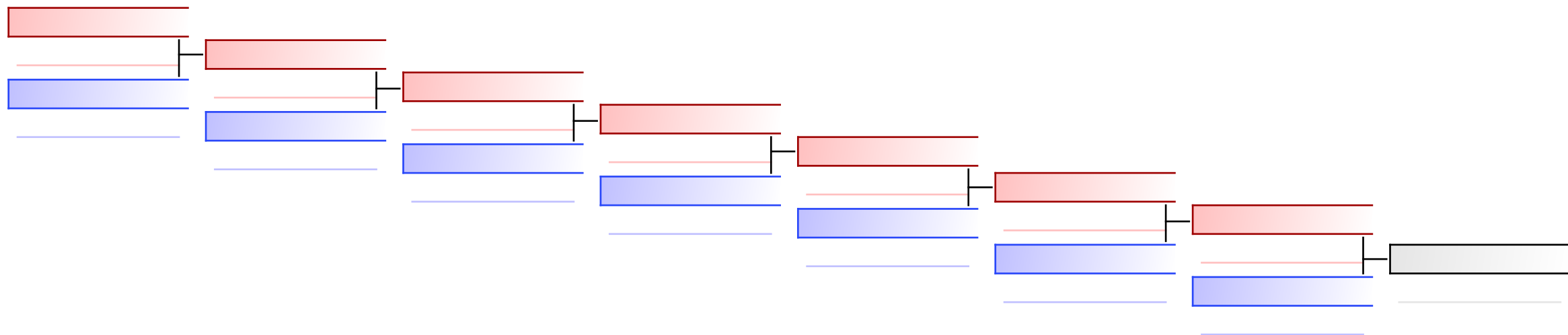

Referees:							
-----------	--	--	--	--	--	--	--

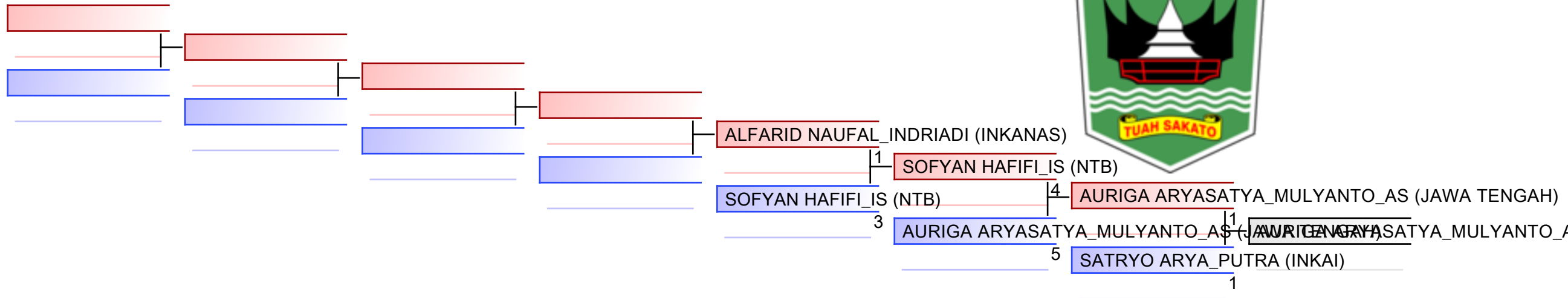

REPECHAGE: (2)

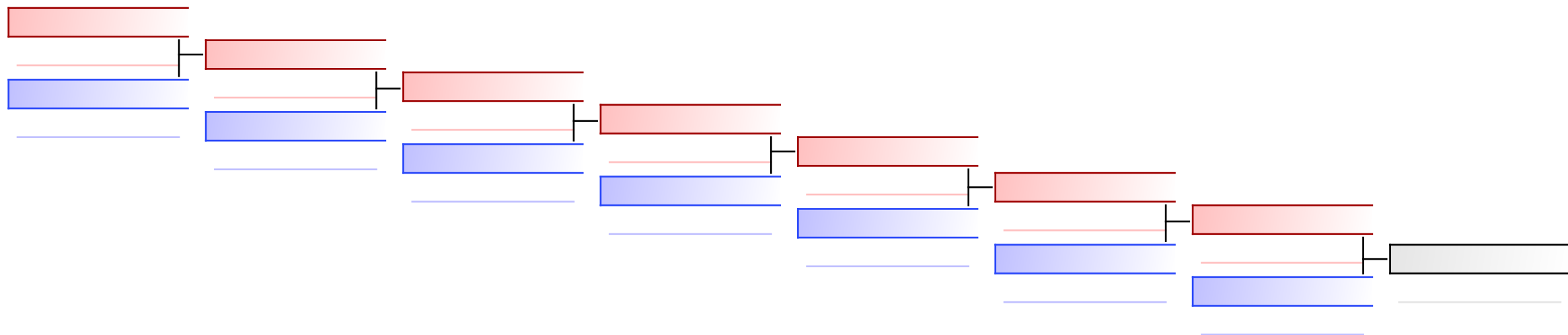

Referees:							
-----------	--	--	--	--	--	--	--



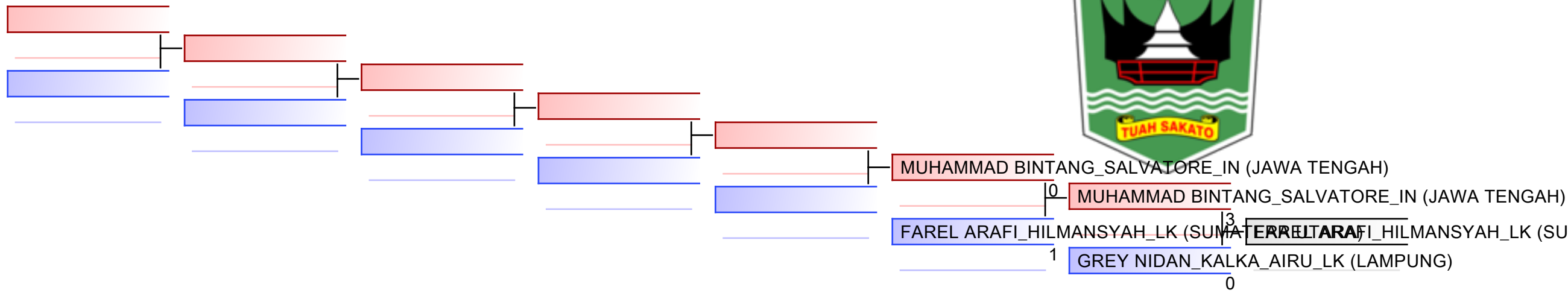

REPECHAGE: (1)

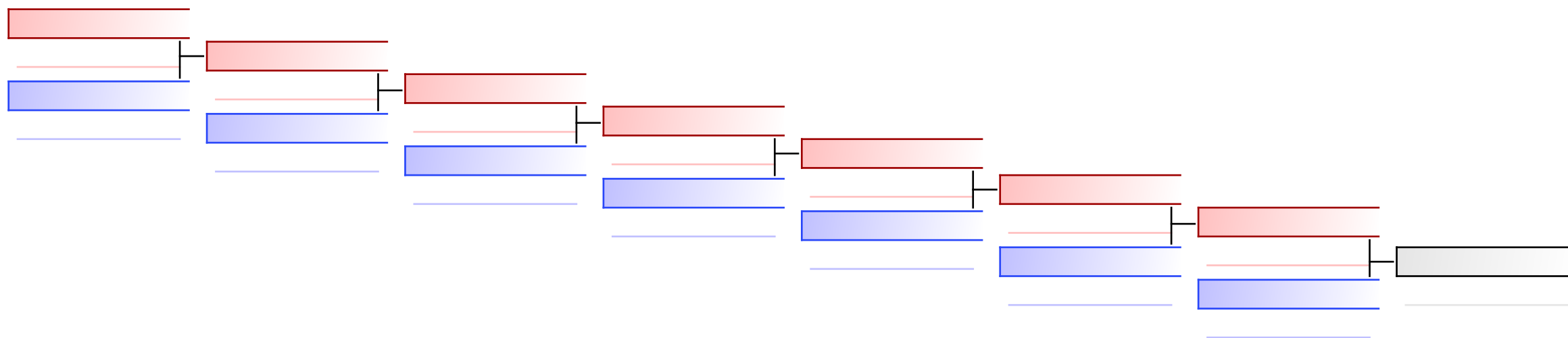

Referees:							
-----------	--	--	--	--	--	--	--

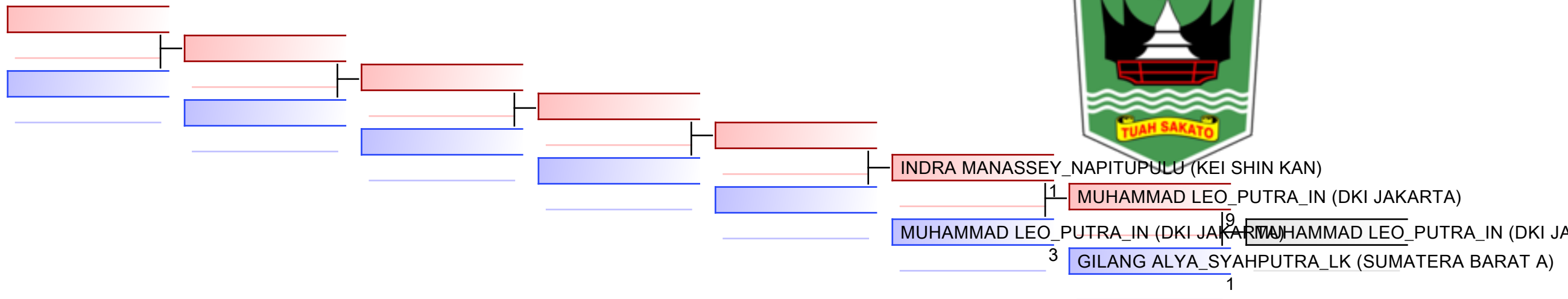

REPECHAGE: (2)

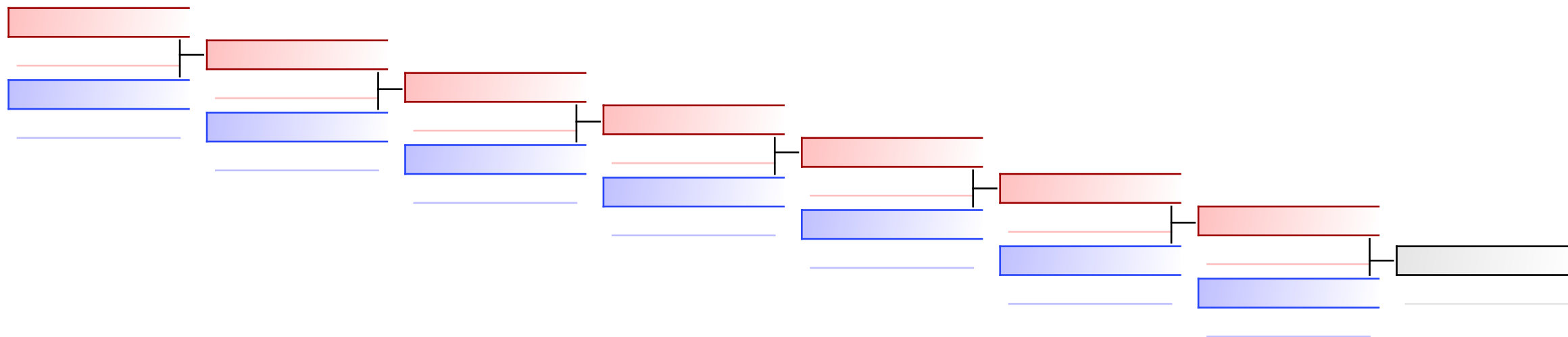

Referees:							
-----------	--	--	--	--	--	--	--

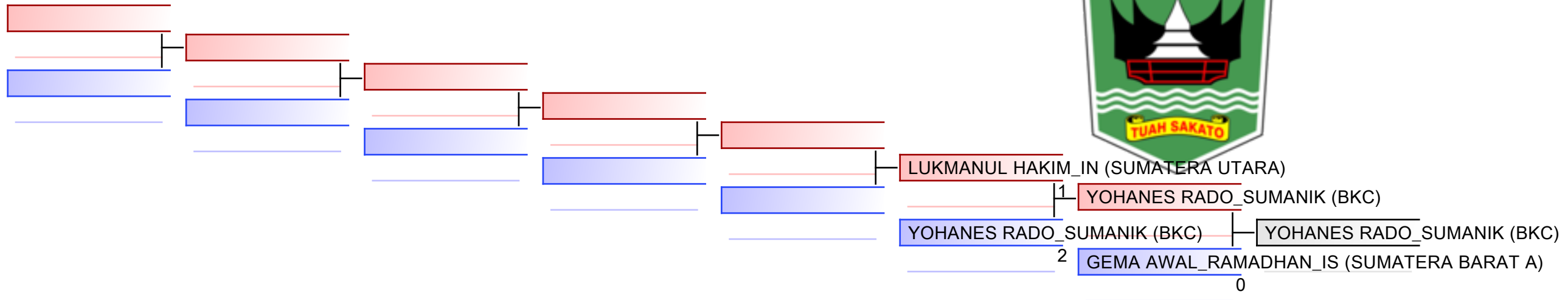

REPECHAGE: (1)

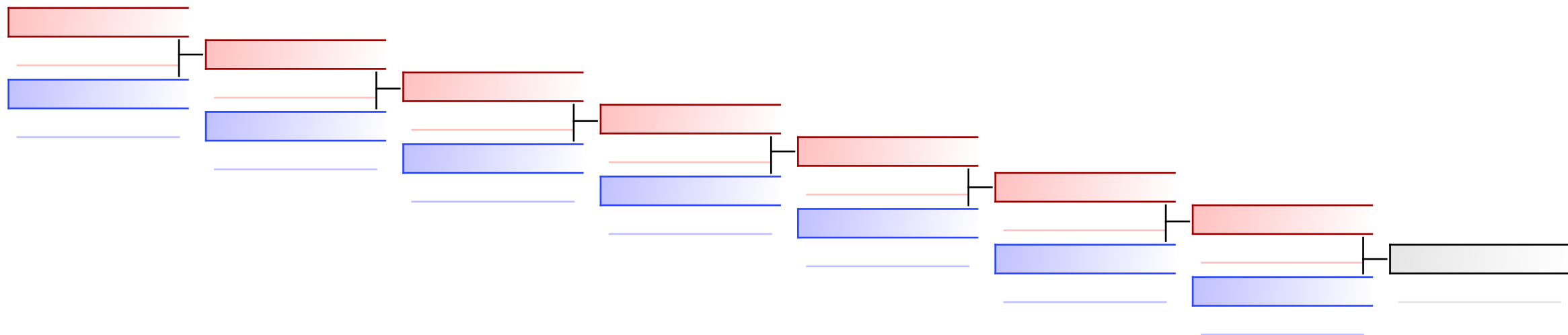

Referees:							
-----------	--	--	--	--	--	--	--

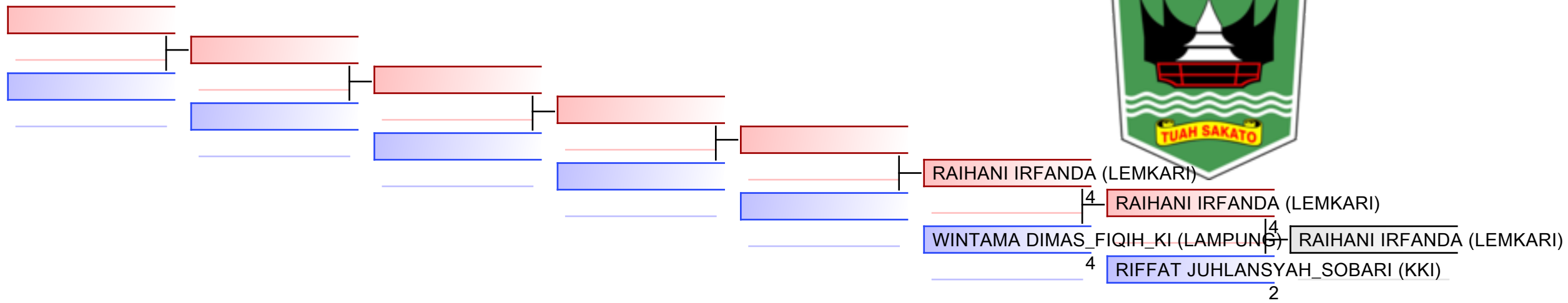

REPECHAGE: (2)

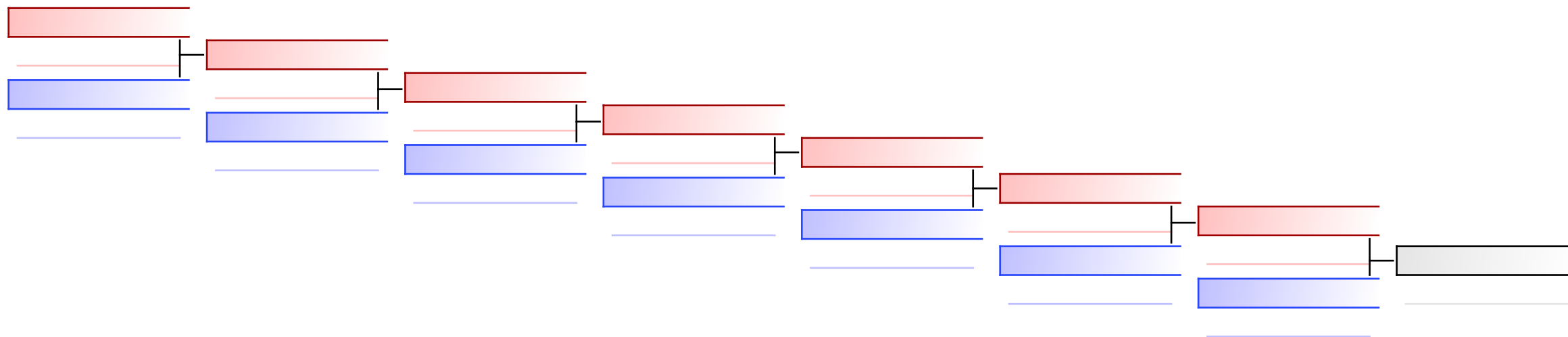

Referees:							
-----------	--	--	--	--	--	--	--

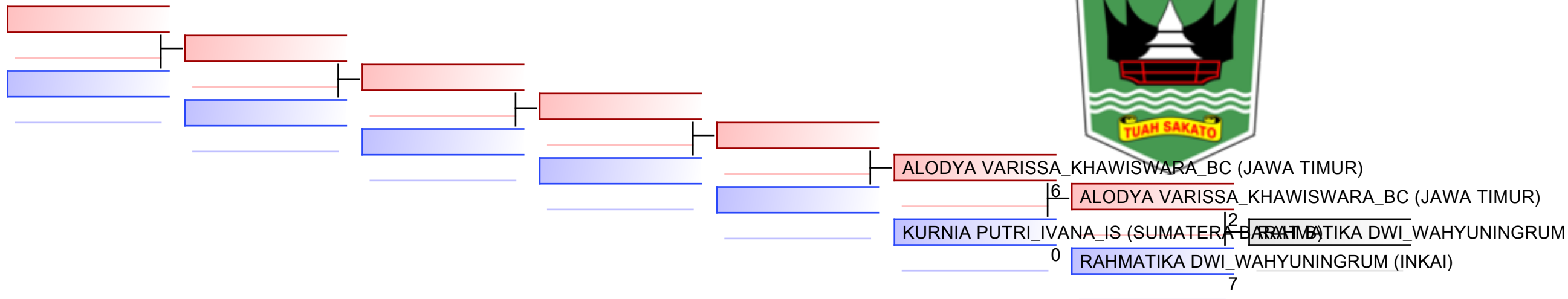

REPECHAGE: (2)

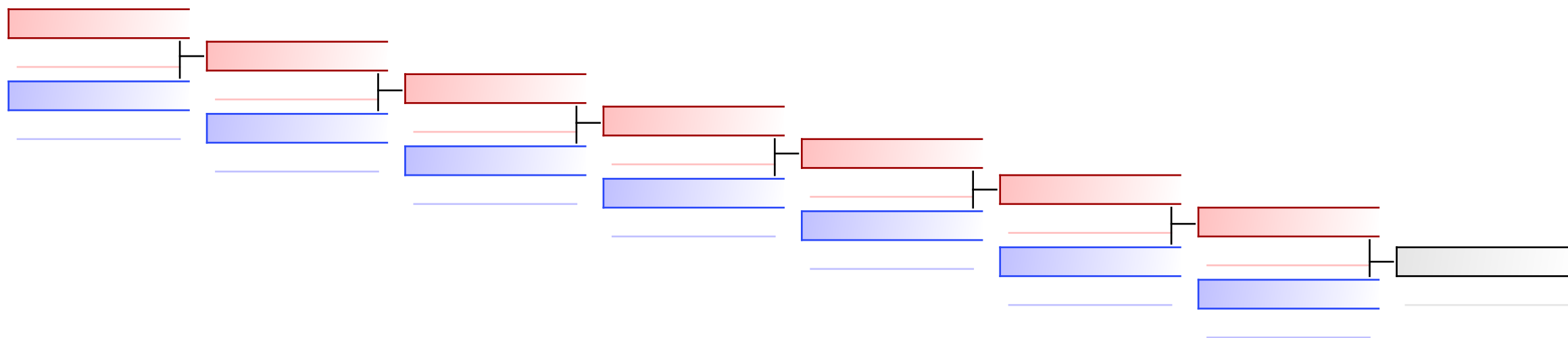

Referees:							
-----------	--	--	--	--	--	--	--

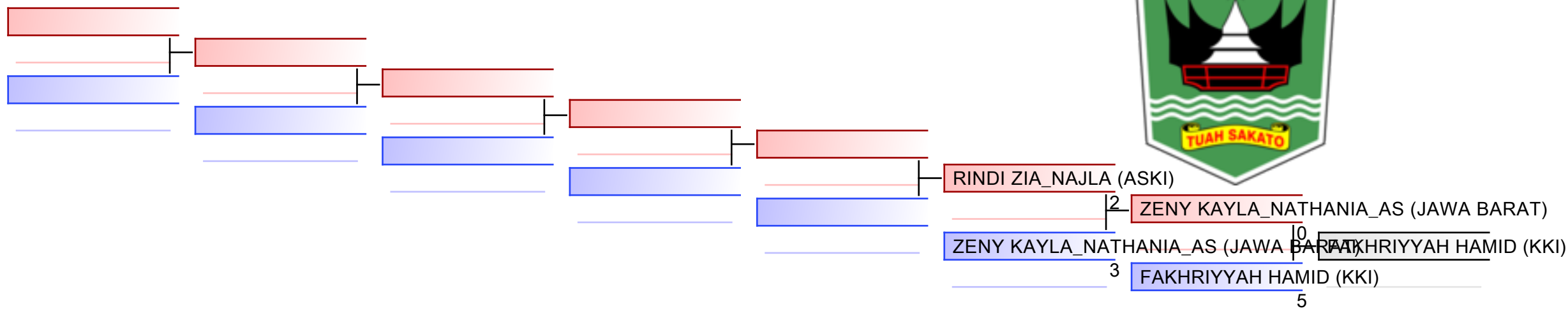

REPECHAGE: (1)

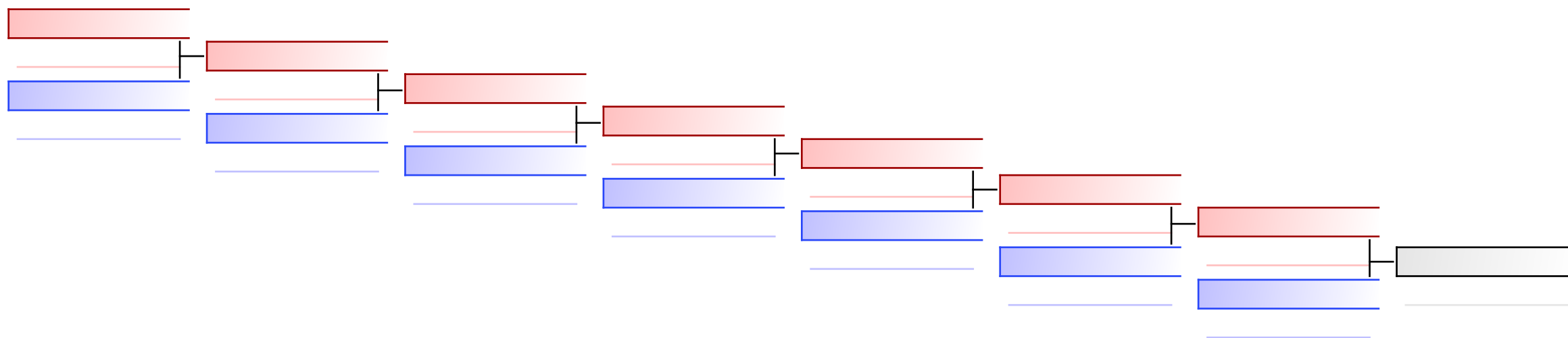

Referees:							
-----------	--	--	--	--	--	--	--

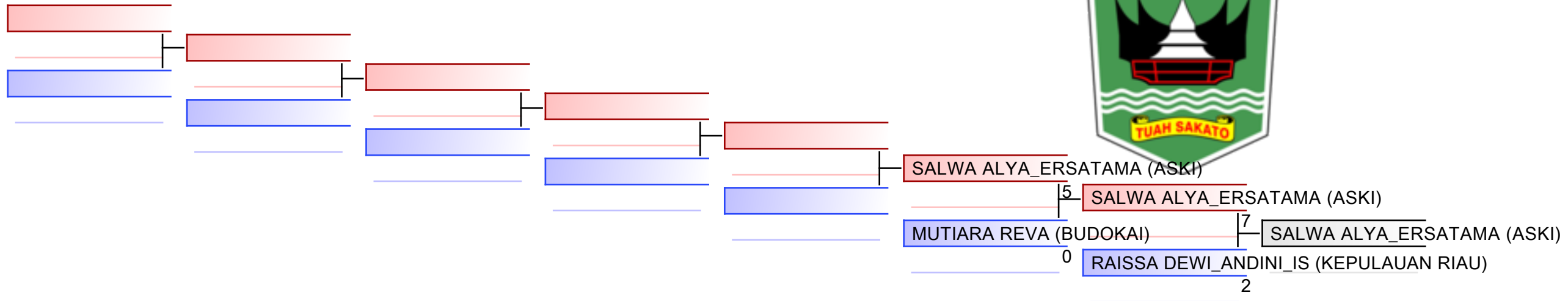

REPECHAGE: (1)

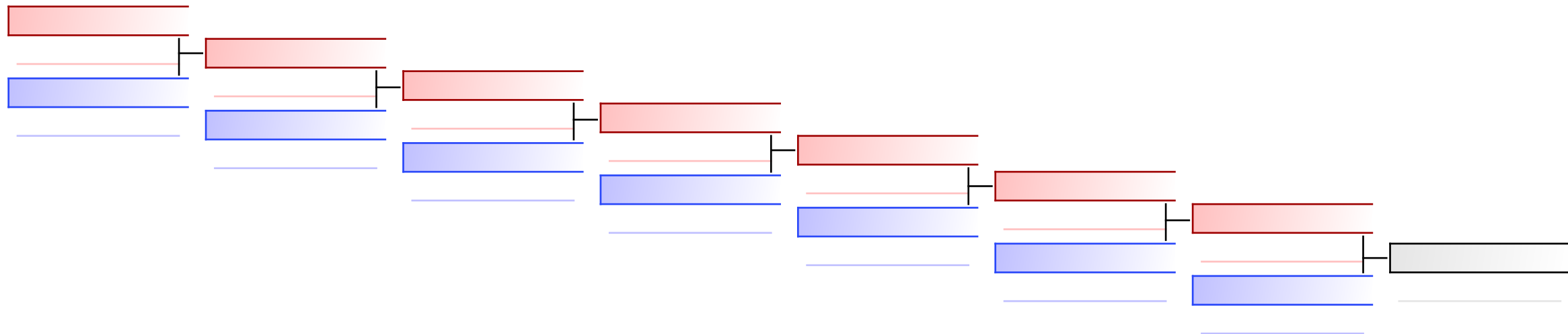

Referees:							
-----------	--	--	--	--	--	--	--

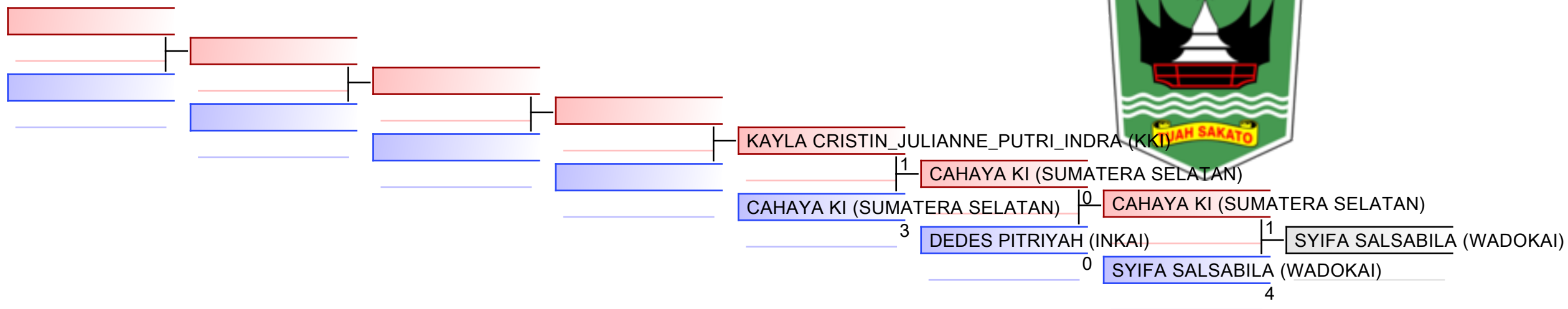

REPECHAGE: (2)

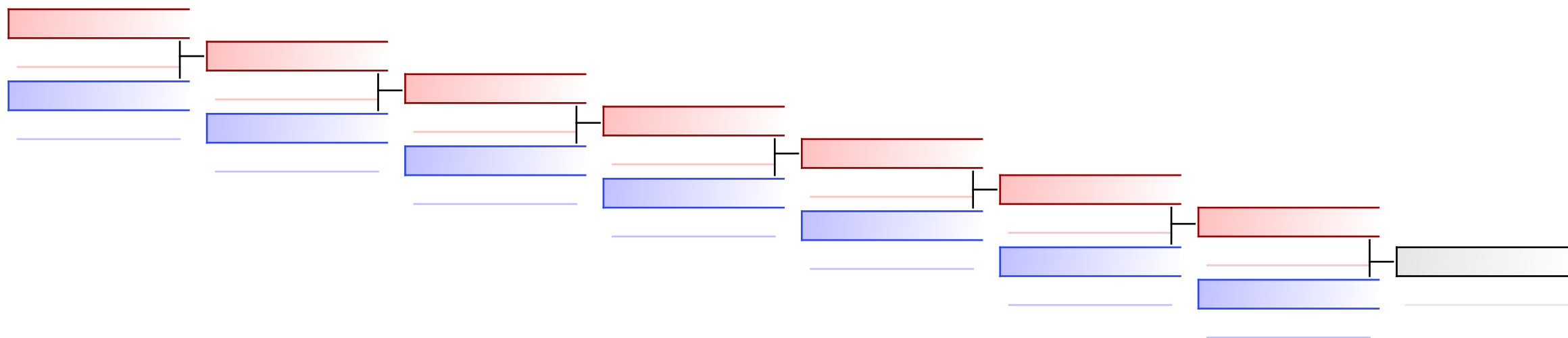

Referees:							
-----------	--	--	--	--	--	--	--



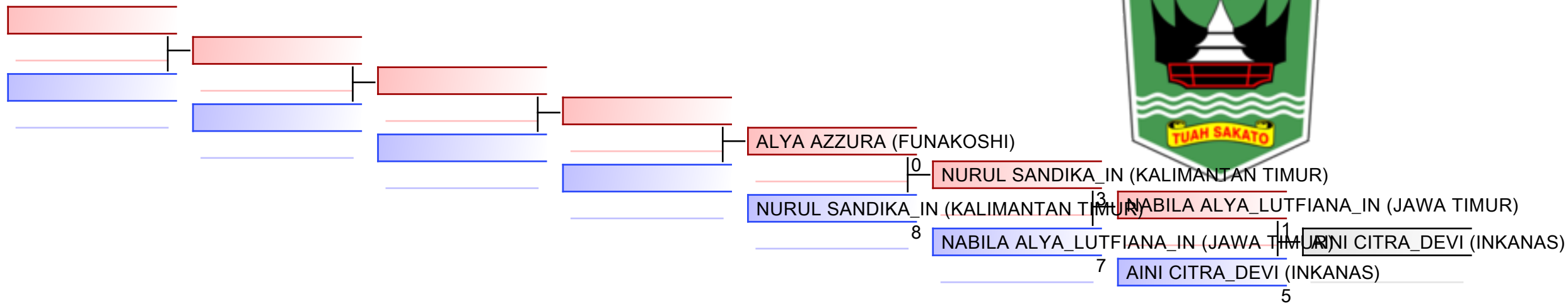

REPECHAGE: (1)

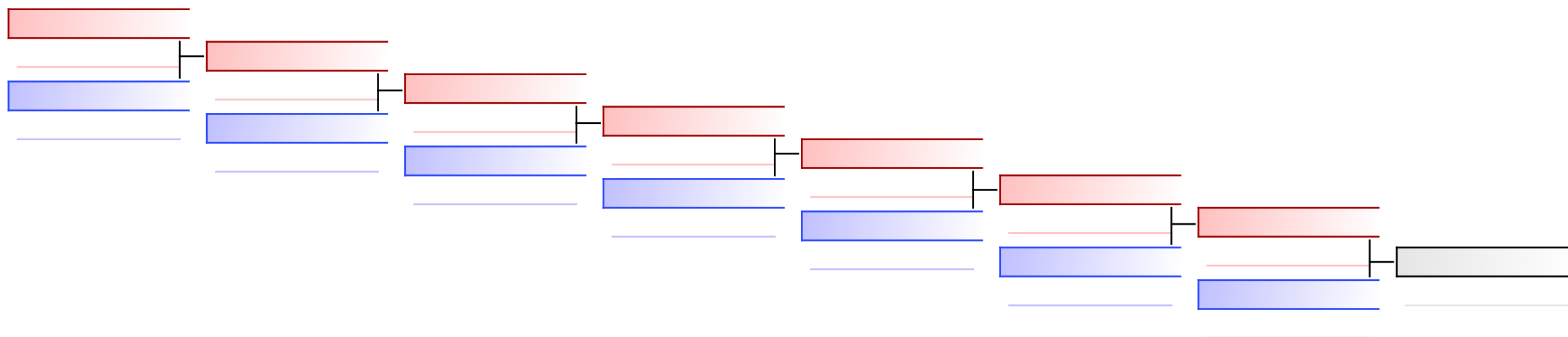

Referees:							
-----------	--	--	--	--	--	--	--

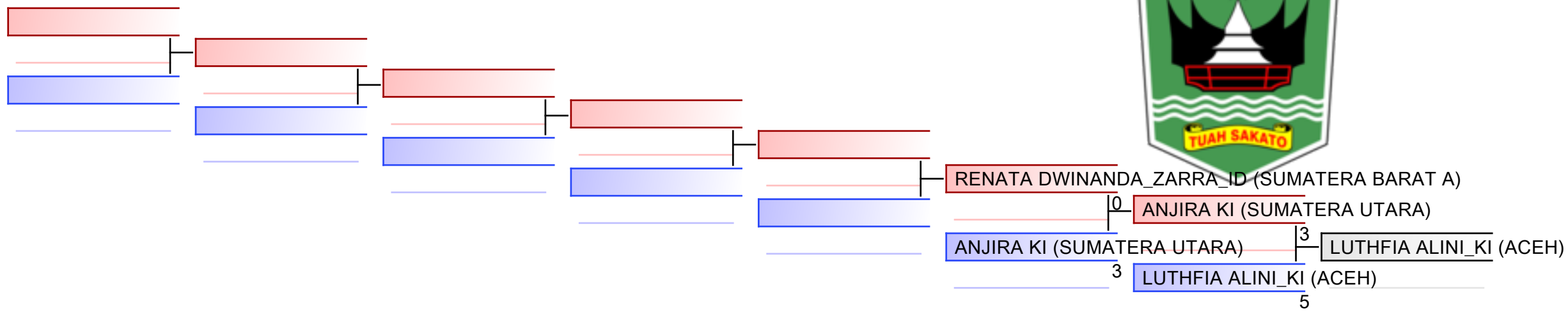

REPECHAGE: (2)

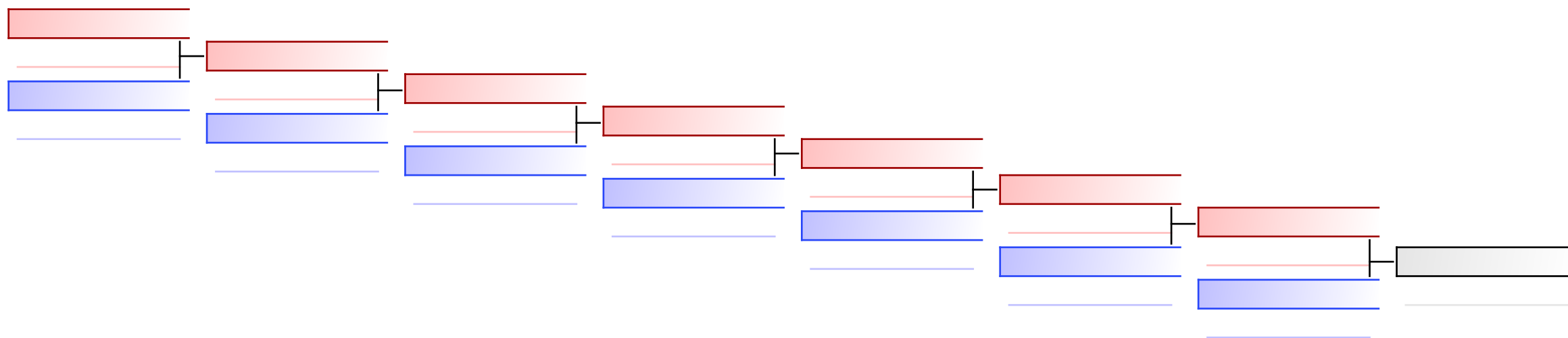

Referees:							
-----------	--	--	--	--	--	--	--