



































**KEJURNAS KARATE CADET, JUNIOR & U21 TAHUN
2021 - 2021-11-05**

Medals - Club

Rank	Club	1. Place	2. Place	3. Place
1	 DKI JAKARTA, INA	10	3	4
2	 INKAI, INA	6	4	7
3	 JAWA BARAT, INA	5	5	4
4	 INKANAS, INA	3	3	7
5	 JAWA TENGAH, INA	3	2	5
6	 BALI, INA	3	1	2
7	 SUMATERA UTARA, INA	2	1	3
8	 ASKI, INA	1	1	2
9	 INKADO, INA	1	1	1
10	 JAWA TIMUR, INA	1	0	2
11	 SUMATERA SELATAN, INA	1	0	1
12	 LAMPUNG, INA	0	4	5
13	 SULAWESI SELATAN, INA	0	2	1
14	 KKI, INA	0	1	5
15	 TAKO, INA	0	1	1
	 LEMKARI, INA	0	1	1
	 BANTEN, INA	0	1	1
18	 SHOTOKAI, INA	0	1	0
	 SUMATERA BARAT, INA	0	1	0
	 GOJUKAI, INA	0	1	0
	 SULAWESI TENGGARA, INA	0	1	0
	 NUSA TENGGARA BARAT, INA	0	1	0
23	 SULAWESI UTARA, INA	0	0	4
24	 RIAU, INA	0	0	2
	 DI YOGYAKARTA, INA	0	0	2
	 GORONTALO, INA	0	0	2
	 GABDIKA SHITORYUKAI, INA	0	0	2
	 PAPUA BARAT, INA	0	0	2
29	 BUDOKAI, INA	0	0	1
	 KEPULAUAN BANGKA BELITUNG, INA	0	0	1
	 MALUKU, INA	0	0	1
	 KEPULAUAN RIAU, INA	0	0	1
	 WADOKAI, INA	0	0	1
	 GOJU ASS, INA	0	0	1

**KEJURNAS KARATE CADET, JUNIOR & U21 TAHUN
2021 - 2021-11-05**

Official Results

JUNIOR KATA BEREGU PUTRA					
1	INKAI TEAM - ABYAN_AL FADHIL_ - RAHMATULLAH_BAGAS PUTRA - NICKY_HARDIANA CAESAR	INKAI		INA - INDONESIA	
2	GOJUKAI TEAM - MUHAMMAD SOFYAN - FATHAM INSYIROH - KAHFI NADHIL	GOJUKAI		INA - INDONESIA	
3	JAKARTA TEAM - MUHAMMAD BAGUS_LAKSAMANA_IN - MOCHAMAD_FAJAR FEBRIAN_DJUNAIIDI_IN - MUHAMMAD_PASYA ARDIANSYAH_IN	DKI JAKARTA		INA - INDONESIA	
3	INKANAS TEAM - AGUS_RIAN KURNIA - MAULANA MALIK_A - RIFKY_FADHLI_NAUFAL HERMAWAN	INKANAS		INA - INDONESIA	





JUNIOR KATA BEREGU PUTRI					
1	JAKARTA TEAM - BEATRIEX_HELENA PANGEMANAN_GK - SORA AMANDA_GK - ZAFIRA_ANGGRAINI WIDODO_GK	DKI JAKARTA		INA - INDONESIA	
2	JABAR TEAM - IVANDA_LEONA PUTRI_TABITA_IN - SITI YASMIN_NUR_LATIFAH_IN - HANA ALIFAH_IN	JAWA BARAT		INA - INDONESIA	
3	INKAI TEAM	INKAI		INA - INDONESIA	

**KEJURNAS KARATE CADET, JUNIOR & U21 TAHUN
2021 - 2021-11-05**





Official Results

	- NABILA_PUTRI RAMADHANI - MALINI_ANGGA RESTA - AJRIYA_NAJWAH NURUL_AINI				
3	INKANAS TEAM - LAYLA_PUTRI MAHARDIKA - SYADZA_NAJLA SYAKIRA - MEISYA RATU_C	INKANAS		INA - INDONESIA	





JUNIOR KATA PERORANGAN PUTRA

1	HAZEL RAMADHAN	JAWA BARAT		INA - INDONESIA	
2	GANDI DARMA PRATAMA	SHOTOKAI		INA - INDONESIA	
3	CHRISTOPHER EDBERT S SI	JAWA TENGAH		INA - INDONESIA	
3	FIRMAN MAULANA	INKANAS		INA - INDONESIA	

JUNIOR KATA PERORANGAN PUTRI

1	LALA DIAH PITALOKA IN	JAWA BARAT		INA - INDONESIA	
2	INDAH FEBRIYANI GK	LAMPUNG		INA - INDONESIA	
3	AGHNIYA ZAMZAMI	INKANAS		INA - INDONESIA	
3	BEATRIEX HELENA PANGEMANAN GK	DKI JAKARTA		INA - INDONESIA	





JUNIOR KUMITE PUTRA +76 KG





1	MAXMILIANO EFENDI	INKAI		INA - INDONESIA	
2	ICHTIAR SION WIJAYA HAREFA	TAKO		INA - INDONESIA	
3	RIZKY ADHA TK	RIAU		INA - INDONESIA	
3	GERI MAULANA HUTAPEA	KEPULAUAN RIAU		INA - INDONESIA	

JUNIOR KUMITE PUTRA -55 KG





**KEJURNAS KARATE CADET, JUNIOR & U21 TAHUN
2021 - 2021-11-05**

Official Results

1	JOSEP MARIANO RATHZINGER	DKI JAKARTA		INA - INDONESIA	
2	YOHANES MUHAMMAD	KKI		INA - INDONESIA	
3	ROMANUS LUTT LUKAS ID	PAPUA BARAT		INA - INDONESIA	
3	MOCHAMAD ALWI MARASABESSY	BUDOKAI		INA - INDONESIA	

JUNIOR KUMITE PUTRA -61 KG					
1	AHMAD ALAYDRUS	INKAI		INA - INDONESIA	
2	AMANDA WISNU SATRIA BC	JAWA TENGAH		INA - INDONESIA	
3	MUHAMMAD GHALIB RAMADHAN-IN	JAWA BARAT		INA - INDONESIA	
3	DAIVA MAHADANA	DKI JAKARTA		INA - INDONESIA	





JUNIOR KUMITE PUTRA -68 KG					
1	ANDHIKA HULIO PRATAMA BECKHAM KI	SUMATERA SELATAN		INA - INDONESIA	
2	GILANG PERMANA AJIE	INKAI		INA - INDONESIA	
3	GILANG RAMADHAN RAMBE-BC	LAMPUNG		INA - INDONESIA	
3	AKBAR TYO PAMUNGKAS	DI YOGYAKARTA		INA - INDONESIA	

JUNIOR KUMITE PUTRA -76 KG					
1	NATHANIEL ABIMANYU	ASKI		INA - INDONESIA	
2	MUHAMMAD MIGUEL LIONEL PUTRO	DKI JAKARTA		INA - INDONESIA	
3	MUHAMMAD GIBRAN	INKANAS		INA - INDONESIA	
3	BIMBIM MAULANA IBRAHIM BC	JAWA BARAT		INA - INDONESIA	





JUNIOR KUMITE PUTRI +59 KG					
-----------------------------------	--	--	--	--	--

**KEJURNAS KARATE CADET, JUNIOR & U21 TAHUN
2021 - 2021-11-05**





Official Results

1	FADILA RAMADANI	INKANAS		INA - INDONESIA	
2	ANISA FITRI ID	SUMATERA BARAT		INA - INDONESIA	
3	MEIVIONA ZUHRINA WK	SUMATERA UTARA		INA - INDONESIA	
3	CEVITA RIZKY IN	BANTEN		INA - INDONESIA	





JUNIOR KUMITE PUTRI -48 KG

1	FARHAH DWI ALYAWATI	DKI JAKARTA		INA - INDONESIA	
2	ALYA DEANTI SUTENDI IN	JAWA BARAT		INA - INDONESIA	
3	BENEDICTA RIEDA LARASATI	ASKI		INA - INDONESIA	
3	RAINA SALMA	INKAI		INA - INDONESIA	



JUNIOR KUMITE PUTRI -53 KG

1	AZFA AULIA IS	JAWA BARAT		INA - INDONESIA	
2	ARNELA PUTRI WANDARI WK	SUMATERA UTARA		INA - INDONESIA	
3	NI RAI BINTANG PUTRI FAJARANI	BALI		INA - INDONESIA	
3	SALSA G P WAHONO-IKD	SULAWESI UTARA		INA - INDONESIA	

JUNIOR KUMITE PUTRI -59 KG

1	LALA TANTRI SAGALA	SUMATERA UTARA		INA - INDONESIA	
2	ANINDITA FAUZIAH D-IS	JAWA BARAT		INA - INDONESIA	
3	NAJWA SABILA HABIBIE IS	GORONTALO		INA - INDONESIA	
3	NI MADE DWI KARTIKA APRIANTI	BALI		INA - INDONESIA	





KADET KATA PERORANGAN PUTRA





1	M AKIO ZAIKO IS	DKI JAKARTA		INA - INDONESIA	
2	AYMAN RAHMAT AL BADI	INKANAS		INA - INDONESIA	
3	ABYAN AL FADHIL	INKAI		INA - INDONESIA	





**KEJURNAS KARATE CADET, JUNIOR & U21 TAHUN
2021 - 2021-11-05**



Official Results

3	ADZI AHMAD DZIKRILLAH	GABDIKA SHITORYUKAI		INA - INDONESIA	
---	-----------------------	------------------------	---	-----------------	--

KADET KATA PERORANGAN PUTRI					
1	NADLIMA LAYLA IN	DKI JAKARTA		INA - INDONESIA	
2	ANDHARA LOIS YOWEIS PUTRO IN	LAMPUNG		INA - INDONESIA	
3	SYIFA AMALIA AKHMAD	INKANAS		INA - INDONESIA	
3	SITI YASMIN NUR LATIFAH IN	JAWA BARAT		INA - INDONESIA	



KADET KUMITE PUTRA +70 KG					
1	MUHAMMAD FAKHRI AUFA ROHMAN	INKAI		INA - INDONESIA	
2	M FIKRI GK	SULAWESI SELATAN		INA - INDONESIA	
3	M PUTRA ANDHIKA KI	SUMATERA SELATAN		INA - INDONESIA	
3	SAUQI ABINATA SAUQI ABINATA IN	JAWA TENGAH		INA - INDONESIA	





KADET KUMITE PUTRA -52 KG					
1	I KADEK JUNI PUTRA IRAWAN	BALI		INA - INDONESIA	
2	ARIEF WIDJAKSONO	SULAWESI SELATAN		INA - INDONESIA	
3	MOCHAMAD RAFAEL	INKANAS		INA - INDONESIA	
3	FAHREL APRIYANSYAH AMARTHA-KI	LAMPUNG		INA - INDONESIA	





KADET KUMITE PUTRA -57 KG					
1	DAMAR ARIF SETIYANTO	INKAI		INA - INDONESIA	
2	MARETTA WISNU ARIEF	JAWA TENGAH		INA - INDONESIA	





**KEJURNAS KARATE CADET, JUNIOR & U21 TAHUN
2021 - 2021-11-05**



Official Results

	MARETTA WISNU ARIEF AS			
3	M ARIQ AL HAKIM-KI	LAMPUNG		INA - INDONESIA
3	LINGGA KURNIAWAN	ASKI		INA - INDONESIA

KADET KUMITE PUTRA -63 KG				
1	RAID DARIS MUZAQQI-IS	JAWA BARAT		INA - INDONESIA
2	MUHAMMAD LEO PUTRA PRADANA	INKAI		INA - INDONESIA
3	I GUSTI AGUNG BRAHMANTRA GAYATH W	KKI		INA - INDONESIA
3	MICHEL CHARIS KARWUR	SULAWESI UTARA		INA - INDONESIA

KADET KUMITE PUTRA -70 KG				
1	I KADEK WISNU JULIARTA	BALI		INA - INDONESIA
2	MUHAMAD ADE WIJAYA-IN	JAWA BARAT		INA - INDONESIA
3	RACKEE BALARAMA IN	JAWA TENGAH		INA - INDONESIA
3	WINTAMA DIMAS FIIH-KI	LAMPUNG		INA - INDONESIA





KADET KUMITE PUTRI +54 KG				
1	ALMAHYRA TIARA SANDI	INKANAS		INA - INDONESIA
2	RAVENESIA CLAUDIA	DKI JAKARTA		INA - INDONESIA
3	SYAIRA AFSARIN GUSTIAN-KI	LAMPUNG		INA - INDONESIA
3	GRAISELLA HELENA TARANDUNG	SULAWESI UTARA		INA - INDONESIA





KADET KUMITE PUTRI -47 KG				
1	RISDA JAYANTI MAHARDIKA-IN	JAWA BARAT		INA - INDONESIA
2	KEISHA AURELYA	ASKI		INA - INDONESIA





**KEJURNAS KARATE CADET, JUNIOR & U21 TAHUN
2021 - 2021-11-05**

Official Results

3	CAROLLIN CASEYPRILIA IN	JAWA TENGAH		INA - INDONESIA	
3	PRIEL RENATA YOSINA HIDOM	INKADO		INA - INDONESIA	

KADET KUMITE PUTRI -54 KG					
1	LUVENA MILANO SETIYAKO IN	JAWA TENGAH		INA - INDONESIA	
2	IMMANIAR ANGELA SUDARNO PUTRI	INKAI		INA - INDONESIA	
3	ARDIANI SITI FADILLA	SUMATERA UTARA		INA - INDONESIA	
3	DELA LUTFIA	LEMKARI		INA - INDONESIA	

U21 KATA PERORANGAN PUTRA					
1	JIBRIL BRILLIANT SMITH ID	INKADO		INA - INDONESIA	
2	OCNIEL JUANDI SIMARMATA	LAMPUNG		INA - INDONESIA	
3	JULIUS EMMANUEL SIHITE	INKAI		INA - INDONESIA	
3	YUDA FADILA PRATAMA BC	JAWA BARAT		INA - INDONESIA	

U21 KATA PERORANGAN PUTRI					
1	SAMRANI NUR AZIZAH IS	DKI JAKARTA		INA - INDONESIA	
2	MARZELLA SEKAR DAMAYANTI	BANTEN		INA - INDONESIA	
3	SEPTRIANI	GOJU ASS		INA - INDONESIA	
3	ANNISA NUR HIDAYAT	GABDIKA SHITORYUKAI		INA - INDONESIA	

U21 KUMITE PUTRA +84 KG					
1	MUHAMMAD ALIF FEBRIAN FIRMAN ATMADIPURA	DKI JAKARTA		INA - INDONESIA	
2	MUHAMMAD BESNUH BILLY BILMONA	INKAI		INA - INDONESIA	

**KEJURNAS KARATE CADET, JUNIOR & U21 TAHUN
2021 - 2021-11-05**





Official Results

3	M ROZI ASRI	PAPUA BARAT		INA - INDONESIA	
3	M FAHRI WIJAYA IN	SULAWESI SELATAN		INA - INDONESIA	





U21 KUMITE PUTRA -55 KG

1	RANDEL FREDERICKY PANTOUW IS	JAWA TIMUR		INA - INDONESIA	
2	ARYA KUSUMA DINATA	LEMKARI		INA - INDONESIA	
3	PRAYOGA DWI CAHYONO	KEPULAUAN BANGKA BELITUNG		INA - INDONESIA	
3	RINALDY RAMADIA	DKI JAKARTA		INA - INDONESIA	



U21 KUMITE PUTRA -60 KG

1	MUHAMMAD RIZKY WK	JAWA TENGAH		INA - INDONESIA	
2	MARSUGIANSYAH ZULFIKAR	DKI JAKARTA		INA - INDONESIA	
3	FRANSISCUS FINA SAUNOA	INKAI		INA - INDONESIA	
3	GRAIN MAESA TAMPI	SULAWESI UTARA		INA - INDONESIA	

U21 KUMITE PUTRA -67 KG

1	ALFIANO ADI RISTIAWAN	INKANAS		INA - INDONESIA	
2	I KOMANG BAGUS SURYADANA	BALI		INA - INDONESIA	
3	BRILLIAN OGI	INKAI		INA - INDONESIA	
3	IMMANUEL HEPRIANTO SIMANJUNTAK KI	SUMATERA UTARA		INA - INDONESIA	





U21 KUMITE PUTRA -75 KG





1	MOHAMMAD FADILLAH	DKI JAKARTA		INA - INDONESIA	
2	IRWANSYAH HAFIDH LUBIS	INKANAS		INA - INDONESIA	
3	RISKIANDO CHARLOS RIHULAY	MALUKU		INA - INDONESIA	





**KEJURNAS KARATE CADET, JUNIOR & U21 TAHUN
2021 - 2021-11-05**



Official Results

	IN			
3	DUSKY MUBARAQ	TAKO		INA - INDONESIA

U21 KUMITE PUTRA -84 KG				
1	REZA MAHENDRA	INKAI		INA - INDONESIA
2	MUHAMMAD SYEIKH MAULANA ZUHUD	INKADO		INA - INDONESIA
3	BAYU BOMANTARA TK	RIAU		INA - INDONESIA
3	AGVYAN RIZKY PRADANA IN	JAWA TENGAH		INA - INDONESIA

U21 KUMITE PUTRI +68 KG				
1	HERA IRNANDHA IN	JAWA TENGAH		INA - INDONESIA
2	DEVI TRIANA ID	SULAWESI TENGGERA		INA - INDONESIA
3	NI KETUT RATIH WULANDARI	KKI		INA - INDONESIA
3	LEDY DEVEGA SAGALA	WADOKAI		INA - INDONESIA





U21 KUMITE PUTRI -50 KG				
1	ANNISA NUR ANGGRAENI	DKI JAKARTA		INA - INDONESIA
2	ABDIRA NADIRASI-IS	NUSA TENGGARA BARAT		INA - INDONESIA
3	FARADILA ADAM IS	GORONTALO		INA - INDONESIA
3	FIQRA DWI SASKIAH	KKI		INA - INDONESIA





U21 KUMITE PUTRI -55 KG				
1	FIFTARI AMELZA	DKI JAKARTA		INA - INDONESIA
2	ISABELLA YOUNE MAMIKERE	INKANAS		INA - INDONESIA
3	ANGURI NASYWA PRASISTA-IN	JAWA TIMUR		INA - INDONESIA

KEJURNAS KARATE CADET, JUNIOR & U21 TAHUN
2021 - 2021-11-05

Official Results

3	SANIA -	KKI		INA - INDONESIA	
---	---------	-----	---	-----------------	--

U21 KUMITE PUTRI -61 KG					
1	NI MADE MERIANTINI	BALI		INA - INDONESIA	
2	AIDA SAFA KAMILAH IN	JAWA BARAT		INA - INDONESIA	
3	THERESIA DEVINA	KKI		INA - INDONESIA	
3	PANGEST ANANDA MAHANANII-AS	DI YOGYAKARTA		INA - INDONESIA	

U21 KUMITE PUTRI -68 KG					
1	VANNESSA EFENDI IN	SUMATERA UTARA		INA - INDONESIA	
2	AYU SULISTIANDARI-LK	LAMPUNG		INA - INDONESIA	
3	MONIKA RESWARA K P-SO	JAWA TIMUR		INA - INDONESIA	
3	SALSABILA RAGIL PUTRI	INKAI		INA - INDONESIA	

KEJURNAS KARATE CADET, JUNIOR
& U21 TAHUN 2021 - 2021-11-05

Official Results

BEST F THE BEST U21 PUTRA				
1	MOHAMMAD FADILLAH	DKI JAKARTA		INA - INDONESIA

BEST F THE BEST U21 PUTRI				
1	VANESSA EFFENDI IN	SUMATERA UTARA		INA - INDONESIA

BEST OF THE BEST JUNIOR PUTRA				
1	JOSEP MARIANO RATHZINGER	DKI JAKARTA		INA - INDONESIA

BEST OF THE BEST JUNIOR PUTRI				
1	FADILA RAMADANI	INKANAS		INA - INDONESIA

BEST OF THE BEST KADET PUTRA				
1	KADEK WISNU JULIARTA	BALI		INA - INDONESIA

BEST OF THE BEST KADET PUTRI				
1	LUVENA MILANO SETIYAKO IN	JAWA TENGAH		INA - INDONESIA

**KEJURNAS KARATE CADET, JUNIOR
& U21 TAHUN 2021 - 2021-11-05
JUNIOR KATA BEREGU PUTRA**

R1 G1/2 (10) Tatami 3 16:45

Competitors	Kata	1T	1A	2T	2A	3T	3A	4T	4A	5T	5A	6T	6A	7T	7A	TEC	ATH	Extra	Total	Rank
1 JABAR TEAM (FADIL_MUHAMMAD, RAFLI, TEGAR) (JABAR)	041 KANKU SHO	(7.2)	(7.2)	(7.4)	(7.4)	7.4	7.4	(7.2)	(7.2)	(7.6)	(7.6)	7.2	7.4	7.4	7.4	15.4	6.66		22.063	
2 SHIROITE TEAM (MUHAMMAD, RAHMAT, VERY_ANDREAS) (SHIROITE)	002 ANAN DAI	(6.4)	(6.4)	(6.6)	(6.4)	(6.4)	(6.8)	(6.8)	6.8	6.4	6.6	6.6	(7.0)	6.4	6.4	13.58	5.94		19.529	
3 BKC TEAM (M_RIDWAN, RYO_RIZKY, VANDU) (BKC)	021 GOJUSHIHO SHO	(6.8)	(6.8)	6.8	(6.8)	6.8	(6.8)	(6.6)	(6.6)	(7.0)	6.8	(7.0)	6.8	6.8	6.8	14.28	6.12		20.4	7
4 INKADO TEAM (BINTANG, JELANG, RENDY) (INKADO)	021 GOJUSHIHO SHO	(7.0)	7.0	7.0	(6.8)	(7.4)	(7.6)	(7.4)	(7.4)	7.2	7.2	7.2	7.2	(6.6)	(6.8)	14.98	6.42		21.4	6
5 BABEL TEAM (M_FAREL, PAULINUS_NONG, QAISHAR) (BABEL)	041 KANKU SHO	(6.6)	(6.4)	(6.4)	(6.2)	(6.4)	6.6	6.6	6.4	(6.8)	(7.0)	6.6	(6.8)	6.4	6.6	13.72	5.88		19.6	8
6 INKAI TEAM (ABYAN_AL, NICKY_HARDIANA, RAHMATULLAH_BAGAS) (INKAI)	041 KANKU SHO	(7.4)	7.4	(7.4)	(7.2)	(7.8)	(7.8)	(7.8)	(7.6)	7.4	7.6	7.6	7.6	7.6	(7.2)	15.82	6.78		22.6	1
7 LEMKARI TEAM (FARIZ_AULIA, MOHAMAD_ALIF, NUGRAHA_SURYA) (LEMKARI)	099 UNSU	(6.8)	(7.0)	(6.8)	(6.8)	7.0	7.2	7.2	(7.4)	(7.4)	(7.4)	(7.4)	7.2	7.2	7.2	14.98	6.48		21.465	
8 JATIM TEAM (ACHMAD_ANVAL, M_RICHAN, RAFLY_AULIA) (JATIM)	021 GOJUSHIHO SHO	(7.2)	(7.0)	7.2	(7.2)	(7.4)	7.2	(7.4)	7.2	7.4	(7.0)	7.4	(7.6)	(7.0)	7.0	15.4	6.42		21.824	
9 WADOKAI TEAM (ATHAILLAH_AFIF, M_INZAGHI_WIDYA, NAYAKA_ABHI_PRAYA) (WADOKAI)	085 SEISHAN	6.2	(6.2)	(5.6)	(5.4)	(6.6)	6.2	(6.8)	(6.6)	6.2	6.2	(5.6)	(5.6)	6.0	6.2	12.88	5.58		18.46	10
10 JATENG TEAM (MUHAMMAD, REHANDANU, SATRIA) (JATENG)	092 SUPARINPEI	7.4	(7.0)	(7.0)	(6.8)	(7.6)	7.2	7.6	(7.8)	(7.8)	(7.6)	(6.6)	7.0	7.6	7.4	15.82	6.48		22.3	2

R1 G2/2 (9) Tatami 4 16:55

Competitors	Kata	1T	1A	2T	2A	3T	3A	4T	4A	5T	5A	6T	6A	7T	7A	TEC	ATH	Extra	Total	Rank
1 JAKARTA TEAM (MOCHAMAD_FAJAR, MUHAMMAD_PASYA, MUHAMMAD) (JAKARTA)	001 ANAN	(7.4)	(7.4)	(7.2)	(6.8)	7.4	7.2	7.2	7.2	(7.6)	(7.6)	7.4	7.4	(7.0)	(7.0)	15.4	6.54		21.944	
2 KEISHINKAN TEAM (M_HAFIZH_FARREL, M_SYHRUL, VALENTINO) (KEISHINKAN)	099 UNSU	(6.8)	(6.6)	6.8	(7.0)	6.8	6.6	(6.6)	6.6	6.8	6.6	(7.0)	(6.8)	(6.2)	(6.0)	14.28	5.94		20.229	
3 BALI TEAM (ANAK_AGUNG, KETUT_BENI_SUDA, PUTU_AGUS_SASTRA) (BALI)	099 UNSU	7.0	6.8	7.2	7.4	(7.6)	(7.6)	(6.8)	6.8	7.0	(6.6)	(7.6)	(7.6)	(6.8)	(6.6)	14.84	6.3		21.147	
4 INKANAS TEAM (AGUS_RIAN, MAULANA, RIFKY_FADHLI_NAUFAL) (INKANAS)	009 CHIBANA NO KUSHANKU	(7.2)	(7.4)	7.6	(7.8)	(7.8)	7.6	7.6	7.4	(7.2)	(7.2)	(7.8)	(7.8)	7.6	7.4	15.96	6.72		22.682	
5 GABDIKA TEAM (ADZI, M, PUTERA) (GABDIKA)	068 PAPUREN	7.2	(7.0)	(8.0)	(7.8)	(7.6)	(7.4)	7.4	7.2	(7.0)	(6.6)	(7.0)	7.2	7.4	7.4	15.4	6.54		21.945	
6 SULAWESI UTARA TEAM (ARYADINATA, CHRISTIVO, KEVIN) (SULUT)	064 OHAN DAI	(6.8)	(6.8)	(7.4)	(7.6)	(7.2)	(7.0)	7.0	7.0	(6.8)	6.8	7.2	7.0	6.8	(6.6)	14.7	6.24		20.948	
7 GOJUKAI TEAM (FATHAM, KAHFI, MUHAMMAD) (GOJUKAI)	086 SEISAN	(7.2)	(6.8)	(8.0)	(8.2)	(7.6)	(7.4)	7.6	7.6	7.8	7.6	(8.0)	(7.8)	7.6	7.6	16.1	6.84		22.941	
8 GOJU ASS TEAM (ABDURRAHMAN, ADI, GHOFAR) (GOJU ASS)	068 PAPUREN	(7.4)	(7.0)	(7.2)	(7.6)	(7.4)	7.2	(7.0)	7.2	7.2	(7.0)	7.4	(7.4)	7.2	7.0	15.26	6.42		21.686	
9 SHOKAIDO TEAM (ABDUL, NAFIS_BUDI, RAFLI) (SHOKAIDO)	078 SANSAN	(7.0)	7.4	(7.6)	(8.0)	7.4	(7.2)	(7.0)	7.2	7.4	(7.0)	(7.8)	(7.8)	7.2	7.4	15.4	6.6		22.0	3

R2-G1 Tatami 3 17:35

Competitors	Kata	1T	1A	2T	2A	3T	3A	4T	4A	5T	5A	6T	6A	7T	7A	TEC	ATH	Extra	Total	Rank
1 INKAI TEAM (ABYAN_AL, NICKY_HARDIANA, RAHMATULLAH_BAGAS) (INKAI)	021 GOJUSHIHO SHO	(7.4)	(7.6)	(7.8)	(7.4)	(7.6)	(7.6)	(7.4)	7.6	7.4	(7.4)	7.4	7.6	7.6	7.6	15.68	6.84		22.521	
2 JATIM TEAM (ACHMAD_ANVAL, M_RICHAN, RAFLY_AULIA) (JATIM)	041 KANKU SHO	(7.2)	(7.2)	(7.4)	(7.2)	7.4	(7.8)	(7.2)	7.4	7.2	7.2	(7.8)	(8.0)	7.4	7.2	15.4	6.54		21.944	
3 JABAR TEAM (FADIL_MUHAMMAD, RAFLI, TEGAR) (JABAR)	021 GOJUSHIHO SHO	(7.4)	(7.2)	(7.6)	(7.4)	(8.0)	(7.8)	7.4	7.4	7.4	(7.2)	7.4	7.4	(7.2)	7.2	15.54	6.6		22.143	
4 JATENG TEAM (MUHAMMAD, REHANDANU, SATRIA) (JATENG)	002 ANAN DAI	7.4	7.4	(7.8)	(7.6)	(7.8)	(7.8)	7.2	(7.2)	(7.0)	7.4	(6.8)	(7.0)	7.6	7.4	15.54	6.66		22.2	2

R2-G2 Tatami 4 17:40

Competitors	Kata	1T	1A	2T	2A	3T	3A	4T	4A	5T	5A	6T	6A	7T	7A	TEC	ATH	Extra	Total	Rank
1 SHOKAIDO TEAM (ABDUL, NAFIS_BUDI, RAFLI) (SHOKAIDO)	001 ANAN	(7.4)	(7.6)	(7.4)	(7.4)	(7.2)	(7.4)	7.2	(7.0)	7.2	7.4	(7.0)	7.4	7.2	7.4	15.12	6.66		21.784	
2 JAKARTA TEAM (MOCHAMAD_FAJAR, MUHAMMAD_PASYA, MUHAMMAD) (JAKARTA)	041 KANKU SHO	(7.2)	(7.2)	(7.2)	(7.2)	7.4	(7.4)	(7.6)	(7.4)	(7.6)	7.4	7.2	7.4	7.4	7.4	15.4	6.66		22.063	
3 INKANAS TEAM (AGUS_RIAN, MAULANA, RIFKY_FADHLI_NAUFAL) (INKANAS)	064 OHAN DAI	(7.4)	(7.2)	(7.6)	(7.4)	(7.2)	7.4	7.4	(7.2)	(8.0)	(7.8)	7.4	7.4	7.6	7.4	15.68	6.66		22.342	
4 GOJUKAI TEAM (FATHAM, KAHFI, MUHAMMAD) (GOJUKAI)	068 PAPUREN	7.6	7.6	(7.4)	(7.4)	7.6	7.6	(7.8)	(7.8)	(8.0)	(7.8)	(7.2)	(7.2)	7.8	7.6	16.1	6.84		22.941	

R3 Bronze Medal Match 1 Tatami 3 17:55

Competitors	Kata	1T	1A	2T	2A	3T	3A	4T	4A	5T	5A	6T	6A	7T	7A	TEC	ATH	Extra	Total	Rank
-------------	------	----	----	----	----	----	----	----	----	----	----	----	----	----	----	-----	-----	-------	-------	------

**KEJURNAS KARATE CADET, JUNIOR
& U21 TAHUN 2021 - 2021-11-05
JUNIOR KATA BEREKU PUTRA**

1	JATENG TEAM (MUHAMMAD, REHANDANU, SATRIA) (JATENG)	001 ANAN	(7.4)	(7.4)	(7.2)	(7.0)	(7.4)	(7.6)	(7.2)	(7.0)	7.2	7.0	7.4	7.2	7.4	7.4	15.4	6.48		21.882
2	JAKARTA TEAM (MOCHAMAD_FAJAR, MUHAMMAD_PASYA, MUHAMMAD) (JAKARTA)	099 UNSU	(7.6)	(7.6)	(7.8)	(7.6)	7.6	7.6	(7.2)	(7.0)	7.4	(7.2)	(7.2)	7.2	7.2	7.2	15.54	6.6		22.141









R3 Bronze Medal Match 2 Tatami 4 18:00

Competitors	Kata	1T	1A	2T	2A	3T	3A	4T	4A	5T	5A	6T	6A	7T	7A	TEC	ATH	Extra	Total Rank
1 JABAR TEAM (FADIL_MUHAMMAD, RAFLI, TEGAR) (JABAR)	099 UNSU	(7.4)	(7.6)	(7.2)	7.4	7.4	7.4	(7.6)	(7.6)	(7.2)	(7.0)	7.4	7.4	7.2	(7.2)	15.4	6.66		22.062
2 INKANAS TEAM (AGUS_RIAN, MAULANA, RIFKY_FADHLI_NAUFAL) (INKANAS)	099 UNSU	(7.6)	(7.6)	(7.4)	(7.6)	(7.4)	(7.2)	(7.6)	7.4	7.4	(6.8)	7.6	7.6	7.4	7.4	15.68	6.72		22.4 1

R3 Gold Medal Match Tatami 3 18:05

Competitors	Kata	1T	1A	2T	2A	3T	3A	4T	4A	5T	5A	6T	6A	7T	7A	TEC	ATH	Extra	Total Rank
1 INKAI TEAM (ABYAN_AL, NICKY_HARDIANA, RAHMATULLAH_BAGAS) (INKAI)	099 UNSU	7.8	(7.8)	7.8	7.8	(8.4)	(8.0)	(7.4)	(7.4)	7.8	7.8	(8.0)	(8.2)	(7.6)	7.8	16.38	7.02		23.4 1
2 GOJUKAI TEAM (FATHAM, KAHFI, MUHAMMAD) (GOJUKAI)	047 KURURUNFA	(7.6)	(7.6)	(7.6)	(7.4)	7.6	(7.4)	7.6	7.4	(7.4)	7.4	7.6	(7.8)	(7.4)	7.4	15.96	6.66		22.622

Results

1	INKAI TEAM - ABYAN_AL FADHIL - RAHMATULLAH_BAGAS PUTRA - NICKY_HARDIANA CAESAR	INKAI		INDONESIA
2	GOJUKAI TEAM - MUHAMMAD SOFYAN - FATHAM INSYIROH - KAHFI NADHIL	GOJUKAI		INDONESIA
3	JAKARTA TEAM - MUHAMMAD BAGUS_LAKSAMANA_IN - MOCHAMAD_FAJAR FEBRIAN_DJUNAIDI_IN - MUHAMMAD_PASYA ARDIANSYAH_IN	DKI JAKARTA		INDONESIA
3	INKANAS TEAM - AGUS_RIAN KURNIA - MAULANA MALIK_A - RIFKY_FADHLI_NAUFAL HERMAWAN	INKANAS		INDONESIA
5	JATENG TEAM - MUHAMMAD RAFFI_BD - REHANDANU ARYASUTA_BD - SATRIA NURWAHYU_BD	JAWA TENGAH		INDONESIA
5	JABAR TEAM - RAFLI RAHADI_IS - FADIL_MUHAMMAD RAHMAN_IS - TEGAR CATUR_WICAKSANA_IS	JAWA BARAT		INDONESIA
7	JATIM TEAM - RAFLY_AULIA PRATAMA_IN - M_RICHAN ARIFIN_IN - ACHMAD_ANVAL ADAIN_IN	JAWA TIMUR		INDONESIA
7	SHOKAIDO TEAM - NAFIS_BUDI RIANTO - ABDUL RAHMAN - RAFLI AHMAD	SHOKAIDO		INDONESIA

**KEJURNAS KARATE CADET, JUNIOR
& U21 TAHUN 2021 - 2021-11-05
JUNIOR KATA BEREGU PUTRI**

R1 G1/2 (7) Tatami 1 16:55

Competitors	Kata	1T	1A	2T	2A	3T	3A	4T	4A	5T	5A	6T	6A	7T	7A	TEC	ATH	Extra	Total	Rank
1 JABAR TEAM (HANA, IVANDA_LEONA, SITI) (JABAR)	068 PAPUREN	(7.6)	(7.6)	(7.6)	(7.6)	(7.4)	(7.4)	7.4	7.4	7.6	7.6	7.4	7.4	(7.2)	(7.0)	15.68	6.72		22.4	1
2 SULAWESI UTARA TEAM (CITRA, GABRIELA_MARIA, TESALONIKA_PRISCILIA_JULIA) (SULUT)	068 PAPUREN	(7.2)	(7.2)	7.2	(7.2)	(6.8)	(6.8)	(7.0)	7.2	(7.4)	7.2	7.2	(7.4)	7.2	7.2	15.12	6.48		21.6	4
3 SHOKAIDO TEAM (GHOLYAH, LAYLI_WILMA, NUR_RAFNI) (SHOKAIDO)	021 GOJUSHIHO SHO	(6.8)	6.8	(7.4)	(7.2)	7.0	7.0	(7.2)	(7.2)	(6.6)	(6.4)	7.2	7.2	6.8	(6.6)	14.7	6.3		21.0	6
4 GABDIKA TEAM (FAIRUZ_RAHMA, PUTRI_ALISHA, QOTHRUNNADA) (GABDIKA)	030 HEIKU	(7.0)	(6.8)	(7.2)	7.0	(7.2)	7.0	7.2	(7.2)	7.2	7.0	7.2	(7.4)	(7.0)	(6.6)	15.12	6.3		21.425	
5 INKAI TEAM (AJRIYA_NAJWAH, MALINI_ANGGA, NABILA_PUTRI) (INKAI)	020 GOJUSHIHO DAI	(7.6)	(7.6)	(7.2)	(7.2)	(7.6)	(7.4)	(7.4)	7.4	7.4	7.4	7.4	7.4	7.4	(7.2)	15.54	6.66		22.2	2
6 BKC TEAM (ASSYIFA_IZZATIL, CHAERUNISA_AINI, RATNA_ESYA) (BKC)	020 GOJUSHIHO DAI	(7.4)	(7.2)	(7.2)	(7.0)	(7.4)	7.2	(7.2)	(7.4)	7.2	(7.4)	7.4	7.2	7.4	7.4	15.26	6.54		21.8	3
7 LEMKARI TEAM (CINTA, MANDA_RIHADATUL, VINA) (LEMKARI)	015 GANKAKU	(6.6)	(6.6)	(6.8)	(6.8)	6.6	6.6	(6.8)	(6.8)	6.8	6.8	6.6	6.8	(6.4)	(6.2)	14.0	6.06		20.067	

R1 G2/2 (7) Tatami 2 17:05

Competitors	Kata	1T	1A	2T	2A	3T	3A	4T	4A	5T	5A	6T	6A	7T	7A	TEC	ATH	Extra	Total	Rank
1 JAKARTA TEAM (BEATRIEX_HELENA, SORA, ZAFIRA_ANGGRAINI) (JAKARTA)	030 HEIKU	(7.4)	(7.4)	7.4	(7.4)	(7.2)	(7.2)	(7.2)	(7.2)	7.4	7.4	7.2	7.4	(7.6)	7.4	15.4	6.66		22.062	
2 INKANAS TEAM (LAYLA_PUTRI, MEISYA, SYADZA_NAJLA) (INKANAS)	020 GOJUSHIHO DAI	(7.6)	(7.2)	(7.2)	(7.4)	7.4	7.4	7.4	7.4	7.6	7.4	(7.2)	(7.2)	(7.8)	(7.6)	15.68	6.66		22.341	
3 SHIROITE TEAM (ELIKHA_DAIYAFNI, KAVITA, MEILFIA_PUTRI) (SHIROITE)	047 KURURUNFA	(6.6)	(6.6)	(7.0)	6.8	7.0	6.8	(6.6)	(6.6)	7.0	6.8	6.8	(7.2)	(7.2)	(7.2)	14.56	6.12		20.686	
4 INKADO TEAM (MISCHA_GABRIELLA, RENATA_GLODY, SALMAH_AQILA) (INKADO)	066 PACHU	(6.8)	(6.8)	(6.8)	(6.8)	(7.4)	(7.2)	6.8	6.8	7.0	7.0	7.0	7.0	(7.2)	(7.4)	14.56	6.24		20.8	5
5 BALI TEAM (NI_KADEK_AYU, PUTRI_NATALIA, VEYORI_YELLA) (BALI)	041 KANKU SHO	(7.2)	(7.2)	7.2	7.2	7.2	(7.4)	(7.0)	(7.0)	(7.4)	7.2	7.2	(7.0)	(7.4)	7.2	15.12	6.48		21.6	3
6 BABEL TEAM (ELISABET, NAYLA_AURELIA, WIRENA) (BABEL)	041 KANKU SHO	(6.4)	(6.4)	6.4	6.4	(6.0)	(6.0)	6.4	6.4	(7.0)	(6.8)	6.6	(6.8)	(6.8)	6.8	13.58	5.88		19.467	
7 GOJUKAI TEAM (ANDITA_PUTRI, SITI, SYELLA) (GOJUKAI)	086 SEISAN	7.2	7.0	(7.0)	6.8	7.0	(7.2)	(6.6)	(6.4)	(7.4)	(7.2)	(7.4)	(6.6)	7.0	7.0	14.84	6.24		21.084	

R2-G1 Tatami 1 17:30

Competitors	Kata	1T	1A	2T	2A	3T	3A	4T	4A	5T	5A	6T	6A	7T	7A	TEC	ATH	Extra	Total	Rank
1 INKAI TEAM (AJRIYA_NAJWAH, MALINI_ANGGA, NABILA_PUTRI) (INKAI)	041 KANKU SHO	(7.6)	(7.4)	7.2	7.2	(7.0)	(7.0)	(7.6)	(7.4)	7.4	7.4	7.4	7.4	(7.0)	(7.0)	15.4	6.6		22.0	2
2 SULAWESI UTARA TEAM (CITRA, GABRIELA_MARIA, TESALONIKA_PRISCILIA_JULIA) (SULUT)	002 ANAN DAI	(7.4)	(7.2)	(7.2)	(7.0)	(6.8)	(6.8)	7.2	(7.2)	7.2	7.2	7.2	7.2	(7.0)	7.2	15.12	6.48		21.6	3
3 JABAR TEAM (HANA, IVANDA_LEONA, SITI) (JABAR)	020 GOJUSHIHO DAI	(7.4)	(7.4)	(7.4)	(7.2)	7.4	(7.4)	(7.6)	7.4	(7.6)	7.4	7.4	7.4	7.4	(7.2)	15.54	6.66		22.2	1
4 BKC TEAM (ASSYIFA_IZZATIL, CHAERUNISA_AINI, RATNA_ESYA) (BKC)	015 GANKAKU	(7.2)	7.2	7.0	(6.8)	(6.6)	(6.6)	7.2	7.0	(6.8)	6.8	7.2	(7.4)	(7.4)	(7.4)	14.98	6.3		21.284	

R2-G2 Tatami 2 17:35

Competitors	Kata	1T	1A	2T	2A	3T	3A	4T	4A	5T	5A	6T	6A	7T	7A	TEC	ATH	Extra	Total	Rank
1 BALI TEAM (NI_KADEK_AYU, PUTRI_NATALIA, VEYORI_YELLA) (BALI)	020 GOJUSHIHO DAI	(7.4)	(7.2)	(7.4)	7.2	7.4	(7.0)	(7.2)	7.2	(7.0)	(7.0)	7.2	7.2	7.2	(7.4)	15.26	6.48		21.743	
2 INKANAS TEAM (LAYLA_PUTRI, MEISYA, SYADZA_NAJLA) (INKANAS)	009 CHIBANA NO KUSHANKU	(7.2)	(7.0)	(7.8)	(7.6)	(7.2)	(7.2)	7.4	7.4	(7.6)	7.4	7.6	(7.6)	7.4	7.6	15.68	6.72		22.4	2
3 GOJUKAI TEAM (ANDITA_PUTRI, SITI, SYELLA) (GOJUKAI)	068 PAPUREN	(7.6)	(7.4)	(7.6)	(7.4)	(7.0)	(7.0)	7.2	(7.0)	7.4	7.4	7.0	7.2	(6.8)	7.0	15.12	6.48		21.6	4
4 JAKARTA TEAM (BEATRIEX_HELENA, SORA, ZAFIRA_ANGGRAINI) (JAKARTA)	001 ANAN	(7.4)	(7.4)	(7.8)	(8.0)	(7.4)	(7.4)	7.6	7.6	7.4	7.4	(7.8)	(7.8)	7.8	7.6	15.96	6.78		22.741	

R3 Bronze Medal Match 1 Tatami 1 17:50

Competitors	Kata	1T	1A	2T	2A	3T	3A	4T	4A	5T	5A	6T	6A	7T	7A	TEC	ATH	Extra	Total	Rank
1 INKAI TEAM (AJRIYA_NAJWAH, MALINI_ANGGA, NABILA_PUTRI) (INKAI)	099 UNSU	(7.4)	(7.4)	(7.6)	7.4	7.4	7.4	7.4	(7.0)	(7.2)	(7.2)	7.4	(7.6)	(7.2)	7.2	15.54	6.6		22.141	
2 BALI TEAM (NI_KADEK_AYU, PUTRI_NATALIA, VEYORI_YELLA) (BALI)	015 GANKAKU	(7.2)	7.2	(7.4)	7.2	(7.6)	(7.6)	(7.2)	(7.0)	7.4	(7.4)	7.2	(7.0)	7.2	7.2	15.26	6.48		21.742	

**KEJURNAS KARATE CADET, JUNIOR
& U21 TAHUN 2021 - 2021-11-05
JUNIOR KATA BEREGU PUTRI**









R3 Bronze Medal Match 2 Tatami 2 17:55

Competitors	Kata	1T	1A	2T	2A	3T	3A	4T	4A	5T	5A	6T	6A	7T	7A	TEC	ATH	Extra	Total	Rank
1 SULAWESI UTARA TEAM (CITRA, GABRIELA_MARIA, TESALONIKA_PRISCILIA_JULIA (SULUT)	047 KURURUNFA	(7.2)	(7.4)	7.2	(7.0)	(7.0)	(7.2)	(7.4)	7.2	7.2	7.2	(7.0)	(7.0)	7.2	7.2	15.12	6.48		21.6	2
2 INKANAS TEAM (LAYLA_PUTRI, MEISYA, SYADZA_NAJLA) (INKANAS)	099 UNSU	(7.6)	(7.6)	(7.4)	(7.4)	(7.4)	(7.4)	7.6	7.4	7.6	(7.6)	(7.8)	7.6	7.6	7.4	15.96	6.72		22.68	1

R3 Gold Medal Match Tatami 1 18:00

Competitors	Kata	1T	1A	2T	2A	3T	3A	4T	4A	5T	5A	6T	6A	7T	7A	TEC	ATH	Extra	Total	Rank
1 JABAR TEAM (HANA, IVANDA_LEONA, SITI) (JABAR)	099 UNSU	(7.4)	7.4	(7.0)	(7.0)	7.4	7.4	(7.8)	(7.8)	(7.8)	(7.6)	7.4	7.2	7.4	(7.0)	15.54	6.6		22.14	2
2 JAKARTA TEAM (BEATRIEX_HELENA, SORA, ZAFIRA_ANGGRAINI) (JAKARTA)	047 KURURUNFA	7.6	7.6	(7.4)	(7.2)	(7.8)	(7.8)	(8.0)	(7.8)	7.8	7.8	7.6	(7.4)	(7.4)	7.4	16.1	6.84		22.94	1

Results

1	JAKARTA TEAM - BEATRIEX_HELENA PANGEMANAN_GK - SORA AMANDA_GK - ZAFIRA_ANGGRAINI WIDODO_GK	DKI JAKARTA		INDONESIA
2	JABAR TEAM - IVANDA_LEONA PUTRI_TABITA_IN - SITI YASMIN_NUR_LATIFAH_IN - HANA ALIFAH_IN	JAWA BARAT		INDONESIA
3	INKAI TEAM - NABILA_PUTRI RAMADHANI - MALINI_ANGGA RESTA - AJRIYA_NAJWAH NURUL_AINI	INKAI		INDONESIA
3	INKANAS TEAM - LAYLA_PUTRI MAHARDIKA - SYADZA_NAJLA SYAKIRA - MEISYA RATU_C	INKANAS		INDONESIA
5	BALI TEAM - PUTRI_NATALIA DAMA - NI_KADEK_AYU SEPIANI_LK - VEYORI_YELLA SALIM	BALI		INDONESIA
5	SULAWESI UTARA TEAM - CITRA_C_MONTOLALU_GK - TESALONIKA_PRISCILIA_JULIA SIMBOH - GABRIELA_MARIA CLARA_MASA	SULAWESI UTARA		INDONESIA
7	BKC TEAM - RATNA_ESYA WULANDARI - ASSYIFA_IZZATIL ISMA - CHAERUNISA_AINI ZAHRA	BKC		INDONESIA
7	GOJUKAI TEAM - ANDITA_PUTRI QEYLA - SITI FARIDAH - SYELLA NOFITRIANA	GOJUKAI		INDONESIA

**KEJURNAS KARATE CADET, JUNIOR
& U21 TAHUN 2021 - 2021-11-05
JUNIOR KATA PERORANGAN PUTRA**

R1 G1/4 (8) Tatami 3 11:05

Competitors	Kata	1T	1A	2T	2A	3T	3A	4T	4A	5T	5A	6T	6A	7T	7A	TEC	ATH	Extra	Total	Rank
1 ANDIKA PRASETYA_PW (PORBIKAWA)	078 SANSAI	(7.0)	7.4	7.0	7.0	(6.6)	(6.8)	(7.6)	(7.6)	7.0	7.4	(7.4)	(7.6)	7.0	(6.8)	14.7	6.54		21.245	
2 ANAK_AGUNG GEDE_WIRYANANTHA_IS (BALI)	099 UNSU	(7.0)	(7.0)	7.2	7.2	(6.8)	(7.0)	(7.8)	(7.8)	(7.4)	(7.4)	7.4	7.4	7.4	7.4	15.4	6.6		22.0	2
3 JUANDI_F NINO-IN (NTT)	041 KANKU SHO	(6.4)	6.8	(6.8)	6.8	(6.6)	(6.6)	(7.0)	(7.0)	6.6	(7.2)	6.6	6.8	6.6	(6.6)	13.86	6.12		19.988	
4 HAZEL RAMADHAN (JABAR)	099 UNSU	(7.4)	(7.6)	7.6	7.6	(7.8)	(7.8)	(7.4)	(7.4)	7.4	7.6	(8.0)	(8.0)	7.6	7.6	15.82	6.84		22.661	
5 DISMA_SANG WISANGGABHUMI (KALTIM)	021 GOJUSHIHO SHO	7.2	7.2	7.2	(7.4)	7.2	7.2	(7.4)	(7.4)	(6.8)	(7.0)	(7.4)	7.4	(7.0)	(7.0)	15.12	6.54		21.663	
6 MARKO_ADIPUTRA WULUR_ (GABDIKA)	008 CHATANYARA KUSHANKU	(7.0)	(7.2)	(7.2)	(7.0)	(7.0)	7.2	(7.2)	7.2	7.2	(7.6)	7.2	(7.0)	7.2	7.2	15.12	6.48		21.6	4
7 ARYADINATA ARBIE_ (SULUT)	002 ANAN DAI	(6.8)	6.6	(7.4)	(7.4)	6.8	(6.8)	6.8	6.6	6.6	6.8	(6.2)	(6.2)	(6.4)	(6.4)	14.14	6.0		20.147	
8 RASIKH_FAROOQ ARDRA (GOKASI)	092 SUPARINPEI	(7.2)	(6.8)	(7.0)	(7.2)	7.0	(7.0)	(6.8)	(6.8)	7.0	6.8	(7.2)	7.0	7.2	7.0	14.84	6.24		21.086	

R1 G2/4 (7) Tatami 3 13:00

Competitors	Kata	1T	1A	2T	2A	3T	3A	4T	4A	5T	5A	6T	6A	7T	7A	TEC	ATH	Extra	Total	Rank
1 MUAMMAR QADAFI_ (INKAI)	099 UNSU	(7.4)	7.4	(7.8)	(7.8)	7.4	(7.2)	(7.6)	7.4	7.4	7.2	(7.0)	(6.8)	7.6	(7.6)	15.68	6.6		22.283	
2 MUHAMMAD REZA_NASUTION_SR (SHIROITE)	008 CHATANYARA KUSHANKU	(7.6)	(7.6)	6.8	6.8	(6.6)	(6.4)	(7.0)	6.8	7.0	(6.6)	(6.6)	6.6	7.0	(7.0)	14.56	6.06		20.627	
3 NABIL_AZZURA ASSIRIN_ (SUMBAR)	099 UNSU	(7.2)	(7.2)	(7.4)	(7.4)	(6.4)	(6.2)	7.2	7.2	7.0	6.8	(6.4)	(6.2)	7.2	7.2	14.98	6.36		21.346	
4 WILLIAM WINENGO_IS (SULSEL)	078 SANSAI	(7.2)	(7.0)	(7.6)	(7.6)	(7.6)	(7.4)	7.4	7.4	7.4	(7.0)	(7.2)	7.0	7.4	7.2	15.54	6.48		22.024	
5 MUHAMMAD YUSUF_SYAHADAN (INKADO)	021 GOJUSHIHO SHO	(7.4)	(7.0)	7.6	(7.6)	(7.8)	7.4	(7.8)	(7.6)	7.4	(7.2)	7.4	7.4	(7.2)	7.4	15.68	6.66		22.342	
6 LALU MUHAMAD_FIRAS_IS (NTB)	021 GOJUSHIHO SHO	7.2	(7.4)	(7.6)	(7.8)	(7.0)	(6.8)	(7.4)	(7.2)	7.4	7.2	(7.0)	7.2	7.4	7.4	15.4	6.54		21.945	
7 CHRISTOPHER EDBERT_S_SI (JATENG)	064 OHAN DAI	(7.6)	(7.4)	(8.0)	(8.0)	(8.0)	7.8	(7.6)	7.6	7.6	7.6	(7.4)	8.0	(8.0)		16.24	6.9		23.141	

R1 G3/4 (7) Tatami 4 10:55

Competitors	Kata	1T	1A	2T	2A	3T	3A	4T	4A	5T	5A	6T	6A	7T	7A	TEC	ATH	Extra	Total	Rank
1 LAURENTIUS_ARYA PANDHITA_WICAKSANA (DIY)	047 KURURUNFA	(7.2)	(7.4)	(6.8)	(6.8)	(6.8)	(6.6)	(7.4)	(7.2)	7.0	7.0	6.8	7.2	7.2	7.0	14.7	6.36		21.067	
2 ALVITO_ABHISTA PANGESTU (BUDOKAI)	068 PAPUREN	7.4	(7.2)	(7.2)	7.2	(7.0)	(6.6)	7.4	7.4	(7.8)	(8.0)	(7.6)	(7.6)	7.4	7.4	15.54	6.6		22.144	
3 YUDA MANOGI_PURBA (SUMUT)	002 ANAN DAI	(7.0)	7.2	(7.6)	(7.4)	(7.2)	(6.8)	7.6	7.4	(8.0)	(8.0)	7.4	(7.0)	7.4	7.2	15.68	6.54		22.222	
4 FIRMAN MAULANA (INKANAS)	002 ANAN DAI	(7.4)	7.6	(7.8)	7.6	(7.6)	(7.4)	7.6	(7.4)	(8.0)	(8.2)	7.6	(7.8)	7.8	7.6	16.1	6.84		22.941	
5 RYU RIVALDI (KALBAR)	002 ANAN DAI	7.2	(7.2)	(7.6)	(7.6)	(7.4)	7.2	(7.0)	(6.8)	7.4	(7.6)	(7.0)	7.2	7.0	7.2	15.12	6.48		21.6	6
6 MOCHAMAD NALENDRA_BUANA (FUNAKOSHI)	009 CHIBANA NO KUSHANKU	(7.2)	(7.0)	(7.4)	(7.4)	7.4	(7.0)	(7.6)	7.4	7.4	(7.6)	(6.8)	7.2	7.2	7.2	15.4	6.54		21.945	
7 MOCHAMAD_FAJAR FEBRIAN_DJUNAIDI_IN (JAKARTA)	099 UNSU	7.4	(7.6)	(7.6)	7.6	(6.8)	(7.0)	7.2	7.4	(7.6)	(7.8)	(7.0)	(7.0)	7.4	7.6	15.4	6.78		22.183	

R1 G4/4 (7) Tatami 4 13:00

Competitors	Kata	1T	1A	2T	2A	3T	3A	4T	4A	5T	5A	6T	6A	7T	7A	TEC	ATH	Extra	Total	Rank
1 GIZAN SABYANTARA (LEMKARI)	015 GANKAKU	(7.0)	(7.0)	(7.0)	(7.0)	7.2	7.2	7.4	7.4	7.4	(7.6)	(7.6)	(7.8)	(7.8)	7.6	15.4	6.66		22.063	
2 M_IKRAM NAZARIANTO (KEISHINKAN)	009 CHIBANA NO KUSHANKU	(7.0)	7.2	7.2	7.2	(7.0)	(7.0)	(7.4)	(7.4)	(7.4)	(8.0)	(8.0)	7.4	7.4		15.26	6.54		21.8	5
3 MULKI_JP ASNAWI (GOJUKAI)	092 SUPARINPEI	(7.4)	(7.4)	7.4	(7.4)	(7.6)	7.4	7.6	7.4	7.6	7.4	(7.8)	(7.8)	(7.2)	(7.0)	15.82	6.66		22.481	
4 GHOFAR SYAHFRI_HUDZAIIFI (GOJU ASS)	068 PAPUREN	(7.2)	(7.4)	(7.6)	(7.4)	(7.2)	(7.2)	7.2	(7.2)	7.2	7.4	7.4	(7.6)	7.4	7.4	15.26	6.66		21.924	
5 AH DAN_AZMI ALFARITSI_ (BKC)	041 KANKU SHO	(6.8)	7.0	7.2	7.0	(7.4)	(7.4)	(7.4)	7.2	7.2	(7.4)	(6.8)	(6.8)	7.0	(6.8)	14.98	6.36		21.347	
6 GANDI_DARMA PRATAMA (SHOTOKAI)	099 UNSU	(7.0)	7.4	(7.6)	(7.6)	7.2	7.4	7.2	(7.0)	7.6	7.6	(7.0)	(7.0)	(7.8)	(7.8)	15.4	6.72		22.122	
7 MUH_ARAFAT_SABIR_M (SULTRA)	099 UNSU	(7.2)	(7.0)	(6.8)	7.0	(7.0)	(6.8)	7.0	7.0	7.2	(7.4)	7.2	7.2	(7.4)	(7.4)	14.98	6.36		21.346	

R2-G1 Tatami 3 13:40

Competitors	Kata	1T	1A	2T	2A	3T	3A	4T	4A	5T	5A	6T	6A	7T	7A	TEC	ATH	Extra	Total	Rank
1 MUHAMMAD YUSUF_SYAHADAN (INKADO)	041 KANKU SHO	(7.2)	(7.4)	(7.8)	(7.8)	7.4	(7.4)	7.6	7.6	(7.8)	(7.8)	7.6	7.4	(6.8)	7.4	15.82	6.72		22.543	
2 DISMA_SANG WISANGGABHUMI (KALTIM)	015 GANKAKU	7.4	(7.2)	7.4	(7.4)	(7.6)	7.4	(7.6)	7.4	(7.2)	7.2	7.4	(7.0)	(7.2)	(7.6)	15.54	6.6		22.145	
3 ANAK_AGUNG GEDE_WIRYANANTHA_IS (BALI)	002 ANAN DAI	(7.6)	(7.6)	(7.2)	(7.2)	(7.2)	7.4	(7.6)	(7.8)	7.4	7.4	7.2	(6.8)	7.4	7.4	15.4	6.66		22.066	
4 CHRISTOPHER EDBERT_S_SI (JATENG)	002 ANAN DAI	(8.0)	(7.8)	(7.6)	(7.8)	(7.8)	7.8	(8.2)	(8.2)	8.0	7.8	8.0	7.8	7.8	(7.6)	16.66	7.02		23.681	
5 HAZEL RAMADHAN (JABAR)	002 ANAN DAI	7.8	(7.6)	(8.0)	(7.8)	(7.4)	7.6	(8.0)	(8.0)	7.6	7.8	7.8	(7.4)	(7.4)	7.6	16.24	6.9		23.142	
6 MARKO_ADIPUTRA WULUR_ (GABDIKA)	068 PAPUREN	(7.4)	(7.4)	(7.2)	(7.4)	7.2	7.4	(7.6)	(7.8)	7.4	7.4	(6.8)	(6.4)	7.2	7.4	15.26	6.66		21.927	
7 WILLIAM WINENGO_IS (SULSEL)	064 OHAN DAI	(7.2)	(7.0)	7.4	(7.6)	7.2	7.2	(7.6)	(8.0)	(7.6)	7.6	7.2	(7.0)	(6.8)	7.4	15.26	6.66		21.928	
8 MUAMMAR QADAFI_ (INKAI)	021 GOJUSHIHO SHO	(7.2)	(7.2)	(7.6)	(7.6)	(7.4)	7.6	(8.0)	(8.2)	7.4	7.2	7.4	(7.0)	7.4	7.4	15.54	6.66		22.2	4

R2-G2 Tatami 4 13:40

Competitors	Kata	1T	1A	2T	2A	3T	3A	4T	4A	5T	5A	6T	6A	7T	7A	TEC	ATH	Extra	Total	Rank
1 MOCHAMAD_FAJAR FEBRIAN_DJUNAIDI_IN (JAKARTA)	001 ANAN	(7.4)	(7.4)	7.4	(7.2)	(7.2)	7.4	(7.2)	(7.0)	7.2	7.2	(7.6)	(7.8)	7.4	7.2	15.4	6.54		21.947	

**KEJURNAS KARATE CADET, JUNIOR
& U21 TAHUN 2021 - 2021-11-05
JUNIOR KATA PERORANGAN PUTRA**

2	ALVITO_ABHISTA PANGESTU (BUDOKAI)	064 OHAN DAI	(7.2)	(7.2)	(7.6)	7.4	7.4	(7.6)	7.6	7.2	(7.0)	(7.0)	7.4	7.4	(7.8)	(7.8)	15.68	6.6		22.28	3
3	GANDI_DARMA PRATAMA (SHOTOKAI)	078 SANSAI	(7.2)	(7.4)	7.4	(7.4)	(8.0)	(7.8)	7.8	7.4	7.4	(8.0)	(7.8)	(7.2)	7.6	15.82	6.72		22.54	2	
4	GHOFAH SYAHFRI_HUDZAIFI (GOJU ASS)	002 ANAN DAI	(7.4)	(7.6)	7.2	(7.4)	(7.0)	7.4	(7.4)	(7.0)	7.2	7.4	7.4	(6.8)	(7.2)	15.26	6.66		21.92	8	
5	GIZAN SABYANTARA (LEMKARI)	099 UNSU	(7.6)	(7.6)	7.4	7.2	(7.6)	(7.4)	(7.2)	(6.8)	(7.0)	7.2	7.2	7.4	(7.0)	15.4	6.54		21.94	6	
6	FIRMAN MAULANA (INKANAS)	064 OHAN DAI	(7.4)	(7.8)	(7.8)	7.8	7.8	7.6	(7.2)	(7.2)	7.4	(7.4)	(8.2)	(8.2)	7.6	7.8	15.96	6.96		22.92	1
7	YUDA MANOGI_PURBA (SUMUT)	092 SUPARINPEI	(7.0)	(7.2)	(7.6)	(7.6)	7.4	7.2	7.4	7.2	7.4	7.4	(7.8)	(7.8)	(7.0)	(6.8)	15.54	6.54		22.08	5
8	MULKI_JP ASNAWI (GOJUKAI)	008 CHATANYARA KUSHANKU	(7.2)	(7.4)	(7.6)	7.4	7.4	(7.6)	7.4	(7.2)	(7.6)	7.4	7.4	(7.0)	(7.6)	15.54	6.66		22.2	4	

R3-G1 Tatami 3 14:10

Competitors	Kata	1T	1A	2T	2A	3T	3A	4T	4A	5T	5A	6T	6A	7T	7A	TEC	ATH	Extra	Total	Rank
1 CHRISTOPHER EDBERT_S_SI (JATENG)	092 SUPARINPEI	7.8	(8.0)	(7.6)	(7.6)	(8.2)	(8.0)	7.6	7.8	(7.4)	(7.6)	(8.0)	8.0	7.6	7.6	16.1	7.02		23.12	2
2 HAZEL RAMADHAN (JABAR)	064 OHAN DAI	(8.2)	(8.2)	8.0	(7.8)	(8.4)	(8.0)	(7.4)	(7.6)	(7.8)	8.0	7.8	8.0	7.8	7.8	16.52	7.14		23.66	1
3 MUHAMMAD YUSUF_SYAHADAN (INKADO)	099 UNSU	(7.6)	(7.6)	(7.4)	(7.2)	(7.2)	(7.0)	7.4	(7.4)	7.4	7.4	7.4	7.4	(7.6)	7.4	15.54	6.66		22.2	3
4 MUAMMAR QADAFI_ (INKAI)	015 GANKAKU	(7.4)	(7.2)	(7.4)	(7.2)	7.4	7.2	7.4	7.2	(7.2)	7.2	(7.8)	(7.8)	7.4	(7.4)	15.54	6.48		22.02	4

R3-G2 Tatami 4 14:10

Competitors	Kata	1T	1A	2T	2A	3T	3A	4T	4A	5T	5A	6T	6A	7T	7A	TEC	ATH	Extra	Total	Rank
1 ALVITO_ABHISTA PANGESTU (BUDOKAI)	092 SUPARINPEI	(7.2)	(7.4)	(7.0)	(7.0)	(7.4)	(7.2)	7.4	(7.4)	(7.6)	7.4	7.4	7.2	7.2	7.4	15.4	6.6		22.0	4
2 GANDI_DARMA PRATAMA (SHOTOKAI)	092 SUPARINPEI	7.6	(7.4)	(7.4)	(7.2)	(7.4)	7.6	(8.0)	(8.0)	(8.2)	(8.0)	7.8	7.4	7.4	7.6	15.96	6.78		22.74	1
3 MULKI_JP ASNAWI (GOJUKAI)	002 ANAN DAI	7.4	(7.4)	(7.6)	(7.8)	(7.2)	7.4	(7.2)	(7.2)	(7.6)	7.4	7.4	(7.0)	7.4	7.2	15.54	6.6		22.14	3
4 FIRMAN MAULANA (INKANAS)	009 CHIBANA NO KUSHANKU	7.6	7.4	(7.8)	(7.8)	(7.8)	(7.6)	(7.0)	(7.0)	7.6	7.6	(7.2)	(7.2)	7.4	7.4	15.82	6.72		22.54	2

R4 Bronze Medal Match 1 Tatami 3 14:25

Competitors	Kata	1T	1A	2T	2A	3T	3A	4T	4A	5T	5A	6T	6A	7T	7A	TEC	ATH	Extra	Total	Rank
1 CHRISTOPHER EDBERT_S_SI (JATENG)	008 CHATANYARA KUSHANKU	(8.4)	(8.0)	(7.4)	(7.6)	7.8	7.8	(8.0)	(8.0)	(7.6)	7.6	8.0	8.0	7.6	(7.4)	16.38	7.02		23.4	1
2 MULKI_JP ASNAWI (GOJUKAI)	064 OHAN DAI	(8.0)	(7.8)	7.6	7.6	7.6	7.6	(7.8)	(7.8)	(7.4)	7.4	7.6	(7.2)	(7.2)	(7.2)	15.96	6.78		22.74	2







R4 Bronze Medal Match 2 Tatami 4 14:25

Competitors	Kata	1T	1A	2T	2A	3T	3A	4T	4A	5T	5A	6T	6A	7T	7A	TEC	ATH	Extra	Total	Rank
1 MUHAMMAD YUSUF_SYAHADAN (INKADO)	015 GANKAKU	(7.4)	7.4	7.4	(7.2)	(7.8)	(8.0)	(7.2)	(7.2)	7.6	7.6	(8.2)	(8.0)	7.4	7.2	15.68	6.66		22.34	2
2 FIRMAN MAULANA (INKANAS)	078 SANSAI	(7.4)	(7.6)	7.8	(7.4)	(8.2)	(8.2)	(7.6)	7.6	(8.0)	(8.0)	7.8	8.0	7.8	7.6	16.38	6.96		23.34	1

R4 Gold Medal Match Tatami 3 14:35

Competitors	Kata	1T	1A	2T	2A	3T	3A	4T	4A	5T	5A	6T	6A	7T	7A	TEC	ATH	Extra	Total	Rank
1 HAZEL RAMADHAN (JABAR)	068 PAPUREN	(8.2)	(8.2)	(8.4)	(8.4)	8.2	8.0	8.0	8.0	8.2	8.2	(7.8)	(7.8)	(7.8)	(7.8)	17.08	7.26		24.34	1
2 GANDI_DARMA PRATAMA (SHOTOKAI)	015 GANKAKU	7.8	(7.8)	(8.2)	(8.2)	7.6	(7.4)	(7.4)	(7.4)	(8.0)	7.8	(7.4)	7.4	7.4	7.6	15.96	6.84		22.8	2

Results

1	HAZEL RAMADHAN	JAWA BARAT		INDONESIA
2	GANDI DARMA PRATAMA	SHOTOKAI		INDONESIA
3	CHRISTOPHER EDBERT S SI	JAWA TENGAH		INDONESIA
3	FIRMAN MAULANA	INKANAS		INDONESIA
5	MULKI JP ASNAWI	GOJUKAI		INDONESIA
5	MUHAMMAD YUSUF SYAHADAN	INKADO		INDONESIA
7	MUAMMAR QADAFI	INKAI		INDONESIA
7	ALVITO ABHISTA PANGESTU	BUDOKAI		INDONESIA

**KEJURNAS KARATE CADET, JUNIOR
& U21 TAHUN 2021 - 2021-11-05
JUNIOR KATA PERORANGAN PUTRI**

R1 G1/4 (9) Tatami 1 11:05

Competitors	Kata	1T	1A	2T	2A	3T	3A	4T	4A	5T	5A	6T	6A	7T	7A	TEC	ATH	Extra	Total Rank	
1 LALA DIAH_PITALOKA_IN (JABAR)	002 ANAN DAI	(7.0)	(7.0)	(8.0)	7.6	7.8	(7.8)	7.8	(7.8)	7.8	(8.0)	7.8	(7.6)	(7.4)	16.38	6.96		23.2	2	
2 NURLAHIZ_YUMNA ARIBA (SULTRA)	041 KANKU SHO	(6.2)	(6.2)	(7.6)	(7.2)	(7.2)	(7.2)	7.2	7.0	7.2	7.0	7.2	7.0	(6.8)	(6.6)	15.12	6.3		21.42	5
3 NIA POPDANAWATI (WADOKAI)	011 CHINTO	(6.0)	(5.8)	(7.0)	6.4	6.8	(6.8)	(6.2)	6.4	6.2	(6.0)	(7.0)	(6.8)	6.2	6.2	13.44	5.7		19.14	9
4 CINTA HADMAR (LEMKARI)	021 GOJUSHIHO SHO	(6.0)	(5.8)	7.2	6.8	6.6	6.8	(7.4)	(7.4)	(6.2)	(6.2)	(7.4)	(7.2)	6.4	6.4	14.14	6.0		20.14	8
5 NATASHA PRIACILIA (GOKASI)	092 SUPARINPEI	(6.6)	(6.6)	(7.4)	7.0	(6.8)	(6.4)	7.0	6.8	(7.2)	(7.2)	7.2	(7.2)	7.0	7.0	14.84	6.24		21.08	7
6 HERLIYANA PERTIWI_GS (BABEL)	009 CHIBANA NO KUSHANKU	(6.8)	(6.6)	(7.6)	(7.0)	7.4	7.2	(7.2)	7.2	7.4	(7.4)	(7.6)	(7.4)	7.4	7.2	15.54	6.48		22.02	2
7 ANNISA_OZORA HIMMATANA_AS (ASKI)	068 PAPUREN	(6.6)	(6.8)	(7.6)	7.2	7.2	7.2	(6.8)	(6.8)	7.4	7.2	7.6	(7.6)	(7.8)	(7.8)	15.54	6.48		22.02	3
8 FATHIRIA_SABIKA NURHALIZA_IS (DIY)	099 UNSU	(6.6)	(6.6)	(7.8)	(7.4)	7.0	6.8	(6.6)	(6.6)	7.2	7.0	7.4	7.4	(8.0)	(8.0)	15.12	6.36		21.48	4
9 ZAHRA_SHAFAA_NOORFAJR HAYYAN (GOJU ASS)	047 KURURUNFA	(6.8)	(6.4)	(7.4)	(7.0)	(7.0)	7.0	7.2	7.0	7.0	7.0	(7.4)	(7.4)	7.4	(7.2)	15.12	6.3		21.42	6

R1 G2/4 (9) Tatami 1 13:00

Competitors	Kata	1T	1A	2T	2A	3T	3A	4T	4A	5T	5A	6T	6A	7T	7A	TEC	ATH	Extra	Total Rank	
1 NABILA_PUTRI RAMADHANI (INKAI)	041 KANKU SHO	(8.2)	(8.0)	(7.8)	(7.8)	(7.0)	(7.0)	7.8	7.8	7.8	(7.6)	(7.6)	7.6	7.6	7.8	16.24	6.96		23.2	2
2 SALMA ZULFA_NUR_HABIBAH (FUNAKOSHI)	068 PAPUREN	(7.6)	(7.2)	(7.4)	(7.4)	(7.2)	(7.2)	7.4	7.2	7.4	7.2	(7.2)	7.2	7.4	(7.6)	15.54	6.48		22.02	5
3 ANANDHITA_MUTHIA ZAHARA_GK (SULSEL)	068 PAPUREN	(7.8)	7.4	(7.2)	7.4	(7.0)	(6.8)	7.6	7.4	(7.8)	(7.8)	7.4	(7.2)	7.8	(7.8)	15.96	6.66		22.62	3
4 ASTRI ALVIA_SO (RIAU)	099 UNSU	(7.6)	(7.4)	(7.0)	(6.8)	(6.8)	(6.8)	(7.4)	(7.4)	7.2	7.2	7.0	7.0	7.2	7.2	14.98	6.42		21.4	8
5 IRSA ALAMANDA_PUTRI_SI (SHINDOKA)	068 PAPUREN	(7.4)	(7.2)	(7.2)	(7.4)	(7.4)	(7.2)	(7.2)	7.2	7.4	7.2	7.2	(7.4)	7.4	7.4	15.4	6.54		21.94	7
6 FADHILA NASHWA_HAFIZA PERMANA (INKADO)	021 GOJUSHIHO SHO	(7.6)	(7.2)	7.4	7.2	7.6	7.2	(7.2)	(7.0)	(7.8)	(7.6)	(7.2)	7.2	7.2	(7.4)	15.54	6.48		22.02	6
7 RR_HAZIMA_ZAVIER NOOR_GK (JATIM)																				
8 AGHNIYA ZAMZAMI (INKANAS)	068 PAPUREN	(7.8)	(8.0)	(8.0)	(8.0)	7.8	(7.6)	7.8	(7.6)	(7.6)	7.6	7.8	7.6	(7.6)	7.8	16.38	6.9		23.28	1
9 INDAKA MAULAICA (BALI)	015 GANKAKU	(7.4)	(7.2)	(7.6)	7.4	7.4	7.4	7.4	(7.2)	(7.8)	(7.8)	7.6	(7.8)	(7.2)	7.4	15.68	6.66		22.34	4

R1 G3/4 (9) Tatami 2 10:55

Competitors	Kata	1T	1A	2T	2A	3T	3A	4T	4A	5T	5A	6T	6A	7T	7A	TEC	ATH	Extra	Total Rank	
1 BEATRIEX_HELENA PANGEMANAN_GK (JAKARTA)	001 ANAN	(7.4)	(7.6)	7.4	(7.6)	(7.6)	7.4	7.4	(7.2)	(7.2)	7.2	7.4	7.2	(6.8)	(7.0)	15.54	6.54		22.08	1
2 GHOLIAH PUTERI_VIRGIE_SK (SHOKAIDO)	019 GOJUSHIHO	7.0	(7.0)	(6.8)	(7.0)	(7.2)	7.0	(6.8)	(6.8)	7.0	7.0	(7.2)	7.0	6.8	(6.8)	14.56	6.3		20.86	7
3 CINTA MUAYA (SULUT)	068 PAPUREN	(7.0)	(6.8)	7.2	(7.2)	(7.4)	7.2	7.2	7.0	7.2	(7.4)	(7.4)	7.2	(6.8)	(6.8)	15.12	6.42		21.54	2
4 REVANIDA_SUKMA WIDI (BKC)	015 GANKAKU	(7.2)	(7.2)	(7.0)	(7.2)	7.2	7.2	(7.0)	(7.0)	7.0	7.2	7.2	(7.0)	(7.4)	7.2	14.98	6.48		21.46	3
5 FADILLAH_PUSPITA SARI (KEISHINKAN)	047 KURURUNFA	(7.4)	(7.4)	7.0	(6.8)	7.0	7.0	(6.8)	7.0	(6.8)	(6.8)	(7.2)	(7.2)	7.0	7.0	14.7	6.3		21.0	6
6 ADINDA_APRILYAH PUTRI (SUMSEL)																				
7 QURUTUL_AINIRZIKY_BC (JATENG)	021 GOJUSHIHO SHO	(7.0)	(7.2)	7.0	(7.0)	7.0	7.2	(7.2)	7.2	(7.2)	(7.4)	7.0	(6.8)	(6.8)	7.0	14.7	6.42		21.12	5
8 INDAH FEBRIYANI_GK (LAMPUNG)	008 CHATANYARA KUSHANKU	(7.4)	(7.4)	(7.4)	(7.4)	7.2	(7.2)	7.0	7.2	7.0	7.4	(6.8)	(6.6)	(6.8)	7.2	14.84	6.54		21.38	4
9 MEGA_PERMATA SARI_MAJID (PAPUA)	021 GOJUSHIHO SHO	6.4	6.4	6.4	6.4	(6.8)	(6.8)	(6.2)	(6.0)	(6.0)	(6.0)	(6.6)	(6.6)	6.4	6.6	13.44	5.82		19.26	8

R1 G4/4 (8) Tatami 2 13:00

Competitors	Kata	1T	1A	2T	2A	3T	3A	4T	4A	5T	5A	6T	6A	7T	7A	TEC	ATH	Extra	Total Rank	
1 HANY_AMALIA EKO_PUTRI_SR (SHIROITE)	021 GOJUSHIHO SHO	6.2	(6.4)	(6.0)	6.2	(6.6)	(6.4)	(6.4)	6.2	6.2	6.2	(6.0)	(5.8)	6.0	(5.8)	12.88	5.58		18.46	9
2 I_GUSTI_AGUNG_KETUT ADINDA_BELIA (BANTEN)	002 ANAN DAI	(7.0)	(7.0)	(7.2)	(7.0)	7.2	7.0	7.2	7.2	7.2	(7.4)	(7.4)	7.2	(7.4)	(7.6)	15.12	6.42		21.54	2
3 SHOVIOLA AYUMMI (SUMBAR)	015 GANKAKU	(7.0)	(7.2)	(6.8)	(6.6)	(6.8)	(6.6)	(7.4)	(7.2)	6.8	6.8	7.0	7.2	6.8	7.0	14.42	6.3		20.72	6
4 SONYA_AULIA NINGRUM (NTB)	002 ANAN DAI	(7.4)	(7.4)	7.0	(6.6)	(6.8)	7.0	(7.4)	(7.4)	7.4	7.4	7.4	7.4	(6.8)	(6.8)	15.26	6.54		21.8	2
5 SONYA_M PUAY-IN (NTT)	021 GOJUSHIHO SHO	7.0	(7.2)	(6.0)	(6.4)	(6.6)	(6.4)	(7.2)	7.0	6.8	7.2	6.6	6.6	(7.2)	(7.4)	14.28	6.24		20.52	7
6 ANDI_CHESARIA N (GABDIKA)	061 NIPAPO	(7.0)	7.0	(7.0)	7.0	7.0	(6.8)	(7.4)	(7.2)	7.0	(7.2)	7.0	(6.8)	(7.2)	7.0	14.7	6.3		21.0	5
7 SYELLA NOFITRIANA (GOJUKAI)	068 PAPUREN	(7.2)	(7.2)	(7.4)	7.2	(7.4)	7.2	(7.2)	(7.0)	7.2	(7.0)	7.2	7.0	7.4	(7.6)	15.26	6.42		21.68	3
8 INDIRA_MAUREEN RHEIFA_WIBOWO_IS (JATIM)	001 ANAN	(7.4)	(7.4)	7.4	(7.4)	(7.6)	(7.4)	(7.6)	7.4	7.4	7.4	7.4	(7.2)	(7.2)	7.4	15.54	6.66		22.2	1

R2-G1 Tatami 1 13:55

Competitors	Kata	1T	1A	2T	2A	3T	3A	4T	4A	5T	5A	6T	6A	7T	7A	TEC	ATH	Extra	Total Rank	
1 ANANDHITA_MUTHIA ZAHARA_GK (SULSEL)	009 CHIBANA NO KUSHANKU	(7.2)	(7.2)	(7.2)	(7.2)	7.6	(7.4)	7.6	7.4	(7.8)	7.4	(7.8)	(7.6)	7.4	7.4	15.82	6.66		22.48	5
2 HERLIYANA PERTIWI_GS (BABEL)	092 SUPARINPEI	(7.4)	7.4	(7.4)	(7.2)	(7.6)	(7.6)	7.4	7.4	(7.6)	(7.2)	7.6	(7.8)	7.4	7.2	15.68	6.6		22.28	6
3 AGHNIYA ZAMZAMI (INKANAS)	002 ANAN DAI	(7.8)	(7.6)	(7.4)	(7.2)	(7.8)	(7.4)	(7.2)	7.4	7.6	7.6	7.8	(7.8)	7.6	7.4	16.1	6.72		22.82	3
4 FATHIRIA_SABIKA NURHALIZA_IS (DIY)	068 PAPUREN	(6.8)	(7.0)	(7.6)	(7.4)	(7.2)	(6.8)	7.2	7.2	7.4	7.0	(7.6)	(7.6)	7.4	7.0	15.4	6.36		21.76	7
5 ANNISA_OZORA HIMMATANA_AS (ASKI)	066 PACHU	(6.6)	(6.6)	7.2	7.0	7.2	(7.2)	(7.0)	(7.2)	(7.4)	(6.6)	(7.4)	7.0	7.0	6.8	14.98	6.24		21.22	8

**KEJURNAS KARATE CADET, JUNIOR
& U21 TAHUN 2021 - 2021-11-05
JUNIOR KATA PERORANGAN PUTRI**

6	LALA DIAH_PITALOKA_IN (JABAR)	099 UNSU	(8.0)	(8.0)	(7.8)	(7.8)	(7.8)	(7.6)	7.8	(7.6)	7.8	7.6	(8.0)	7.8	7.6	16.38	6.9	23.28	1	
7	NABILA_PUTRI RAMADHANI (INKAI)	020 GOJUSHIHO DAI	(7.8)	(8.0)	(7.8)	(7.8)	(7.6)	(7.6)	7.6	7.8	7.8	7.8	(7.2)	(7.0)	7.8	7.8	16.24	7.02	23.26	2
8	INDAKA MAULAICA (BALI)	020 GOJUSHIHO DAI	(7.4)	(7.6)	(7.8)	(7.8)	(7.8)	(7.4)	(7.4)	7.6	7.6	7.6	7.6	(7.4)	7.4	7.6	15.82	6.84	22.66	4

R2-G2 Tatami 2 13:55

Competitors	Kata	1T	1A	2T	2A	3T	3A	4T	4A	5T	5A	6T	6A	7T	7A	TEC	ATH	Extra	Total Rank	
1 INDAH FEBRIYANI_GK (LAMPUNG)	002 ANAN DAI	(7.6)	(7.6)	(7.0)	(7.2)	(7.0)	(7.2)	(7.4)	(7.6)	7.4	7.6	7.2	7.2	7.2	7.4	15.26	6.66		21.92	3
2 CINTA MUAYA (SULUT)	092 SUPARINPEI	(7.0)	(7.0)	7.2	(7.2)	7.2	7.2	(7.4)	7.2	7.2	7.2	(7.4)	(7.4)	(6.8)	(7.0)	15.12	6.48		21.6	6
3 REVANIDA_SUKMA WIDI (BKC)	078 SANSAL	(7.2)	7.2	7.4	(7.4)	7.4	(7.0)	(7.6)	7.4	(7.6)	(7.6)	(7.2)	7.2	(7.0)		15.4	6.54		21.94	2
4 SYELLA NOFITRIANA (GOJUKAI)	047 KURURUNFA	(7.2)	(7.0)	(7.2)	(7.4)	(7.4)	(7.2)	7.2	(7.0)	7.2	7.2	7.2	7.0	(7.0)	7.0	15.12	6.36		21.48	8
5 INDIRA_MAUREEN RHEIFA_WIBOWO_IS (JATIM)	002 ANAN DAI	(7.4)	(7.2)	(7.2)	(7.0)	(7.6)	(7.4)	7.4	7.2	7.2	(7.0)	7.4	7.2	(7.0)	7.2	15.4	6.48		21.88	5
6 SONYA_AULIA NINGRUM (NTB)	067 PAIKU	(7.2)	(7.2)	(6.8)	(6.8)	(6.8)	(6.6)	(7.2)	(7.2)	7.2	7.2	7.2	7.2	7.2	7.2	15.12	6.48		21.6	7
7 BEATRIEX_HELENA PANGEMANAN_GK (JAKARTA)	047 KURURUNFA	(7.4)	(7.6)	(7.4)	(7.6)	(7.6)	7.6	7.4	(7.2)	7.4	7.4	(7.6)	7.6	7.4	(7.2)	15.54	6.78		22.32	1
8 I_GUSTI_AGUNG_KETUT ADINDA_BELIA (BANTEN)	015 GANKAKU	(7.4)	(7.2)	(7.2)	(7.2)	(7.4)	(7.2)	7.4	7.2	7.2	7.2	7.4	7.2	(7.0)	(7.0)	15.4	6.48		21.88	4

R3-G1 Tatami 1 14:30

Competitors	Kata	1T	1A	2T	2A	3T	3A	4T	4A	5T	5A	6T	6A	7T	7A	TEC	ATH	Extra	Total Rank	
1 AGHNNIA ZAMZAMI (INKANAS)	065 OYADOMARI NO PASSAI	7.8	7.6	(7.6)	7.6	7.8	(7.4)	7.8	7.6	(8.0)	(7.8)	(7.2)	(7.0)	(8.0)	(8.0)	16.38	6.84		23.22	2
2 INDAKA MAULAICA (BALI)	021 GOJUSHIHO SHO	(7.4)	(7.2)	7.6	7.4	(7.8)	7.6	(7.4)	(7.2)	(8.0)	(8.0)	7.4	7.6	7.6	(7.8)	15.82	6.78		22.6	4
3 NABILA_PUTRI RAMADHANI (INKAI)	021 GOJUSHIHO SHO	(7.4)	(7.4)	7.8	7.6	(8.0)	(8.0)	(7.6)	7.6	(8.0)	(7.8)	7.6	(7.4)	7.6	7.6	16.1	6.84		22.94	3
4 LALA DIAH_PITALOKA_IN (JABAR)	009 CHIBANA NO KUSHANKU	(7.8)	(7.8)	8.0	(7.8)	(8.2)	7.8	(7.8)	7.8	8.0	(8.0)	7.8	7.8	(8.2)	(8.0)	16.66	7.02		23.68	1

R3-G2 Tatami 2 14:30

Competitors	Kata	1T	1A	2T	2A	3T	3A	4T	4A	5T	5A	6T	6A	7T	7A	TEC	ATH	Extra	Total Rank	
1 BEATRIEX_HELENA PANGEMANAN_GK (JAKARTA)	092 SUPARINPEI	(7.6)	(7.8)	7.6	7.6	(7.4)	(7.4)	(7.8)	(7.8)	(7.4)	7.6	7.4	(7.2)	7.4	7.4	15.68	6.78		22.46	2
2 I_GUSTI_AGUNG_KETUT ADINDA_BELIA (BANTEN)	078 SANSAL	(7.4)	(7.4)	(7.4)	(7.4)	7.4	(7.6)	7.4	7.4	(7.6)	7.4	7.4	(7.0)	(7.2)	7.4	15.54	6.66		22.2	3
3 REVANIDA_SUKMA WIDI (BKC)	099 UNSU	(7.2)	(7.2)	7.4	7.2	7.4	7.2	(7.2)	(7.4)	(7.6)	(7.6)	7.4	(7.0)	(7.6)	7.4	15.54	6.54		22.08	4
4 INDAH FEBRIYANI_GK (LAMPUNG)	068 PAPUREN	(7.4)	(7.6)	7.4	7.6	7.4	7.6	(7.6)	7.6	(7.6)	(7.8)	7.6	(7.4)	(7.2)	(7.2)	15.68	6.84		22.52	1

R4 Bronze Medal Match 1 Tatami 1 14:45

Competitors	Kata	1T	1A	2T	2A	3T	3A	4T	4A	5T	5A	6T	6A	7T	7A	TEC	ATH	Extra	Total Rank	
1 AGHNNIA ZAMZAMI (INKANAS)	092 SUPARINPEI	(7.4)	(7.4)	(8.0)	(8.0)	(7.4)	(7.4)	(8.2)	(7.8)	7.6	7.6	8.0	7.8	7.6	7.4	16.24	6.84		23.08	1
2 I_GUSTI_AGUNG_KETUT ADINDA_BELIA (BANTEN)	099 UNSU	(7.2)	(7.4)	(7.8)	(7.6)	(7.0)	(7.2)	(8.0)	7.6	7.8	7.6	7.8	(7.8)	7.4	7.4	16.1	6.78		22.88	2

R4 Bronze Medal Match 2 Tatami 2 14:45

Competitors	Kata	1T	1A	2T	2A	3T	3A	4T	4A	5T	5A	6T	6A	7T	7A	TEC	ATH	Extra	Total Rank	
1 NABILA_PUTRI RAMADHANI (INKAI)	099 UNSU	(7.2)	(7.2)	7.4	(7.6)	(6.8)	(6.8)	(7.6)	7.4	7.4	7.4	7.4	7.2	(7.6)	(7.6)	15.54	6.6		22.14	2
2 BEATRIEX_HELENA PANGEMANAN_GK (JAKARTA)	068 PAPUREN	(7.6)	(7.4)	(7.6)	(7.6)	(7.4)	(7.6)	7.6	(7.6)	7.6	7.6	7.6	7.6	(7.8)	7.6	15.96	6.84		22.8	1

R4 Gold Medal Match Tatami 1 14:55

Competitors	Kata	1T	1A	2T	2A	3T	3A	4T	4A	5T	5A	6T	6A	7T	7A	TEC	ATH	Extra	Total Rank	
1 LALA DIAH_PITALOKA_IN (JABAR)	008 CHATANYARA KUSHANKU	(8.4)	(8.0)	(7.4)	(7.6)	(8.2)	(8.0)	7.8	8.0	7.8	8.0	7.8	(7.6)	(7.6)	7.8	16.38	7.14		23.52	1
2 INDAH FEBRIYANI_GK (LAMPUNG)	064 OHAN DAI	(8.2)	(7.8)	(7.4)	(7.2)	(7.8)	7.6	7.6	(7.8)	7.6	7.8	7.6	7.4	(7.4)	(7.2)	15.96	6.84		22.8	2

Results

1	LALA DIAH PITALOKA IN	JAWA BARAT		INDONESIA
2	INDAH FEBRIYANI GK	LAMPUNG		INDONESIA
3	AGHNNIA ZAMZAMI	INKANAS		INDONESIA
3	BEATRIEX HELENA PANGEMANAN GK	DKI JAKARTA		INDONESIA
5	I GUSTI AGUNG KETUT ADINDA BELIA	BANTEN		INDONESIA
5	NABILA PUTRI RAMADHANI	INKAI		INDONESIA
7	INDAKA MAULAICA	BALI		INDONESIA
7	REVANIDA SUKMA WIDI	BKC		INDONESIA

**KEJURNAS KARATE CADET, JUNIOR
& U21 TAHUN 2021 - 2021-11-05
KADET KATA PERORANGAN PUTRA**

8	M_AKIO ZAIKO_IS (JAKARTA)	064 OHAN DAI	(7.4)	(7.2)	(7.4)	7.4	7.4	7.4	(7.6)	(7.6)	7.4	(7.6)	(7.6)	7.4	7.4	(7.2)	15.54	6.66	22.2	1
---	---------------------------	--------------	-------	-------	-------	-----	-----	-----	-------	-------	-----	-------	-------	-----	-----	-------	-------	------	------	---

R3-G1 Tatami 1 10:30

Competitors	Kata	1T	1A	2T	2A	3T	3A	4T	4A	5T	5A	6T	6A	7T	7A	TEC	ATH	Extra	Total Rank	
1	ABYAN_AL FADHIL_ (INKAI)	021 GOJUSHIHO SHO	(8.0)	7.8	(8.0)	7.8	7.8	(7.6)	7.8	(8.0)	7.8	(8.0)	(7.4)	(7.6)	(7.6)	7.6	16.38	6.96	23.34	2
2	DIMAS PUTRA_IN (JABAR)	099 UNSU	(7.8)	(7.8)	(7.8)	(7.8)	(7.6)	(7.4)	7.6	7.8	7.6	7.6	7.8	7.4	(7.4)	(7.2)	16.1	6.84	22.94	3
3	AYMAN_RAHMAT AL_BADI (INKANAS)	009 CHIBANA NO KUSHANKU	(8.0)	(8.0)	(7.8)	(7.6)	(7.8)	7.8	(8.0)	7.8	8.0	(8.0)	7.8	7.8	(7.6)		16.52	7.02	23.54	1
4	DAFFA RADITYA_WIDIARTA (NTB)	078 SANSAL	(7.8)	(7.6)	7.4	(7.2)	7.4	(7.2)	(7.8)	7.4	(7.2)	7.4	(7.2)	(7.6)	7.2	7.4	15.4	6.66	22.06	4

R4 Bronze Medal Match 1 Tatami 1 10:45

Competitors	Kata	1T	1A	2T	2A	3T	3A	4T	4A	5T	5A	6T	6A	7T	7A	TEC	ATH	Extra	Total Rank	
1	MUHAMMAD_ABIMEYZHAR NUGRAHA (GOJUKAI)	064 OHAN DAI	(8.0)	(8.0)	(7.4)	(7.4)	7.8	7.6	7.8	7.6	(7.2)	(7.4)	7.6	7.6	(8.4)	(8.4)	16.24	6.84	23.08	2
2	ABYAN_AL FADHIL_ (INKAI)	015 GANKAKU	(7.8)	(7.8)	(8.0)	8.0	8.0	8.0	8.0	7.8	7.8	(8.2)	(7.4)	(7.6)	(8.6)	(8.6)	16.66	7.14	23.8	1

R4 Bronze Medal Match 2 Tatami 2 10:45

Competitors	Kata	1T	1A	2T	2A	3T	3A	4T	4A	5T	5A	6T	6A	7T	7A	TEC	ATH	Extra	Total Rank	
1	ADZI AHMAD_DZIKRILLAH (GABDIKA)	001 ANAN	(7.6)	(7.4)	(7.4)	(7.6)	(7.4)	7.4	7.4	7.6	(7.6)	7.4	7.6	(7.8)	7.6	(7.2)	15.82	6.72	22.54	1
2	DIMAS PUTRA_IN (JABAR)	020 GOJUSHIHO DAI	(7.4)	7.4	(7.2)	7.2	7.4	(7.6)	(7.2)	(7.0)	7.2	(7.0)	7.4	(7.6)	(7.8)	7.4	15.4	6.6	22.0	2









R4 Gold Medal Match Tatami 1 10:55

Competitors	Kata	1T	1A	2T	2A	3T	3A	4T	4A	5T	5A	6T	6A	7T	7A	TEC	ATH	Extra	Total Rank	
1	M_AKIO ZAIKO_IS (JAKARTA)	008 CHATANYARA KUSHANKU	(8.2)	(8.0)	8.0	7.8	(8.4)	(8.6)	8.0	7.8	(7.8)	(7.6)	(7.8)	(7.6)	7.8	7.8	16.66	7.02	23.68	1
2	AYMAN_RAHMAT AL_BADI (INKANAS)	008 CHATANYARA KUSHANKU	7.8	7.8	(8.2)	(8.0)	(7.4)	(7.2)	7.8	(7.6)	(7.6)	7.6	(8.0)	(8.0)	7.6	7.8	16.24	6.96	23.2	2

R3-G2 Tatami 2 10:30

Competitors	Kata	1T	1A	2T	2A	3T	3A	4T	4A	5T	5A	6T	6A	7T	7A	TEC	ATH	Extra	Total Rank	
1	ADZI AHMAD_DZIKRILLAH (GABDIKA)	008 CHATANYARA KUSHANKU	(7.8)	(7.6)	(7.2)	(7.0)	(7.4)	(7.6)	(7.6)	7.6	7.4	(7.4)	7.4	7.4	7.6	15.54	6.78	22.32	2	
2	M_AKIO ZAIKO_IS (JAKARTA)		(7.4)	(7.4)	(7.6)	(7.4)	(7.6)	7.4	(7.4)	7.4	7.6	(7.6)	7.6	7.4	7.6	(7.8)	15.96	6.66	22.62	1
3	FURQON_ADRIANO SANGGO (LEMKARI)	099 UNSU	7.2	7.2	(7.0)	(6.8)	(7.4)	(7.4)	7.2	(7.4)	7.2	(7.0)	(7.4)	7.2	(7.0)	7.0	15.12	6.42	21.54	4
4	MUHAMMAD_ABIMEYZHAR NUGRAHA (GOJUKAI)	009 CHIBANA NO KUSHANKU	(7.2)	7.4	(7.4)	(7.0)	(7.6)	(7.6)	7.4	(7.6)	(7.0)	(7.2)	7.4	7.6	7.4	7.4	15.54	6.72	22.26	3

Results

1	M AKIO ZAIKO IS	DKI JAKARTA		INDONESIA
2	AYMAN RAHMAT AL BADI	INKANAS		INDONESIA
3	ABYAN AL FADHIL	INKAI		INDONESIA
3	ADZI AHMAD DZIKRILLAH	GABDIKA SHITORYUKAI		INDONESIA
5	MUHAMMAD ABIMEYZHAR NUGRAHA	GOJUKAI		INDONESIA
5	DIMAS PUTRA IN	JAWA BARAT		INDONESIA
7	DAFFA RADITYA WIDIARTA	NUSA TENGGARA BARAT		INDONESIA
7	FURQON ADRIANO SANGGO	LEMKARI		INDONESIA

**KEJURNAS KARATE CADET, JUNIOR
& U21 TAHUN 2021 - 2021-11-05
KADET KATA PERORANGAN PUTRI**

R1 G1/4 (8) Tatami 3 09:00

Competitors	Kata	1T	1A	2T	2A	3T	3A	4T	4A	5T	5A	6T	6A	7T	7A	TEC	ATH	Extra	Total	Rank
1 DEA_DESTIA RENATA_SITORUS (KALBAR)	064 OHAN DAI	(6.6)	(6.6)	6.8	(6.8)	(6.6)	6.8	(7.0)	6.8	(7.4)	(7.2)	6.8	6.8	6.8	(6.6)	14.28	6.12		20.4	7
2 SHABRINA MARDHATILLAH (GOKASI)	068 PAPUREN	(6.8)	(6.8)	(7.0)	6.8	(7.0)	(7.0)	(7.2)	7.0	7.0	6.8	7.0	(7.2)	7.0	(6.6)	14.7	6.18		20.88	4
3 SITI_YASMIN_NUR_LATIFAH_IN (JABAR)	099 UNSU	(7.4)	(7.4)	(6.8)	(6.6)	(7.4)	(7.4)	7.0	7.0	(6.6)	(6.2)	7.4	7.4	7.0	6.8	14.98	6.36		21.34	3
4 MEISYA_PUTRI NURAINI_IS (JATIM)	001 ANAN	(7.0)	(7.0)	7.4	(7.4)	7.4	7.2	(7.2)	(7.4)	(7.6)	7.2	(7.6)	7.4	7.4	(7.0)	15.54	6.54		22.08	1
5 SYIFA_AMALIA AKHMAD (INKANAS)	002 ANAN DAI	(7.2)	(7.4)	(7.6)	(7.6)	(7.0)	7.2	7.0	(7.0)	(6.8)	(6.6)	7.2	7.4	7.2	7.0	14.98	6.48		21.46	2
6 NATASYA AQIFA_SATRIYA (SUMUT)	008 CHATANYARA KUSHANKU	(7.6)	(7.2)	(6.6)	(6.8)	6.8	7.0	6.8	(7.2)	(6.2)	(6.0)	(7.0)	7.2	6.6	6.8	14.14	6.3		20.44	6
7 ALMIRA_VALDA MAISE_WIJAYA (GOJUKAI)	068 PAPUREN	(6.6)	(6.4)	6.8	(7.0)	(7.2)	(7.4)	(7.2)	(6.8)	7.0	6.8	(6.6)	6.8	7.0	7.0	14.56	6.18		20.74	5
8 AMELYA_RAIA AZAHRA_IN (SULTENG)																				

R1 G2/4 (8) Tatami 3 09:30

Competitors	Kata	1T	1A	2T	2A	3T	3A	4T	4A	5T	5A	6T	6A	7T	7A	TEC	ATH	Extra	Total	Rank
1 ANDINI_ALIFIAH NURCAHYA (BUDOKAI)	068 PAPUREN	(7.4)	7.2	(7.4)	7.2	(7.0)	7.2	(7.0)	(6.8)	7.4	(7.4)	7.0	(6.6)	7.0	(7.4)	14.98	6.48		21.46	5
2 LAYLI_WILMA GHANIA_PP (SHOKAIDO)	021 GOJUSHIHO SHO	(6.6)	(6.6)	(7.0)	6.8	(7.2)	(7.4)	(6.8)	(7.0)	6.8	6.8	6.8	(6.4)	7.0	6.8	14.42	6.12		20.54	7
3 NURUL_SANDIKA MAUDI-IN (KALTIM)	099 UNSU	(6.8)	(6.8)	(7.6)	(7.4)	(8.2)	(8.2)	(6.6)	6.8	7.6	7.4	6.8	(6.6)	7.0	6.8	14.98	6.3		21.28	6
4 CLARESTA_ARALEA SALIM (BALI)	021 GOJUSHIHO SHO	(7.2)	(7.2)	(7.2)	(7.4)	(8.6)	(8.6)	7.2	7.2	7.2	7.2	7.2	(7.0)	(7.4)	7.2	15.12	6.48		21.6	4
5 NADLIMA LAYLA_IN (JAKARTA)	041 KANKU SHO	7.4	7.2	(7.6)	(7.8)	(8.4)	(8.6)	7.4	7.4	7.2	7.4	(6.8)	(6.6)	(7.0)	(7.0)	15.4	6.6		22.0	2
6 SALSABILA_RIHADATUL_AISY AMRULLAH (KEISHINKAN)	009 CHIBANA NO KUSHANKU	(7.6)	7.4	(7.8)	(7.8)	7.6	(7.6)	(7.0)	7.4	7.4	7.2	(6.6)	(6.4)	7.0	(6.8)	15.4	6.6		22.0	3
7 RENATA_GLORY MADAO (INKADO)	002 ANAN DAI	7.4	(7.6)	(7.6)	7.6	(8.2)	(8.2)	(7.0)	7.4	(7.0)	(7.0)	7.4	7.2	7.2	(7.0)	15.4	6.66		22.06	1
8 ANDHIRA_LARAS DONSKA (BENGKULU)																				

R1 G3/4 (8) Tatami 4 09:00

Competitors	Kata	1T	1A	2T	2A	3T	3A	4T	4A	5T	5A	6T	6A	7T	7A	TEC	ATH	Extra	Total	Rank
1 KEINDAHAN_ELANEL YAHYA_BD (JATENG)	068 PAPUREN	7.2	(7.2)	(7.8)	(7.6)	(6.4)	(6.4)	7.2	(6.8)	(7.4)	7.0	7.2	7.0	(7.0)	6.8	15.12	6.24		21.36	5
2 ZHRATUS SYIFA (SUMBAR)	015 GANKAKU	7.0	(7.2)	(7.4)	(7.2)	(6.8)	6.8	7.0	(6.6)	(6.8)	(6.6)	7.0	6.8	(7.4)	6.8	14.7	6.12		20.82	7
3 ANDHARA_LOIS YOWEIS_PUTRO_IN (LAMPUNG)	068 PAPUREN	(7.2)	7.4	(7.6)	(7.6)	(7.6)	(7.6)	7.2	(6.8)	7.2	(7.0)	7.4	7.4	(7.0)	7.0	15.26	6.54		21.8	3
4 NAYLA_MONIKA AUGUSTINE_(GOJU ASS)	002 ANAN DAI	7.0	(7.4)	(7.2)	(7.4)	(7.2)	(7.2)	7.0	7.2	(6.6)	(6.8)	(6.8)	7.2	6.8	7.2	14.56	6.48		21.04	6
5 BAIQ_WINDA CAHAYA_INSANI_IS (NTB)	015 GANKAKU	6.8	6.8	(7.2)	(7.2)	(6.6)	(6.6)	7.2	6.6	(6.4)	(6.4)	(7.4)	(7.0)	6.6	6.8	14.42	6.06		20.48	8
6 SALMA AULIA_(INKAI)	041 KANKU SHO	(7.4)	7.4	(7.4)	(7.0)	(7.0)	(7.0)	7.4	7.2	(7.0)	7.0	7.4	(7.6)	7.2	(7.6)	15.4	6.48		21.88	2
7 SYAFIRA RAMDHANI (GABDIKA)	068 PAPUREN	(7.0)	(7.0)	(7.6)	(7.6)	7.4	(7.4)	(7.0)	(6.8)	(7.6)	7.2	7.0	7.2	7.2	7.0	15.12	6.42		21.54	4
8 SHELOMITHA_LIE HOSANG (SULUT)	068 PAPUREN	(7.4)	7.2	7.4	(7.0)	(7.8)	(7.8)	7.4	7.0	(6.8)	(6.6)	(7.2)	(7.4)	7.4	7.2	15.54	6.42		21.96	1

R1 G4/4 (8) Tatami 4 09:30

Competitors	Kata	1T	1A	2T	2A	3T	3A	4T	4A	5T	5A	6T	6A	7T	7A	TEC	ATH	Extra	Total	Rank
1 NAVA_CANTIKA MAJID (PAPUA)	001 ANAN	6.6	(6.8)	6.6	(6.8)	(6.4)	(6.2)	(6.4)	6.6	(6.8)	6.8	(7.0)	6.8	6.6	(6.4)	13.86	6.06		19.92	7
2 VINA ZULMANIA (LEMKARI)	021 GOJUSHIHO SHO	(6.6)	(6.6)	(6.4)	(6.6)	(6.6)	6.4	6.4	(6.2)	6.6	6.4	6.6	6.4	(6.2)	(6.0)	13.72	5.76		19.48	8
3 CHINTYA OLIFIAMDARI_PW (PORBIKAWA)	021 GOJUSHIHO SHO	(7.2)	(7.0)	(6.8)	(7.0)	(6.4)	(6.4)	(6.6)	6.8	6.8	6.8	6.8	6.8	(6.6)	(6.6)	14.28	6.12		20.4	5
4 NAURAH RAUDHATUL_JANNAH_WK (SUMSEL)	078 SANSAN	7.0	7.0	(6.8)	(6.8)	(6.8)	(6.6)	7.0	7.0	7.2	(7.2)	(7.4)	(7.2)	(7.4)	7.2	14.84	6.36		21.2	4
5 TALITHA_SALWA AFANDI (BABEL)	041 KANKU SHO	(6.6)	(6.6)	(7.0)	(7.2)	6.6	(6.6)	(6.4)	6.8	(7.0)	(7.0)	7.0	7.0	6.6	6.6	14.14	6.12		20.26	6
6 KAYLA_TABRANI AMIRUDDIN_IS (SULSEL)	068 PAPUREN	(7.0)	(7.2)	(7.2)	(7.2)	7.2	(7.0)	(7.4)	7.2	(7.4)	7.2	7.4	(7.4)	7.2	7.2	15.26	6.48		21.74	1
7 SEPTI_DWI ANGGRAENI_(BKC)	099 UNSU	(6.8)	(6.8)	(7.2)	(7.4)	(7.0)	(6.8)	(7.4)	(7.4)	7.2	7.2	7.2	7.2	7.0	6.8	14.98	6.36		21.34	3
8 NAYLA_SAUSAN SATIVA_W_SI (SHINDOKA)	002 ANAN DAI	(7.0)	(6.8)	(7.4)	(7.2)	(7.0)	(7.0)	(7.6)	(7.6)	7.2	7.0	7.4	7.2	7.2	7.0	15.26	6.36		21.62	2

R2-G1 Tatami 3 10:00

Competitors	Kata	1T	1A	2T	2A	3T	3A	4T	4A	5T	5A	6T	6A	7T	7A	TEC	ATH	Extra	Total	Rank
1 CLARESTA_ARALEA SALIM (BALI)	015 GANKAKU	(7.6)	(7.4)	(7.6)	(7.4)	(6.6)	(6.6)	(7.2)	(7.0)	7.4	7.4	7.2	7.4	7.4	7.2	15.4	6.6		22.0	6
2 NADLIMA LAYLA_IN (JAKARTA)	002 ANAN DAI	7.4	(7.2)	(7.2)	(7.2)	(7.6)	(7.4)	(7.2)	7.4	7.2	7.2	(7.8)	(7.8)	7.6	7.4	15.54	6.6		22.14	3
3 SITI_YASMIN_NUR_LATIFAH_IN (JABAR)	020 GOJUSHIHO DAI	(7.6)	(7.2)	7.6	(7.6)	(7.0)	(7.0)	(7.4)	7.4	(7.8)	(7.6)	7.6	7.6	7.4	7.4	15.82	6.72		22.54	2
4 SYIFA_AMALIA AKHMAD (INKANAS)	068 PAPUREN	7.6	(7.4)	(7.8)	(7.6)	(7.4)	(7.4)	(7.4)	7.6	7.6	7.6	(8.0)	(8.0)	7.6	7.6	15.96	6.84		22.8	1
5 RENATA_GLORY MADAO (INKADO)	068 PAPUREN	7.4	(7.2)	(7.0)	(7.2)	7.4	7.2	(6.8)	7.2	7.4	(7.6)	(7.8)	(8.0)	(7.6)	7.4	15.54	6.54		22.08	4
6 SHABRINA MARDHATILLAH (GOKASI)	092 SUPARINPEI	(7.2)	(7.2)	(7.2)	(7.0)	7.2	(7.0)	(7.4)	7.2	7.2	7.2	(7.4)	7.2	7.4	(7.6)	15.26	6.48		21.74	7
7 SALSABILA_RIHADATUL_AISY AMRULLAH (KEISHINKAN)	078 SANSAN	(7.2)	(7.0)	(6.8)	(7.2)	7.2	(7.4)	(6.8)	(6.8)	7.0	7.0	(7.4)	7.2	7.2	7.2	14.98	6.42		21.4	8
8 MEISYA_PUTRI NURAINI_IS (JATIM)	002 ANAN DAI	(7.6)	(7.4)	(7.4)	(7.4)	7.4	(7.0)	(7.0)	(7.0)	7.4	7.2	(7.8)	7.4	7.4	7.0	15.54	6.48		22.02	5

R2-G2 Tatami 4 10:00

**KEJURNAS KARATE CADET, JUNIOR
& U21 TAHUN 2021 - 2021-11-05
KADET KATA PERORANGAN PUTRI**

Competitors	Kata	1T	1A	2T	2A	3T	3A	4T	4A	5T	5A	6T	6A	7T	7A	TEC	ATH	Extra	Total Rank
1 SALMA AULIA_ (INKAI)	041 KANKU SHO	(7.0)	(7.0)	(7.2)	7.2	7.2	7.2	7.0	(7.4)	(7.4)	7.2	(6.8)	(7.4)	(7.6)	15.12	6.42			21.544
2 SEPTI DWI ANGGRAENI_ (BKC)	068 PAPUREN	(7.2)	7.0	(6.8)	(6.8)	(7.0)	7.2	7.0	7.2	(7.2)	(7.4)	7.0	(6.6)	7.2	(7.4)	14.84	6.42		21.267
3 ANDHARA LOIS YOWEIS_PUTRO_IN (LAMPUNG)	015 GANKAKU	7.4	(7.2)	(7.6)	(7.6)	7.4	7.4	(7.2)	7.4	(7.6)	(7.6)	(7.0)	(7.2)	7.4	7.6	15.54	6.72		22.261
4 NAURAH RAUDHATUL_JANNAH_WK (SUMSEL)																			
5 SYAFIRA RAMDHANI (GABDIKA)	008 CHATANYARA KUSHANKU	(7.2)	7.2	(7.0)	7.0	(7.0)	(6.8)	(7.2)	7.2	7.2	(7.4)	7.2	(6.8)	7.2	(7.4)	15.12	6.42		21.545
6 SHELOMITHA_LIE HOSANG (SULUT)	015 GANKAKU	(7.4)	7.2	7.4	(7.4)	(7.2)	(7.0)	(7.2)	(6.8)	(7.6)	(7.4)	7.4	7.2	7.4	7.4	15.54	6.54		22.083
7 NAYLA SAUSAN SATIVA_W_SI (SHINDOKA)	068 PAPUREN	7.4	(7.4)	(7.8)	(7.8)	(7.0)	(7.2)	7.4	7.2	(7.8)	7.4	(7.2)	(7.0)	7.4	7.2	15.54	6.54		22.082
8 KAYLA_TABRANI AMIRUDDIN_IS (SULSEL)	009 CHIBANA NO KUSHANKU	7.0	7.0	(6.6)	(6.6)	(6.8)	(6.8)	7.2	(7.2)	(7.4)	7.0	(7.4)	7.0	7.4	(7.2)	15.12	6.3		21.426

R3-G1 Tatami 3 10:30

Competitors	Kata	1T	1A	2T	2A	3T	3A	4T	4A	5T	5A	6T	6A	7T	7A	TEC	ATH	Extra	Total Rank
1 SITI YASMIN_NUR_LATIFAH_IN (JABAR)	002 ANAN DAI	(7.4)	(7.6)	(7.6)	(7.4)	(7.2)	7.4	7.4	(7.2)	(7.2)	7.4	7.2	(7.2)	7.4	7.2	15.4	6.6		22.0 3
2 SYIFA_AMALIA AKHMAD (INKANAS)	009 CHIBANA NO KUSHANKU	(7.6)	(7.4)	(7.4)	7.4	7.4	(7.6)	(7.0)	(6.8)	(7.6)	(7.6)	7.4	7.4	7.6	7.4	15.68	6.66		22.342
3 RENATA_GLODY MADA0 (INKADO)	008 CHATANYARA KUSHANKU	7.2	(7.4)	(6.6)	(6.6)	(6.8)	(7.2)	6.8	(6.4)	(7.4)	7.2	7.4	7.2	(7.6)	7.2	14.98	6.48		21.464
4 NADLIMA LAYLA_IN (JAKARTA)	099 UNSU	(7.0)	(7.4)	(7.2)	(7.2)	7.4	(7.6)	(7.6)	7.4	(7.8)	(7.8)	7.4	7.6	7.6	7.4	15.68	6.72		22.4 1

R3-G2 Tatami 4 10:30

Competitors	Kata	1T	1A	2T	2A	3T	3A	4T	4A	5T	5A	6T	6A	7T	7A	TEC	ATH	Extra	Total Rank
1 NAYLA SAUSAN SATIVA_W_SI (SHINDOKA)	009 CHIBANA NO KUSHANKU	(7.6)	(7.4)	(7.4)	7.2	7.4	7.2	(6.8)	(7.4)	(7.2)	(7.0)	7.2	(7.0)	7.4	7.0	15.4	6.42		21.823
2 ANDHARA LOIS YOWEIS_PUTRO_IN (LAMPUNG)	064 OHAN DAI	(7.6)	(7.6)	(7.4)	(7.6)	(7.6)	(7.4)	(7.2)	7.6	7.4	(7.4)	7.4	7.4	7.6	7.6	15.68	6.78		22.461
3 SALMA AULIA_ (INKAI)	020 GOJUSHIHO DAI	7.2	7.2	(7.4)	(7.4)	(7.0)	(7.0)	(7.8)	(7.4)	7.4	7.2	(7.0)	(7.0)	7.4	7.2	15.4	6.48		21.882
4 SHELOMITHA_LIE HOSANG (SULUT)	008 CHATANYARA KUSHANKU	7.2	(7.4)	7.2	7.4	(7.6)	(7.6)	(7.0)	(7.2)	(7.6)	7.4	(6.8)	(6.8)	7.0	7.4	14.98	6.66		21.644

R4 Bronze Medal Match 1 Tatami 3 10:45

Competitors	Kata	1T	1A	2T	2A	3T	3A	4T	4A	5T	5A	6T	6A	7T	7A	TEC	ATH	Extra	Total Rank
1 SYIFA_AMALIA AKHMAD (INKANAS)	099 UNSU	(7.8)	(7.8)	(7.8)	(7.8)	(7.4)	(7.4)	(7.4)	7.6	7.8	7.6	7.4	(7.4)	7.4	7.4	15.82	6.78		22.6 1
2 NAYLA SAUSAN SATIVA_W_SI (SHINDOKA)	048 KUSANKU	(7.6)	(7.6)	(7.6)	(7.4)	(7.2)	(7.2)	(7.2)	(7.2)	7.4	7.2	7.2	7.2	7.2	7.2	15.26	6.48		21.742

R4 Bronze Medal Match 2 Tatami 4 10:45

Competitors	Kata	1T	1A	2T	2A	3T	3A	4T	4A	5T	5A	6T	6A	7T	7A	TEC	ATH	Extra	Total Rank
1 SITI YASMIN_NUR_LATIFAH_IN (JABAR)	068 PAPUREN	(7.0)	(7.0)	(7.4)	(7.4)	(8.2)	(7.8)	(7.8)	(7.6)	7.6	7.6	7.4	7.6	7.6	7.4	15.82	6.78		22.6 1
2 SALMA AULIA_ (INKAI)	099 UNSU	(7.4)	7.4	(7.2)	(7.0)	(8.0)	(7.6)	(7.4)	(7.2)	7.4	7.4	7.4	(7.6)	7.4	7.2	15.54	6.6		22.142

R4 Gold Medal Match Tatami 3 10:55

Competitors	Kata	1T	1A	2T	2A	3T	3A	4T	4A	5T	5A	6T	6A	7T	7A	TEC	ATH	Extra	Total Rank
1 NADLIMA LAYLA_IN (JAKARTA)	009 CHIBANA NO KUSHANKU	(8.0)	7.6	(7.4)	(7.4)	(7.4)	7.6	(8.0)	(8.0)	8.0	(8.0)	7.4	7.6	7.4	(7.4)	15.96	6.84		22.8 1
2 ANDHARA LOIS YOWEIS_PUTRO_IN (LAMPUNG)	020 GOJUSHIHO DAI	7.6	7.4	(7.2)	(7.2)	(7.2)	(7.2)	(7.8)	(7.8)	(8.2)	(8.2)	7.2	7.4	7.2	7.4	15.4	6.66		22.062

Results

1	NADLIMA LAYLA IN	DKI JAKARTA		INDONESIA
2	ANDHARA LOIS YOWEIS PUTRO IN	LAMPUNG		INDONESIA
3	SYIFA AMALIA AKHMAD	INKANAS		INDONESIA
3	SITI YASMIN NUR LATIFAH IN	JAWA BARAT		INDONESIA
5	NAYLA SAUSAN SATIVA W SI	SHINDOKA		INDONESIA
5	SALMA AULIA	INKAI		INDONESIA
7	RENATA GLORY MADA0	INKADO		INDONESIA
7	SHELOMITHA LIE HOSANG	SULAWESI UTARA		INDONESIA

**KEJURNAS KARATE CADET, JUNIOR
& U21 TAHUN 2021 - 2021-11-05
U21 KATA PERORANGAN PUTRA**

5	UNGGUL_PRAYOGA_DWI SAPUTRA_ID (KALTIM)	002 ANAN DAI	(7.4)	(7.4)	7.4	7.2	7.4	7.2	(7.2)	7.2	7.2	(7.0)	(7.0)	(6.8)	(7.6)	(7.8)	15.4	6.48	21.884	
6	RAFKY_PRASETYA HARIONO (SHOTOKAI)	099 UNSU	(6.6)	(6.6)	7.2	(7.2)	(7.0)	7.2	(7.4)	(7.4)	7.2	(7.4)	7.4	7.2	(7.6)	7.4	15.26	6.54	21.8	5
7	DIMAS HERI_GK (JATENG)	086 SEISAN	(7.0)	(7.0)	(7.0)	(6.8)	(7.4)	7.2	7.2	7.0	(7.4)	(7.4)	7.2	7.2	7.4	(7.4)	15.26	6.42	21.687	
8	JIBRIL BRILLIANT_SMITH_ID (INKADO)	099 UNSU	(7.4)	7.4	(7.6)	(7.6)	(7.4)	(7.2)	7.4	(7.2)	7.4	(7.6)	7.4	7.6	(7.6)	7.6	15.54	6.78	22.321	

R3-G1 Tatami 1 16:30

Competitors	Kata	1 T	1 A	2 T	2 A	3 T	3 A	4 T	4 A	5 T	5 A	6 T	6 A	7 T	7 A	TEC	ATH	Extra	Total Rank
1 JULIUS EMMANUEL SIHITE (INKAI)	041 KANKU SHO	(7.6)	(7.6)	(7.4)	7.6	(7.4)	(7.2)	7.6	(7.4)	7.6	7.6	(7.8)	(7.8)	7.4	7.4	15.82	6.78	22.6	2
2 OCNIEL JUANDI_SIMARMATA (LAMPUNG)	068 PAPUREN	(7.6)	(7.8)	(7.6)	(7.8)	7.6	7.6	(7.8)	(7.4)	7.6	(7.4)	(7.4)	7.4	7.6	7.8	15.96	6.84	22.8	1
3 YUDA FADILA_PRATAMA_BC (JABAR)	064 OHAN DAI	(7.8)	(7.6)	(7.4)	(7.4)	7.6	(7.4)	(7.4)	7.4	7.4	7.4	7.6	(7.6)	(7.8)	7.6	15.82	6.72	22.54	3
4 MUHAMMAD_RAFLI SAPUTRA (INKANAS)	099 UNSU	(7.6)	(7.4)	(7.6)	(7.4)	7.4	(7.2)	(7.2)	7.4	7.4	(7.2)	(7.2)	7.2	7.4	7.2	15.54	6.54	22.08	4

R3-G2 Tatami 2 16:30

Competitors	Kata	1 T	1 A	2 T	2 A	3 T	3 A	4 T	4 A	5 T	5 A	6 T	6 A	7 T	7 A	TEC	ATH	Extra	Total Rank
1 JIBRIL BRILLIANT_SMITH_ID (INKADO)	015 GANKAKU	(7.2)	(7.0)	(7.6)	(7.4)	(7.4)	(7.6)	7.4	7.4	7.4	7.4	(7.6)	(7.6)	7.4	7.4	15.54	6.66	22.2	1
2 FERRY LAODRY_BC (SULSEL)	041 KANKU SHO	(7.4)	(7.2)	(7.0)	(7.2)	(7.0)	7.2	7.2	7.2	7.2	(7.4)	7.0	(7.0)	(7.4)	7.2	14.98	6.48	21.46	4
3 UNGGUL_PRAYOGA_DWI SAPUTRA_ID (KALTIM)	092 SUPARINPEI	(7.2)	(7.0)	(7.0)	(7.4)	(7.4)	(7.4)	(7.2)	7.4	7.2	(7.2)	7.2	7.2	7.2	7.2	15.12	6.54	21.66	2
4 MUHAMMAD HAIQAL_PRIZI_IN (JAKARTA)	099 UNSU	(7.2)	(6.8)	(7.2)	7.2	7.2	7.2	7.2	7.2	7.2	(7.4)	(7.4)	(7.4)	(7.0)	(7.0)	15.12	6.48	21.6	3

R4 Bronze Medal Match 1 Tatami 1 16:45

Competitors	Kata	1 T	1 A	2 T	2 A	3 T	3 A	4 T	4 A	5 T	5 A	6 T	6 A	7 T	7 A	TEC	ATH	Extra	Total Rank
1 JULIUS EMMANUEL SIHITE (INKAI)	015 GANKAKU	(7.8)	(7.6)	(7.4)	(7.4)	7.4	(7.4)	7.4	(7.4)	(7.6)	7.4	7.6	7.4	(7.2)	7.4	15.68	6.66	22.34	1
2 MUHAMMAD HAIQAL_PRIZI_IN (JAKARTA)	064 OHAN DAI	(7.4)	(7.4)	(7.2)	(7.2)	7.4	(7.6)	(7.6)	7.4	(7.2)	7.2	7.4	(7.0)	7.2	7.2	15.4	6.54	21.94	2

R4 Bronze Medal Match 2 Tatami 2 16:45

Competitors	Kata	1 T	1 A	2 T	2 A	3 T	3 A	4 T	4 A	5 T	5 A	6 T	6 A	7 T	7 A	TEC	ATH	Extra	Total Rank
1 YUDA FADILA_PRATAMA_BC (JABAR)	092 SUPARINPEI	7.6	7.6	(7.4)	(7.4)	(7.8)	(7.8)	(7.8)	(7.8)	7.8	7.6	7.6	(7.4)	(7.4)	7.6	16.1	6.84	22.94	1
2 UNGGUL_PRAYOGA_DWI SAPUTRA_ID (KALTIM)	099 UNSU	(7.4)	(7.6)	7.4	(7.2)	7.4	(7.4)	7.4	7.4	(7.6)	7.4	(7.2)	(7.0)	(7.2)	7.4	15.54	6.66	22.2	2

R4 Gold Medal Match Tatami 2 16:55

Competitors	Kata	1 T	1 A	2 T	2 A	3 T	3 A	4 T	4 A	5 T	5 A	6 T	6 A	7 T	7 A	TEC	ATH	Extra	Total Rank
1 OCNIEL JUANDI_SIMARMATA (LAMPUNG)	064 OHAN DAI	(7.4)	7.6	(7.8)	(7.8)	(8.0)	(7.8)	(7.6)	(7.4)	7.6	7.6	7.6	7.8	7.6	(7.4)	15.96	6.9	22.86	2
2 JIBRIL BRILLIANT_SMITH_ID (INKADO)	091 SOCHIN	(7.8)	(7.8)	(7.6)	7.6	7.6	(7.4)	(7.8)	7.6	7.8	(7.8)	7.6	(7.4)	(7.4)	7.4	16.1	6.78	22.88	1

Results

1	JIBRIL BRILLIANT SMITH ID	INKADO		INDONESIA
2	OCNIEL JUANDI SIMARMATA	LAMPUNG		INDONESIA
3	JULIUS EMMANUEL SIHITE	INKAI		INDONESIA
3	YUDA FADILA PRATAMA BC	JAWA BARAT		INDONESIA
5	MUHAMMAD HAIQAL PRIZI IN	DKI JAKARTA		INDONESIA
5	UNGGUL PRAYOGA DWI SAPUTRA ID	KALIMANTAN TIMUR		INDONESIA
7	MUHAMMAD RAFLI SAPUTRA	INKANAS		INDONESIA
7	FERRY LAODRY BC	SULAWESI SELATAN		INDONESIA

**KEJURNAS KARATE CADET, JUNIOR
& U21 TAHUN 2021 - 2021-11-05
U21 KATA PERORANGAN PUTRI**

5	SEPTRIANI __ (GOJU ASS)	009 CHIBANA NO KUSHANKU	(7.2)	7.4	(7.2)	7.4	(7.6)	7.4	7.2	(7.0)	(8.0)	(8.0)	7.6	(7.6)	7.4	(7.2)	15.54	6.66		22.2	4
6	NUR RIZKA_FAUZIAH (INKANAS)	009 CHIBANA NO KUSHANKU	7.6	7.4	(7.2)	7.4	7.6	(7.6)	(7.8)	(7.8)	(7.2)	(7.2)	(7.8)	7.6	7.2	(7.2)	15.68	6.72		22.4	2
7	NURFADILLAH SOVIE-ASKI (KALTIM)	009 CHIBANA NO KUSHANKU	7.2	(7.4)	7.2	7.2	(7.4)	(7.4)	(7.4)	7.4	(6.8)	(6.8)	7.4	7.4	(7.0)	(7.0)	15.26	6.6		21.86	7
8	MARITZA EKA_RAHMADHANI (INKADO)	015 GANKAKU	7.4	(7.6)	7.4	(7.6)	7.4	7.6	(7.6)	(7.4)	(7.0)	(7.0)	(7.8)	7.4	(7.2)	7.4	15.54	6.72		22.26	3

R3-G1 Tatami 3 16:15

Competitors	Kata	1T	1A	2T	2A	3T	3A	4T	4A	5T	5A	6T	6A	7T	7A	TEC	ATH	Extra	Total	Rank	
1	SINTA_SOFIA MARDANI (SHOKAIDO)	078 SANSAI	7.2	(7.4)	7.2	(7.4)	(7.4)	(7.0)	(6.8)	(6.8)	7.2	7.0	(7.0)	7.0	(7.4)	7.2	15.12	6.36		21.48	4
2	SAMRANI_NUR AZIZAH IS (JAKARTA)	002 ANAN DAI	(7.6)	(7.6)	7.4	(7.2)	(7.6)	(7.4)	(7.2)	7.2	7.4	(7.0)	7.4	7.4	(7.2)	7.2	15.54	6.54		22.08	1
3	LAILA_NURUL HUMAIROH IN (JATENG)	099 UNSU	(7.6)	(7.4)	(7.0)	(7.0)	7.2	(7.0)	(7.6)	7.2	(6.8)	7.2	7.6	(7.4)	7.4	7.4	15.54	6.54		22.08	2
4	ANNISA_NUR HIDAYAT (GABDIKA)	068 PAPUREN	(7.4)	(7.4)	(7.6)	(7.6)	7.4	(7.2)	(7.2)	(7.2)	7.4	7.2	7.4	7.2	(7.2)	7.2	15.54	6.48		22.02	3

R3-G2 Tatami 4 16:15

Competitors	Kata	1T	1A	2T	2A	3T	3A	4T	4A	5T	5A	6T	6A	7T	7A	TEC	ATH	Extra	Total	Rank	
1	SEPTRIANI __ (GOJU ASS)	002 ANAN DAI	(7.4)	(7.6)	(7.6)	(7.4)	(7.2)	(7.0)	(7.2)	(7.2)	7.2	7.4	7.4	7.2	7.4	15.26	6.66		21.92	3	
2	MARZELLA_SEKAR DAMAYANTI (BANTEN)	009 CHIBANA NO KUSHANKU	7.6	(7.6)	(7.8)	7.6	(7.0)	(7.2)	7.6	7.6	(7.8)	(8.0)	(7.0)	(7.4)	7.6	7.6	15.96	6.84		22.8	1
3	NUR RIZKA_FAUZIAH (INKANAS)	002 ANAN DAI	(7.4)	(7.4)	(7.2)	(6.8)	(7.6)	7.4	7.4	7.4	(7.6)	(6.8)	(7.2)	7.4	7.4	15.54	6.66		22.2	2	
4	MARITZA EKA_RAHMADHANI (INKADO)	068 PAPUREN	7.2	7.2	(6.8)	(6.8)	7.2	7.2	7.0	(6.8)	(7.4)	(7.4)	(6.4)	7.0	(7.4)	(7.6)	14.98	6.42		21.4	4

R4 Bronze Medal Match 1 Tatami 3 16:35

Competitors	Kata	1T	1A	2T	2A	3T	3A	4T	4A	5T	5A	6T	6A	7T	7A	TEC	ATH	Extra	Total	Rank	
1	LAILA_NURUL HUMAIROH IN (JATENG)	002 ANAN DAI	(6.8)	(7.2)	7.2	(7.0)	7.2	7.2	(7.4)	(7.4)	(7.6)	(7.8)	7.4	7.4	(6.6)	7.4	15.26	6.6		21.86	2
2	SEPTRIANI __ (GOJU ASS)	008 CHATANYARA KUSHANKU	(7.2)	(7.6)	(7.4)	(7.4)	(7.6)	(7.4)	7.4	(7.6)	7.4	7.6	(7.6)	7.6	7.6	7.6	15.68	6.84		22.52	1

R4 Bronze Medal Match 2 Tatami 4 16:35

Competitors	Kata	1T	1A	2T	2A	3T	3A	4T	4A	5T	5A	6T	6A	7T	7A	TEC	ATH	Extra	Total	Rank
1	ANNISA_NUR HIDAYAT (GABDIKA)	092 SUPARINPEI	(7.2)	(7.6)	(7.6)	(7.4)	7.6	(7.4)	(7.4)	7.6	(7.8)	(7.8)	7.6	7.4	7.4	15.82	6.72		22.54	1
2	NUR RIZKA_FAUZIAH (INKANAS)	064 OHAN DAI	(7.0)	(7.4)	(7.4)	7.4	7.4	7.4	7.4	(7.6)	(7.6)	7.4	(7.6)	(6.8)	(7.2)	15.54	6.66		22.2	2

R4 Gold Medal Match Tatami 4 16:45

Competitors	Kata	1T	1A	2T	2A	3T	3A	4T	4A	5T	5A	6T	6A	7T	7A	TEC	ATH	Extra	Total	Rank	
1	SAMRANI_NUR AZIZAH IS (JAKARTA)	068 PAPUREN	7.8	(7.6)	(8.4)	(8.4)	(7.6)	(7.6)	7.8	7.6	7.8	7.6	(8.4)	(8.0)	(7.6)	7.6	16.38	6.84		23.22	1
2	MARZELLA_SEKAR DAMAYANTI (BANTEN)	068 PAPUREN	(8.0)	(8.0)	(8.6)	(8.4)	8.0	8.0	(7.4)	(7.2)	7.6	(7.4)	7.6	7.6	(7.4)	7.4	16.24	6.9		23.14	2

Results

1	SAMRANI NUR AZIZAH IS	DKI JAKARTA		INDONESIA
2	MARZELLA SEKAR DAMAYANTI	BANTEN		INDONESIA
3	SEPTRIANI	GOJU ASS		INDONESIA
3	ANNISA NUR HIDAYAT	GABDIKA SHITORYUKAI		INDONESIA
5	LAILA NURUL HUMAIROH IN	JAWA TENGAH		INDONESIA
5	NUR RIZKA FAUZIAH	INKANAS		INDONESIA
7	SINTA SOFIA MARDANI	SHOKAIDO		INDONESIA
7	MARITZA EKA RAHMADHANI	INKADO		INDONESIA

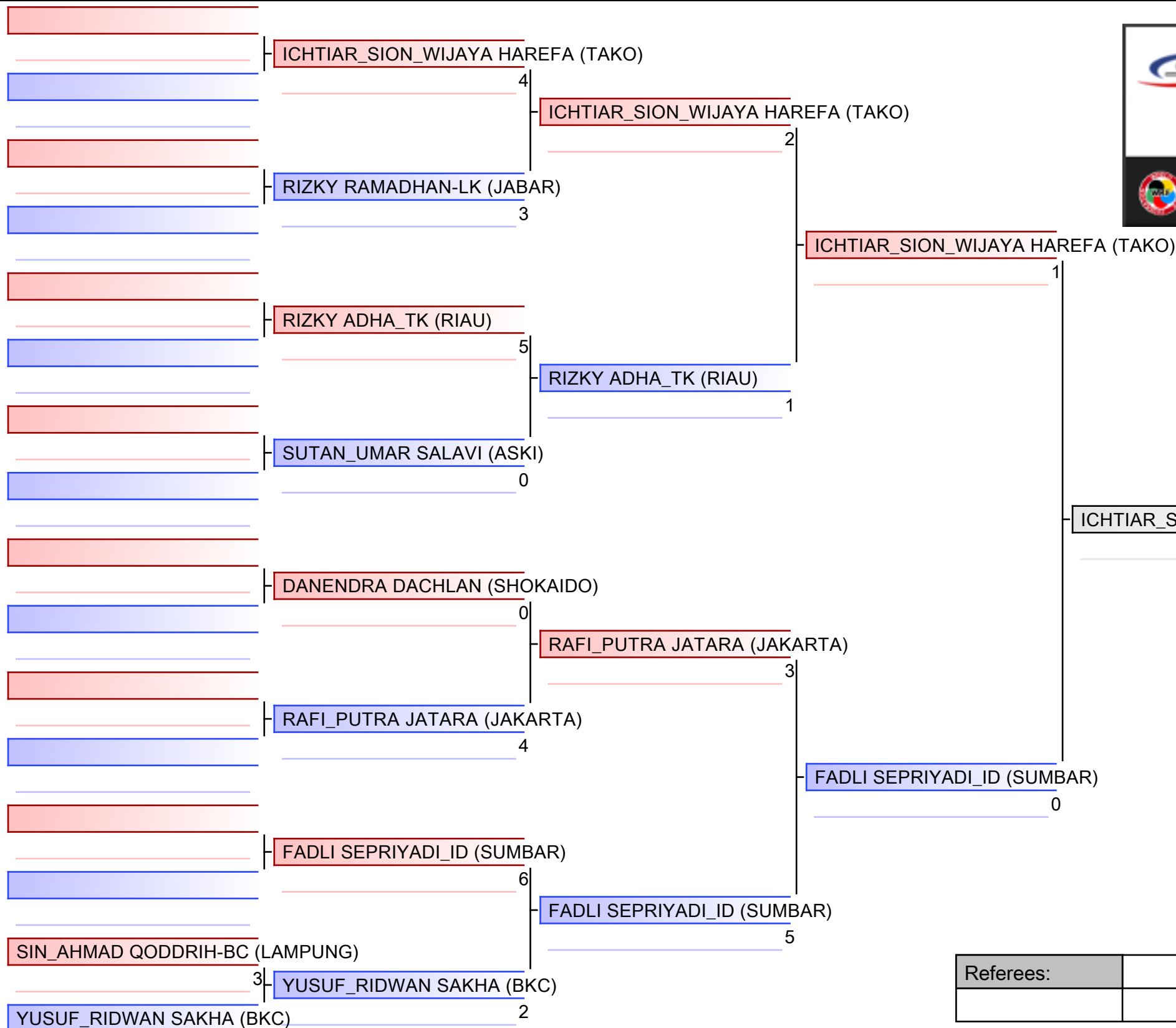

ICHTIAR_SION_WIJAYA HAREFA (TAKO)

- | |
|--------------------------------------|
| 1. MAXMILIANO EFENDI (INKAI) |
| 2. ICHTIAR_SION_WIJAYA HAREFA (TAKO) |
| 3. RIZKY ADHA_TK (RIAU) |
| 3. GERI_MAUFLANA HUTAPEA (KEPRI) |
| 5. FADLI SEPRIYADI_ID (SUMBAR) |
| 5. JOEL_MARTOGAP GULTOM (SHIROITE) |
| 7. RIZKY RAMADHAN-LK (JABAR) |
| 7. RIZKY ADITRI_ROZAL (LEMKARI) |

Referees:			

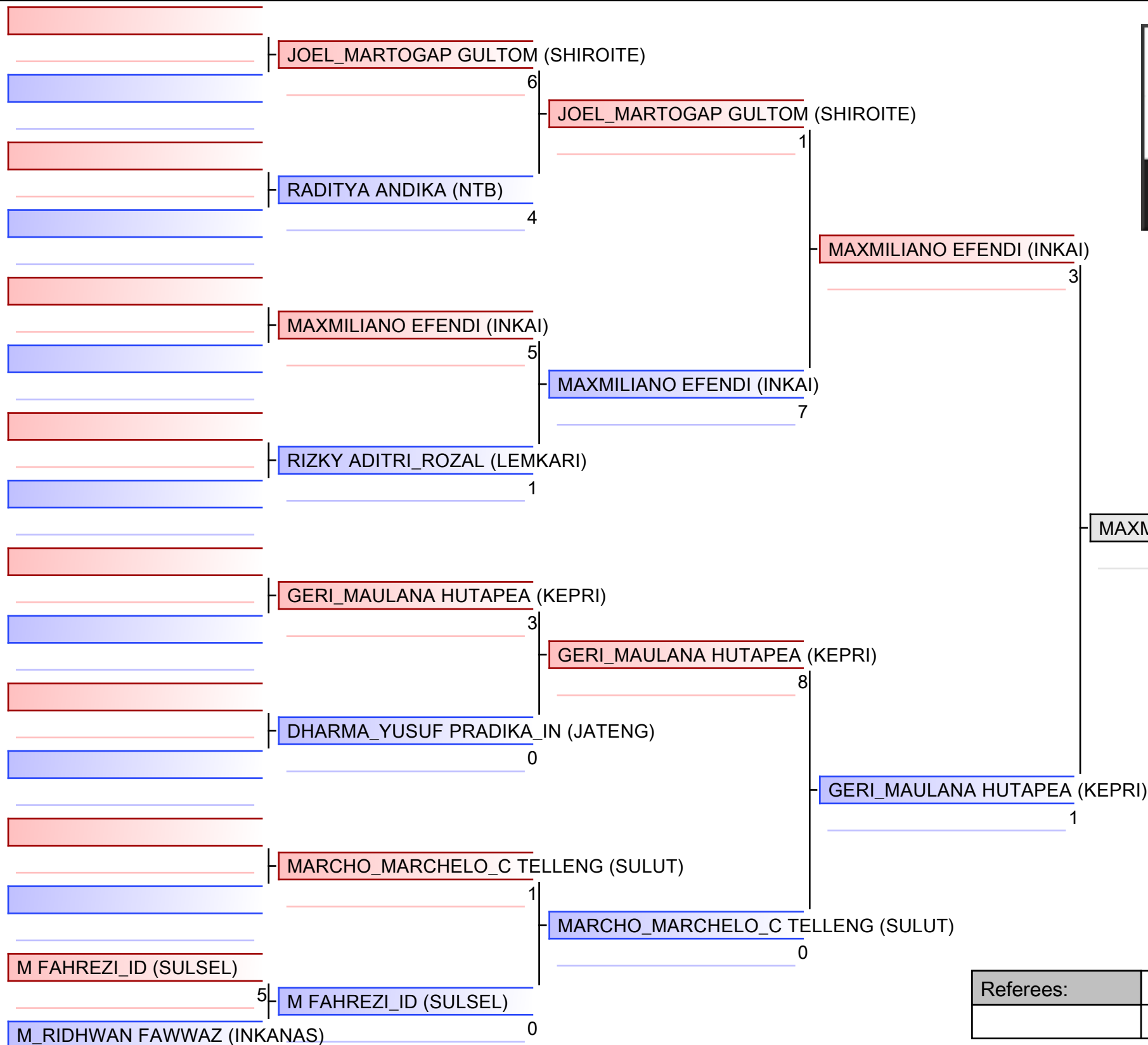

- | |
|--------------------------------------|
| 1. MAXMILIANO EFENDI (INKAI) |
| 2. ICHTIAR_SION_WIJAYA HAREFA (TAKO) |
| 3. RIZKY ADHA_TK (RIAU) |
| 3. GERI_MAUFLANA HUTAPEA (KEPRI) |
| 5. FADLI SEPRIYADI_ID (SUMBAR) |
| 5. JOEL_MARTOGAP GULTOM (SHIROITE) |
| 7. RIZKY RAMADHAN-LK (JABAR) |
| 7. RIZKY ADITRI_ROZAL (LEMKARI) |

Referees:			

JUNIOR KUMITE PUTRA -55 KG

KEJURNAS KARATE CADET, JUNIOR & U21 TAHUN 2021, INA

Tatami
2 11:35

Pool
1/2

FATHAM INSYIROH (GOJUKAI)

0 | MOCHAMAD_ALWI MARASABESSY (BUDOKAI)

MOCHAMAD_ALWI MARASABESSY (BUDOKAI)

4 | 0

M_BINTANG PUTRA_DEWA (LEMKARI)

0 | YOHANES MUHAMMAD (KKI)

YOHANES MUHAMMAD (KKI)

6 | 2

M_ADZAN MAULANA (SHINDOKA)

3 | ANDI_FAHMI FAHRI (NTB)

ANDI_FAHMI FAHRI (NTB)

4 | 2

GALIH_AGENG WINAHYU-IN (JABAR)

0 | MALIKI_BAQHA MAHENDA (BKC)

MALIKI_BAQHA MAHENDA (BKC)

2 | 2

MUH_DANI ODETUA (KALTARA)

0 | SATRYO_AHMAD ANANTA-IN (JATIM)

SATRYO_AHMAD ANANTA-IN (JATIM)

1 | 2

ARDIYAN SANDIKA (GOKASI)

2 | ARDIYAN SANDIKA (GOKASI)

YABES_PITHEIN AURI (GOJU ASS)

0 | 3

DHEWA_TRICIA ILMAULANA (INKADO)

3 | DHEWA_TRICIA ILMAULANA (INKADO)

AHMAD_ZAKI SUKIRMAN_IS (BENGKULU)

2 | 1

CHAIRUL_RACHMAT_SHIDDIQ NATA_PRAWIRA (KEISHINKAN)

0 | LALU_MUHAMMAD TATAS (PAPUA BARAT)

LALU_MUHAMMAD TATAS (PAPUA BARAT)

5 | 2

YOHANES MUHAMMAD (KKI)

3

YOHANES MUHAMMAD (KKI)

5

YOHANES MUHAMMAD (KKI)

LALU_MUHAMMAD TATAS (PAPUA BARAT)

0

LALU_MUHAMMAD TATAS (PAPUA BARAT)

3



- | |
|--|
| 1. JOSEP_MARIANO RATHZINGER (JAKARTA) |
| 2. YOHANES MUHAMMAD (KKI) |
| 3. ROMANUS LUTT_LUKAS_ID (PAPUA BARAT) |
| 3. MOCHAMAD_ALWI MARASABESSY (BUDOKAI) |
| 5. JOSEPH SIMATUPANG (INKANAS) |
| 5. LALU_MUHAMMAD TATAS (PAPUA BARAT) |
| 7. BAHRUL IHSAN-IN (DIY) |
| 7. ANDI_FAHMI FAHRI (NTB) |

Referees:			

JUNIOR KUMITE PUTRA -55 KG

KEJURNAS KARATE CADET, JUNIOR & U21 TAHUN 2021, INA

Tatami
1 11:40

Pool
2/2

ROMANUS LUTT_LUKAS_ID (PAPUA BARAT)

6 | ROMANUS LUTT_LUKAS_ID (PAPUA BARAT)

ANDI FAJRUL_KI (SULSEL)

3

LA_ODE_ALBARU WIJAYA (SULTRA)

0 | JOSEP_MARIANO RATHZINGER (JAKARTA)

JOSEP_MARIANO RATHZINGER (JAKARTA)

5

ANDRI LOHO-IS (GORONTALO)

6 | RAUL_GUNZALEZ PURBA (SHIROITE)

RAUL_GUNZALEZ PURBA (SHIROITE)

8

RIANTO DENIS_SENTOSA_ID (KALTIM)

1 | BHRUL IHSAN-IN (DIY)

BAHRUL IHSAN-IN (DIY)

4

DAFFA_FAALIH ANANTA (ASKI)

3 | DENNIS DHARMAWAN (JATENG)

DENNIS DHARMAWAN (JATENG)

7

DENNISH_RIZKITANANDO LITELNONI (LAMPUNG)

1 | GILANG_SATRIO SARAGIH (TAKO)

GILANG_SATRIO SARAGIH (TAKO)

2

MICHAEL_ANDREAN JOSUA SIBARANI (SHOKAIDO)

1 | ILHAM_ZACKY SAPUTRA_IS (RIAU)

ILHAM_ZACKY SAPUTRA_IS (RIAU)

2

MAIZEL_ISAK YUMPU (WADOKAI)

2 | JOSEPH SIMATUPANG (INKANAS)

JOSEPH SIMATUPANG (INKANAS)

2

JOSEP_MARIANO RATHZINGER (JAKARTA)

5

JOSEP_MARIANO RATHZINGER (JAKARTA)

2

BAHRUL IHSAN-IN (DIY)

2

JOSEP_MARIANO RATHZINGER (JAKARTA)

DENNIS DHARMAWAN (JATENG)

2

JOSEPH SIMATUPANG (INKANAS)

0

JOSEPH SIMATUPANG (INKANAS)

8



- | |
|--|
| 1. JOSEP_MARIANO RATHZINGER (JAKARTA) |
| 2. YOHANES MUHAMMAD (KKI) |
| 3. ROMANUS LUTT_LUKAS_ID (PAPUA BARAT) |
| 3. MOCHAMAD_ALWI MARASABESSY (BUDOKAI) |
| 5. JOSEPH SIMATUPANG (INKANAS) |
| 5. LALU_MUHAMMAD TATAS (PAPUA BARAT) |
| 7. BHRUL IHSAN-IN (DIY) |
| 7. ANDI_FAHMI FAHRI (NTB) |

Referees:			

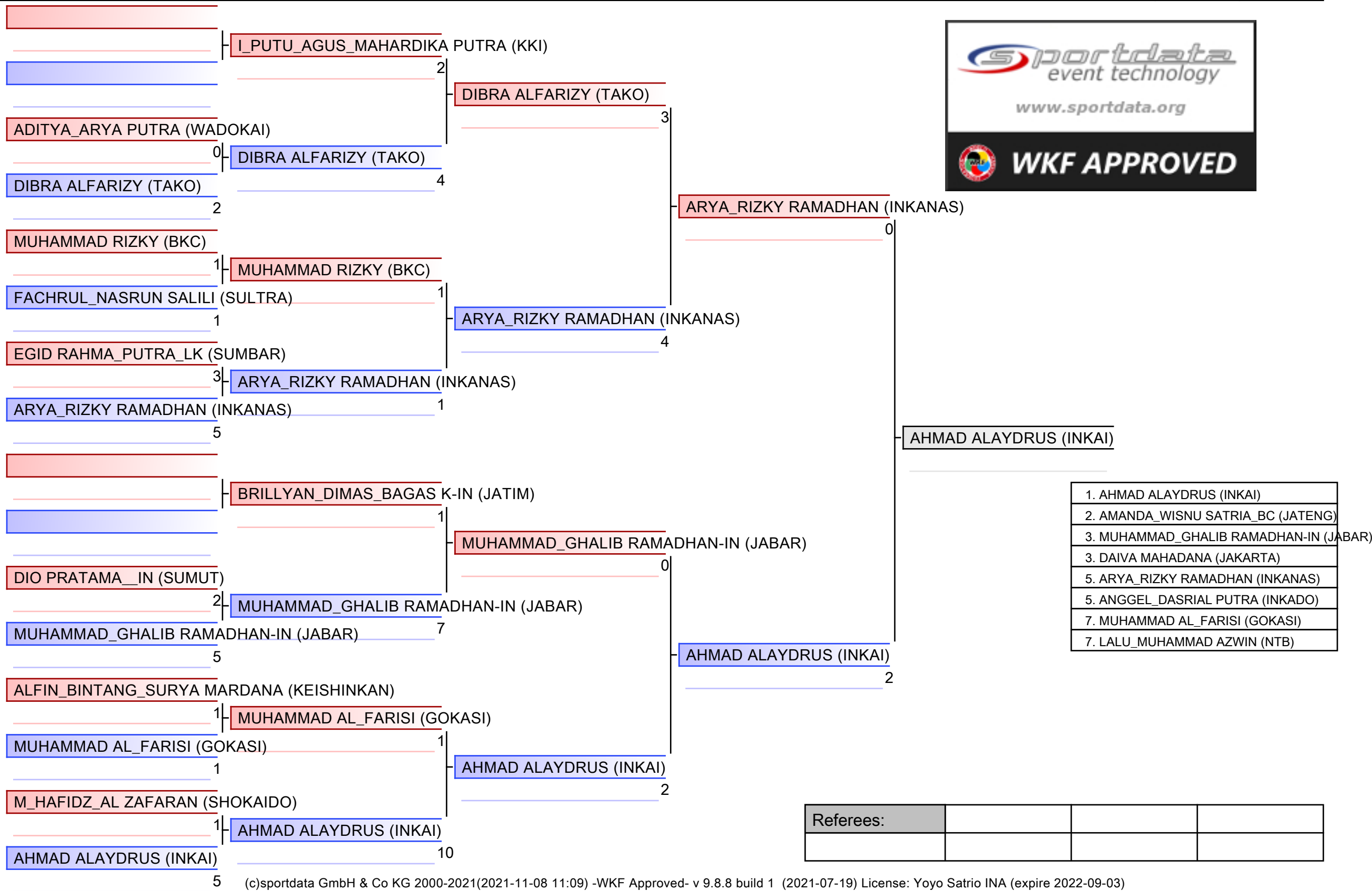

- | |
|--|
| 1. AHMAD ALAYDRUS (INKAI) |
| 2. AMANDA_WISNU SATRIA_BC (JATENG) |
| 3. MUHAMMAD_GHALIB RAMADHAN-IN (JABAR) |
| 3. DAIVA MAHADANA (JAKARTA) |
| 5. ARYA_RIZKY RAMADHAN (INKANAS) |
| 5. ANGGEL_DASRIAL PUTRA (INKADO) |
| 7. MUHAMMAD AL_FARISI (GOKASI) |
| 7. LALU_MUHAMMAD AZWIN (NTB) |

Referees:			

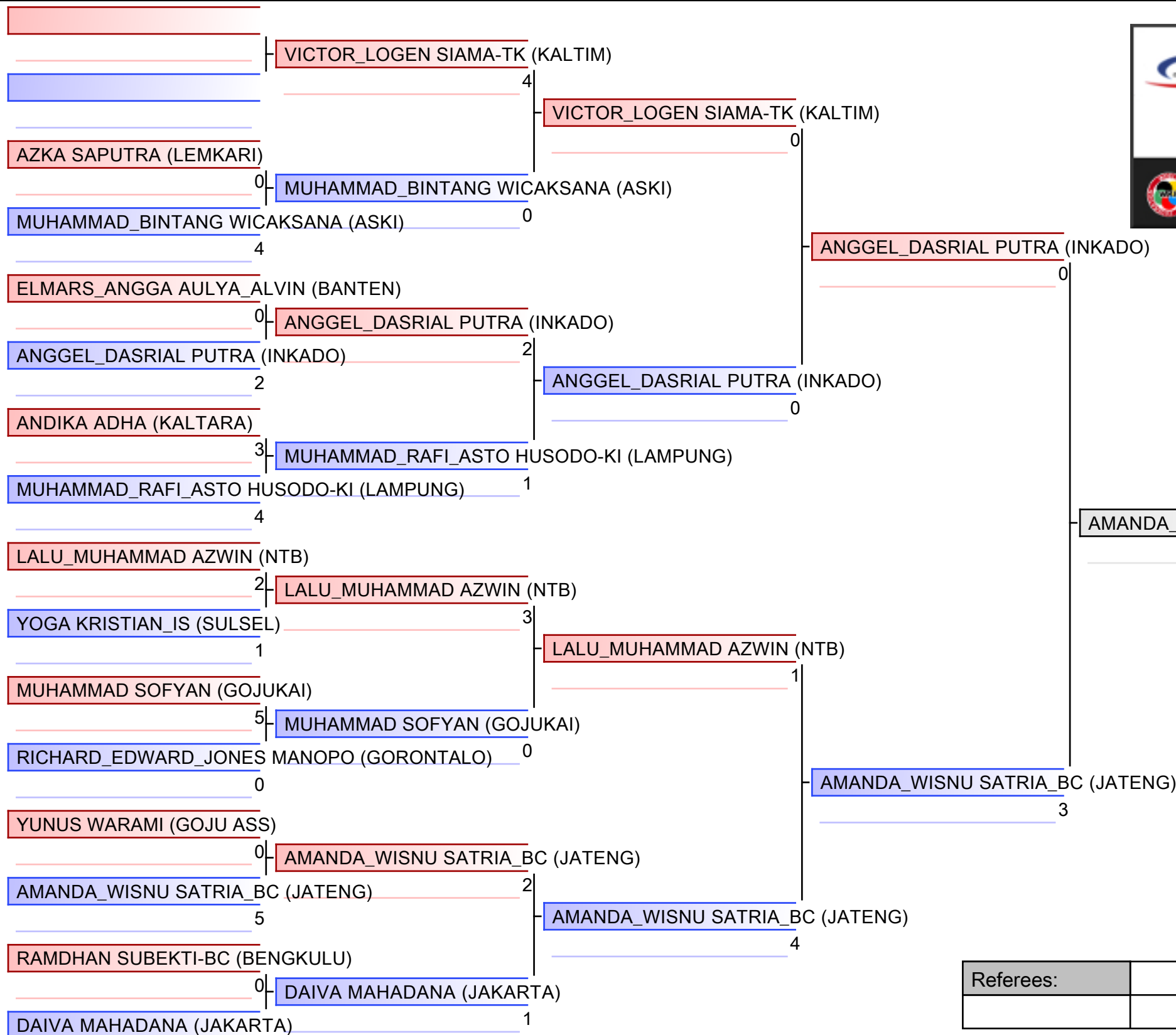

- | |
|--|
| 1. AHMAD ALAYDRUS (INKAI) |
| 2. AMANDA_WISNU SATRIA_BC (JATENG) |
| 3. MUHAMMAD_GHALIB RAMADHAN-IN (JABAR) |
| 3. DAIVA MAHADANA (JAKARTA) |
| 5. ARYA_RIZKY RAMADHAN (INKANAS) |
| 5. ANGGEL_DASRIAL PUTRA (INKADO) |
| 7. MUHAMMAD AL_FARISI (GOKASI) |
| 7. LALU_MUHAMMAD AZWIN (NTB) |

Referees:			

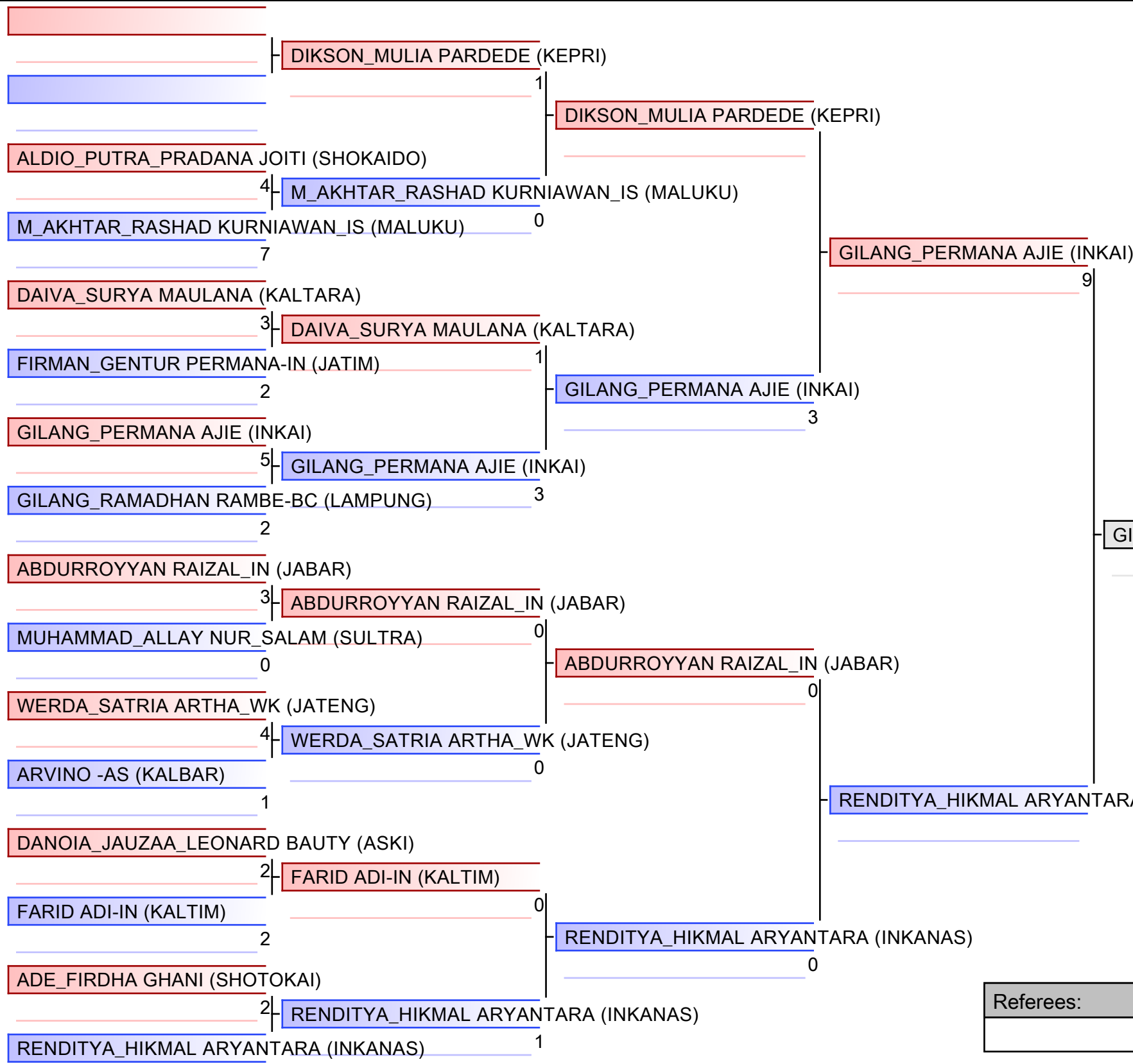

- | |
|---|
| 1. ANDHIKA_HULIO PRATAMA_BECKHAM, KI (SU) |
| 2. GILANG_PERMANA AJIE (INKAI) |
| 3. GILANG_RAMADHAN RAMBE-BC (LAMPUNG) |
| 3. AKBAR_TYO PAMUNGKAS (DIY) |
| 5. RENDITYA_HIKMAL ARYANTARA (INKANAS) |
| 5. ALIEF FEBRIANTO (JAKARTA) |
| 7. DIKSON_MULIA PARDEDE (KEPRI) |
| 7. SANDY ADRIAN_PUTRA (NTB) |

Referees:			

MUHAMMAD_ZHAFRAN KAMIL (BUDOKAI)

4 | AKBAR_TYO PAMUNGKAS (DIY)

AKBAR_TYO PAMUNGKAS (DIY) 1

0

ANDHIKA_HULIO PRATAMA_BECKHAM_KI (SUMSEL)

ANDHIKA_HULIO PRATAMA_BECKHAM_KI (SUMSEL)

M_FATAHILLAH_AMRI SHIDQI (WADOKAI) 5

BAMBANG PRIYAMBODO_IN (BANTEN)

2 | BAMBANG PRIYAMBODO_IN (BANTEN)

M_YUSMAR SYAHRANI_SANDUAN_IN (SULSEL) 1

0

IAN_FALIFINO TOBING_TK (RIAU)

1 | SANDY ADRIAN_PUTRA (NTB)

SANDY ADRIAN_PUTRA (NTB) 2

2

DZAKY_TRI UTOMO (LEMKARI)

4 | DZAKY_TRI UTOMO (LEMKARI)

FAIQ MUHAMMAD (BENGKULU) 2

0

ABDURROYAN RAIZAL_IN (JABAR)

MUHAMMAD_RIFALDI APRILIAN (BKC)

MUHAMMAD_RIFALDI APRILIAN (BKC) 0

YOGA ARISANDI_IS (SUMBAR)

8 | YOGA ARISANDI_IS (SUMBAR)

RAFIANO_JAVIER JUMHAWAN (INKADO) 0

0

MICHAEL_DIOR_PEPAYOSA SEBAYANG (KEISHINKAN)

1 | ALIEF FEBRIANTO (JAKARTA)

ALIEF FEBRIANTO (JAKARTA) 2

4

ANDHIKA_HULIO PRATAMA_BECKHAM_KI (SUMSEL) 2

ANDHIKA_HULIO PRATAMA_BECKHAM_KI (SUMSEL) 0

ANDHIKA_HULIO PRATAMA_BECKHAM_KI (SUMSEL)

ALIEF FEBRIANTO (JAKARTA) 7



- | |
|--|
| 1. ANDHIKA_HULIO PRATAMA_BECKHAM_KI (SUMSEL) |
| 2. GILANG_PERMANA AJIE (INKAI) |
| 3. GILANG_RAMADHAN RAMBE-BC (LAMPUNG) |
| 3. AKBAR_TYO PAMUNGKAS (DIY) |
| 5. RENDITYA_HIKMAL ARYANTARA (INKANAS) |
| 5. ALIEF FEBRIANTO (JAKARTA) |
| 7. DIKSON_MULIA PARDEDE (KEPRI) |
| 7. SANDY ADRIAN_PUTRA (NTB) |

Referees:			

JUNIOR KUMITE PUTRA -76 KG

KEJURNAS KARATE CADET, JUNIOR & U21 TAHUN 2021, INA

Tatami
5 09:00

Pool
1/1

M_RIZKY -BC (LAMPUNG)

7 | M_RIZKY -BC (LAMPUNG)

M_FADLAN KHAIDIR_ID (SULSEL)

0 | NATHANIEL ABIMANYU (ASKI)

AKMAL DHARA (GABDIKA)

0 | NATHANIEL ABIMANYU (ASKI)

NATHANIEL ABIMANYU (ASKI)

8 | NATHANIEL ABIMANYU (ASKI)

MUHAMMAD_WAFI ROCHMAN_IN (JATENG)

4 | MUHAMMAD_WAFI ROCHMAN_IN (JATENG)

NAYO_BUZJANI_IRCHAMSYAH NAHAWAN (WADOKAI)

3 | MUHAMMAD GIBRAN (INKANAS)

REZI FEBRIAN_LK (SUMBAR)

1 | MUHAMMAD GIBRAN (INKANAS)

MUHAMMAD GIBRAN (INKANAS)

1 | MUHAMMAD GIBRAN (INKANAS)

FAHRIZA_ABDUL GHANI (FUNAKOSHI)

0 | RIFKY ADRIANSYAH (LEMKARI)

RIFKY ADRIANSYAH (LEMKARI)

4 | BIMBIM MAULANA_IBRAHIM_BC (JABAR)

BIMBIM MAULANA_IBRAHIM_BC (JABAR)

6 | BIMBIM MAULANA_IBRAHIM_BC (JABAR)

I_MD_SATRIA_DALEM WIDHIANTARA (BALI)

5 | MUHAMMAD MIGUEL_LIONEL_PUTRO (JAKARTA)

M_RAKHANSA_DEWA D-IS (JATIM)

2 | SYAHLA_HAIKAL AZZAIKRA (BANTEN)

SYAHLA_HAIKAL AZZAIKRA (BANTEN)

4 | MUHAMMAD MIGUEL_LIONEL_PUTRO (JAKARTA)

IRVING_GERALD_MARK SOEPARMAN (SULUT)

0 | MUHAMMAD MIGUEL_LIONEL_PUTRO (JAKARTA)

MUHAMMAD MIGUEL_LIONEL_PUTRO (JAKARTA)

10 | MUHAMMAD MIGUEL_LIONEL_PUTRO (JAKARTA)

8

Final

NATHANIEL ABIMANYU (ASKI)

4 | NATHANIEL ABIMANYU (ASKI)

NATHANIEL ABIMANYU (ASKI)



- | |
|---|
| 1. NATHANIEL ABIMANYU (ASKI) |
| 2. MUHAMMAD MIGUEL_LIONEL_PUTRO (JAKARTA) |
| 3. MUHAMMAD GIBRAN (INKANAS) |
| 3. BIMBIM MAULANA_IBRAHIM_BC (JABAR) |
| 5. M_RIZKY -BC (LAMPUNG) |
| 5. SYAHLA_HAIKAL AZZAIKRA (BANTEN) |
| 7. AKMAL DHARA (GABDIKA) |
| 7. IRVING_GERALD_MARK SOEPARMAN (SULUT) |

Referees:			

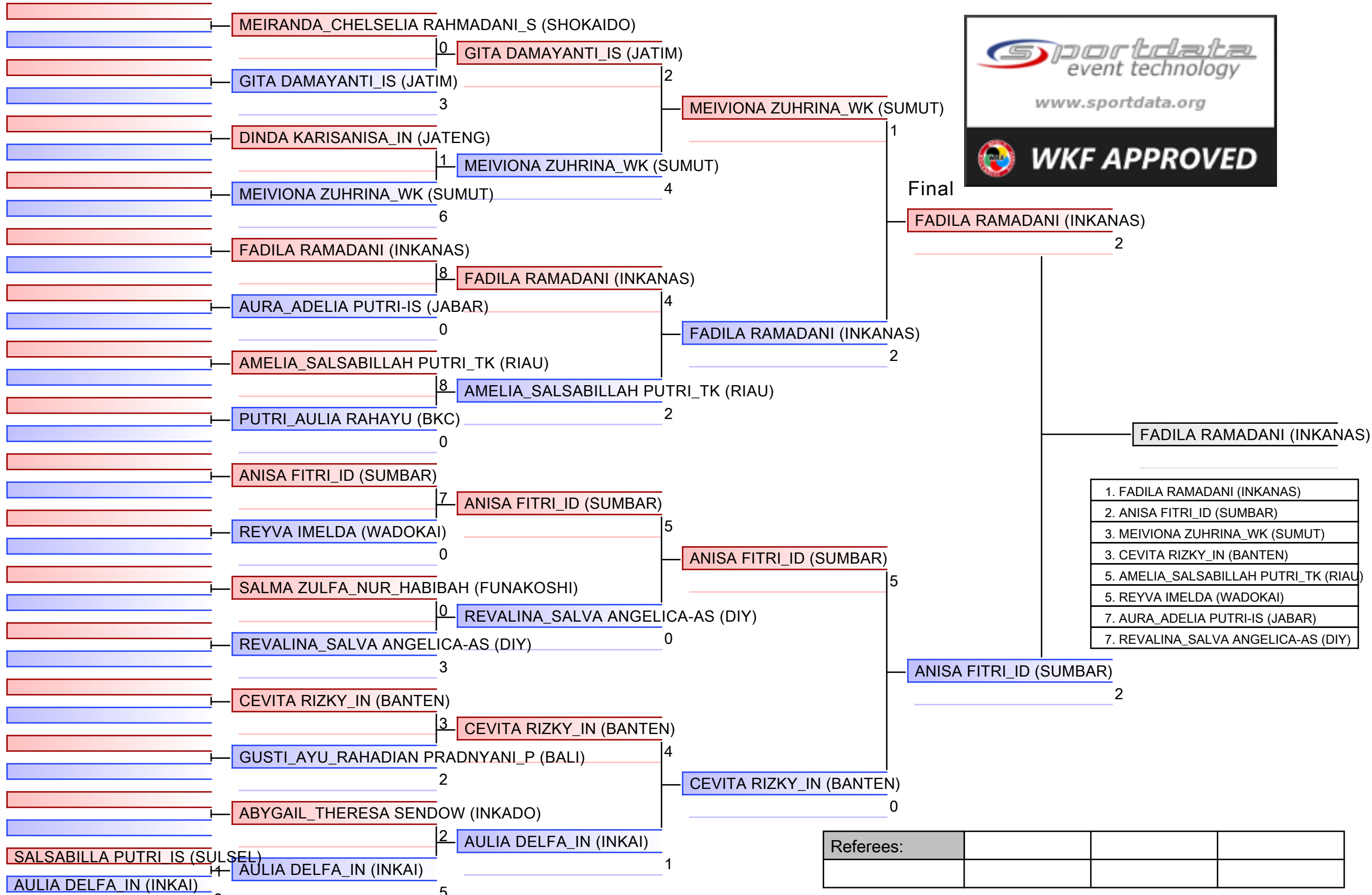

Referees:			

JUNIOR KUMITE PUTRI -48 KG

KEJURNAS KARATE CADET, JUNIOR & U21 TAHUN 2021, INA

Tatami
4 12:35

Pool
1/2

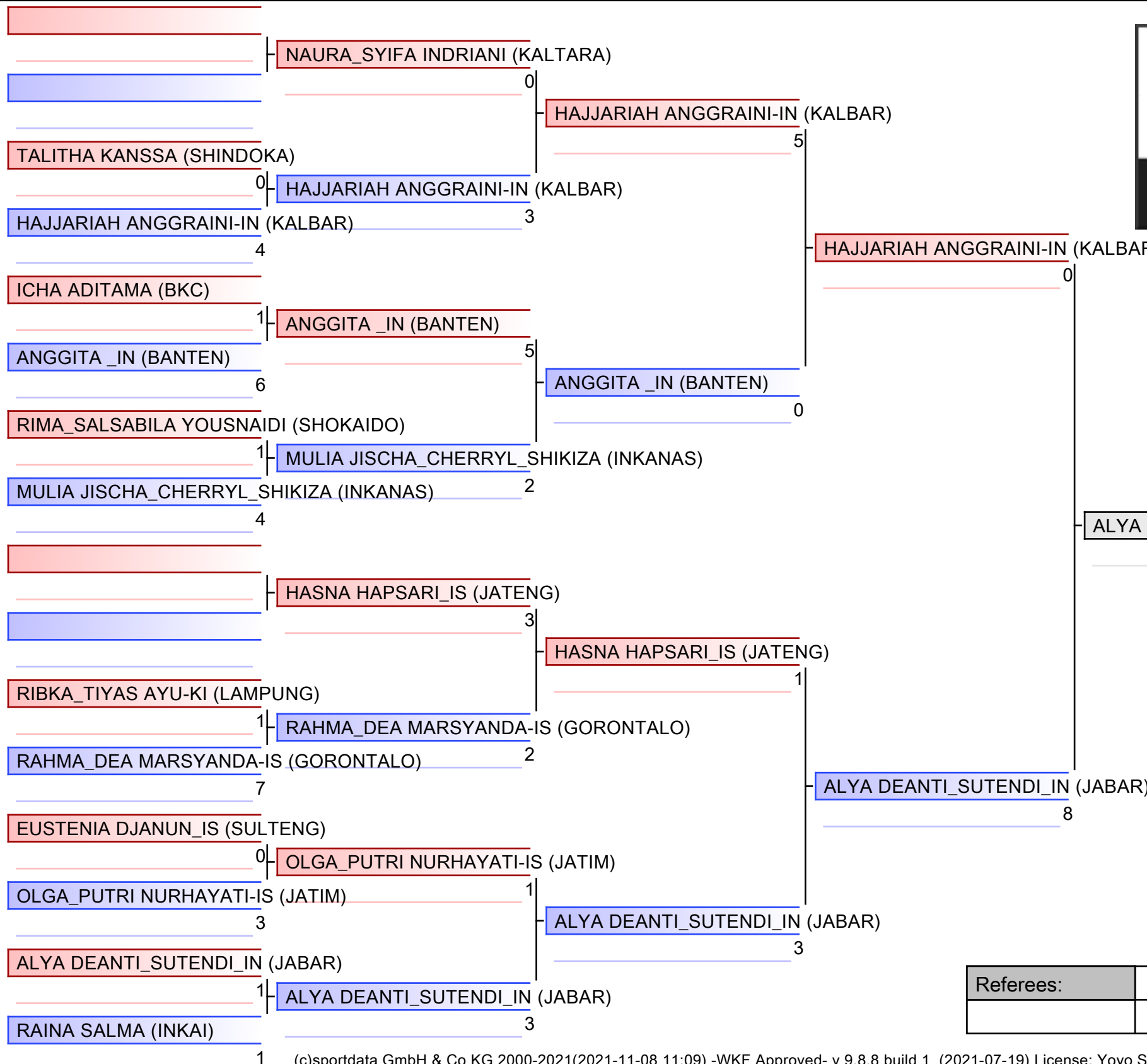

- | |
|------------------------------------|
| 1. FARHAH_DWI ALYAWATI (JAKARTA) |
| 2. ALYA DEANTI_SUTENDI_IN (JABAR) |
| 3. BENEDICTA_RIEDA LARASATI (ASKI) |
| 3. RAINA SALMA (INKAI) |
| 5. YOHANA_ADELL REGAR (SULUT) |
| 5. HAJJARIAH ANGGRAINI-IN (KALBAR) |
| 7. DAMAYANTI -KI (KALTIM) |
| 7. HASNA HAPSARI_IS (JATENG) |

Referees:			

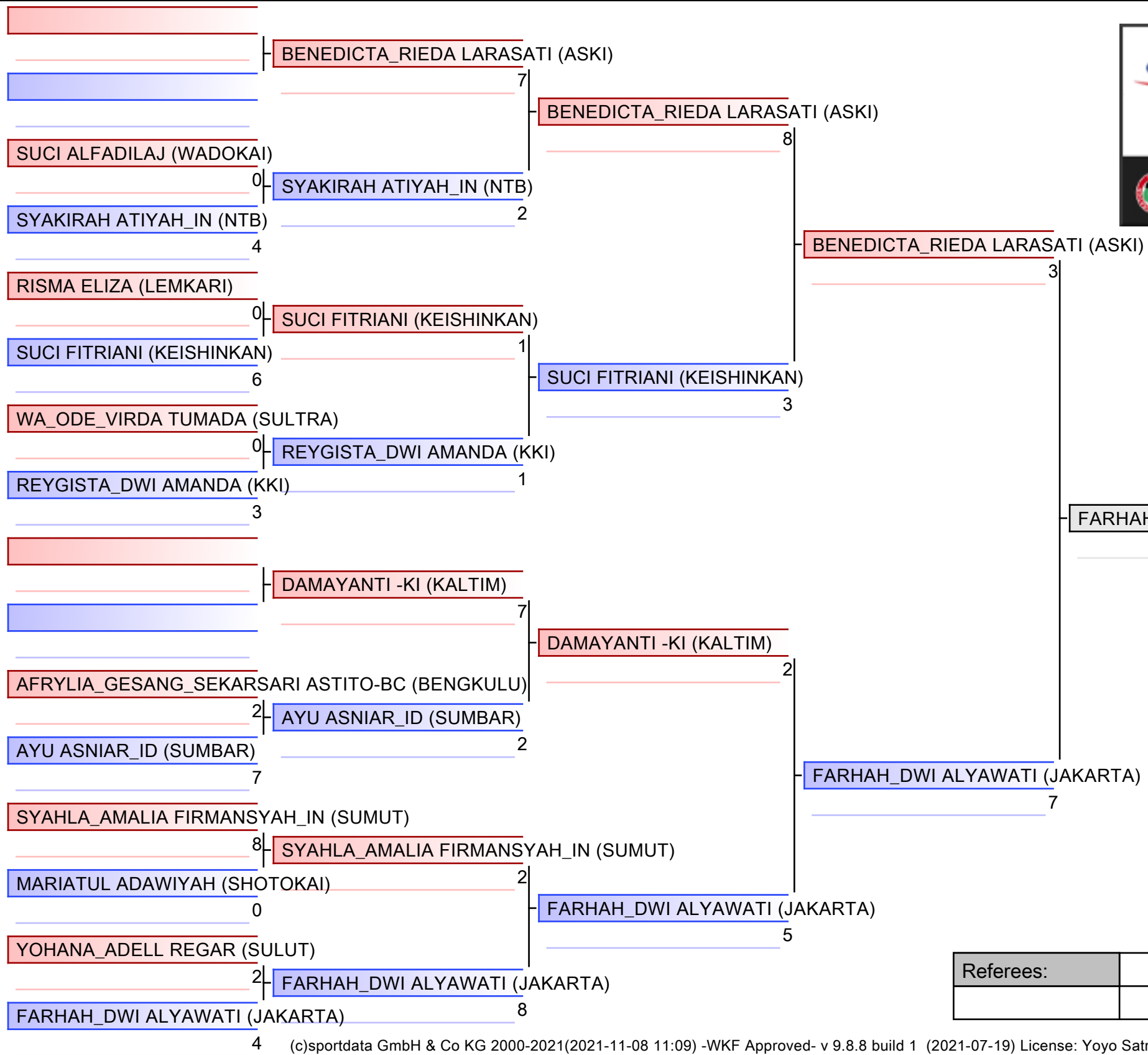

- | |
|------------------------------------|
| 1. FARHAH_DWI ALYAWATI (JAKARTA) |
| 2. ALYA DEANTI_SUTENDI_IN (JABAR) |
| 3. BENEDICTA_RIEDA LARASATI (ASKI) |
| 3. RAINA SALMA (INKAI) |
| 5. YOHANA_ADELL REGAR (SULUT) |
| 5. HAJJARIAH ANGGRAINI-IN (KALBAR) |
| 7. DAMAYANTI -KI (KALTIM) |
| 7. HASNA HAPSARI_IS (JATENG) |

Referees:			

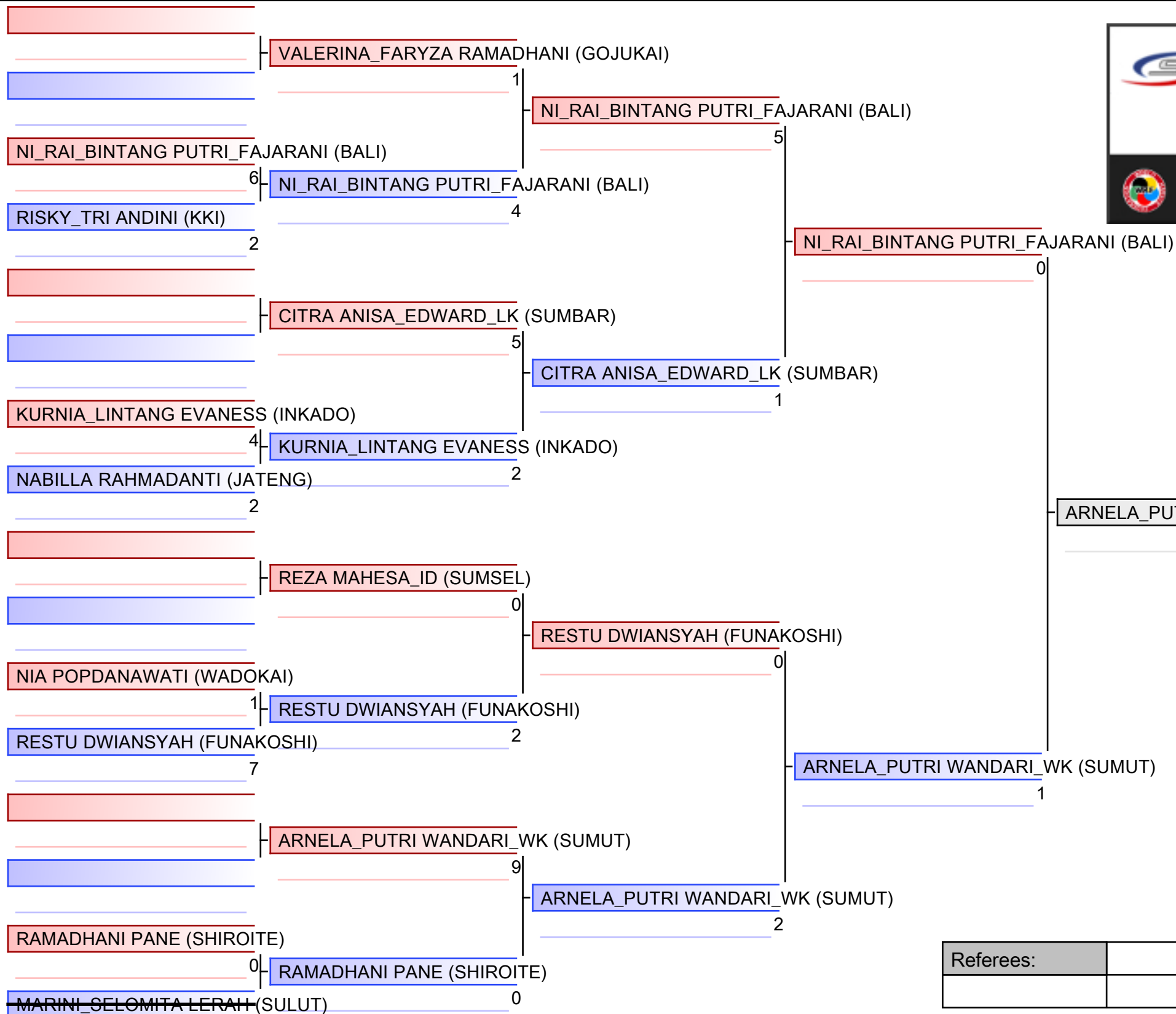

- | |
|---|
| 1. AZFA AULIA_IS (JABAR) |
| 2. ARNELA_PUTRI WANDARI_WK (SUMUT) |
| 3. NI_RAI_BINTANG PUTRI_FAJARANI (BALI) |
| 3. SALSA_G_P WAHONO-IKD (SULUT) |
| 5. RAMADHANI PANE (SHIROITE) |
| 5. FINALIRIN_ (INKANAS) |
| 7. RESTU DWIANSYAH (FUNAKOSHI) |
| 7. CHIKITA HANDRIANA (BANTEN) |

Referees:			

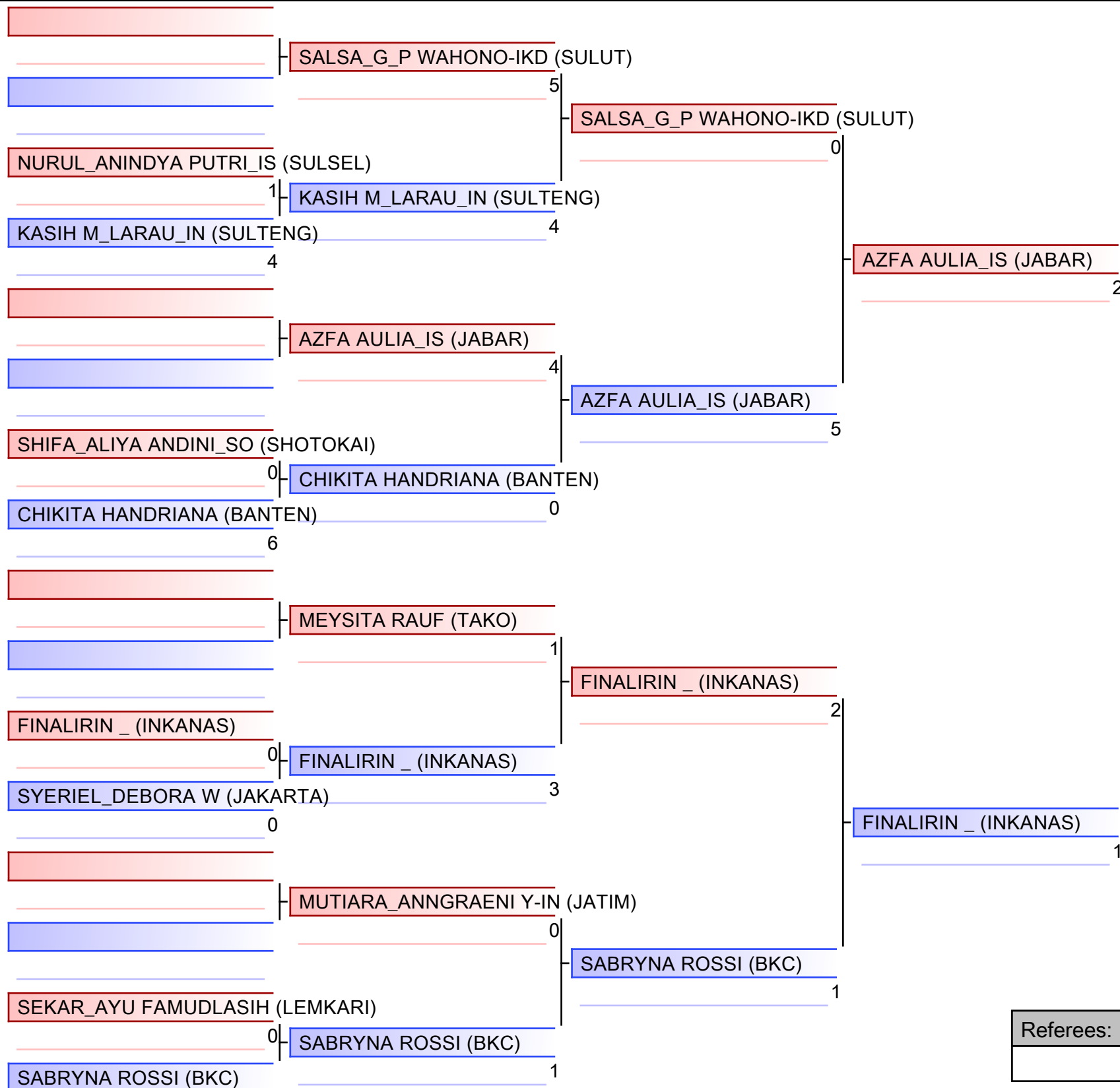

AZFA AULIA_IS (JABAR)

- | |
|---|
| 1. AZFA AULIA_IS (JABAR) |
| 2. ARNELA_PUTRI WANDARI_WK (SUMUT) |
| 3. NI_RAI_BINTANG PUTRI_FAJARANI (BALI) |
| 3. SALSA_G_P WAHONO-IKD (SULUT) |
| 5. RAMADHANI PANE (SHIROITE) |
| 5. FINALIRIN _ (INKANAS) |
| 7. RESTU DWIANSYAH (FUNAKOSHI) |
| 7. CHIKITA HANDRIANA (BANTEN) |

Referees:			

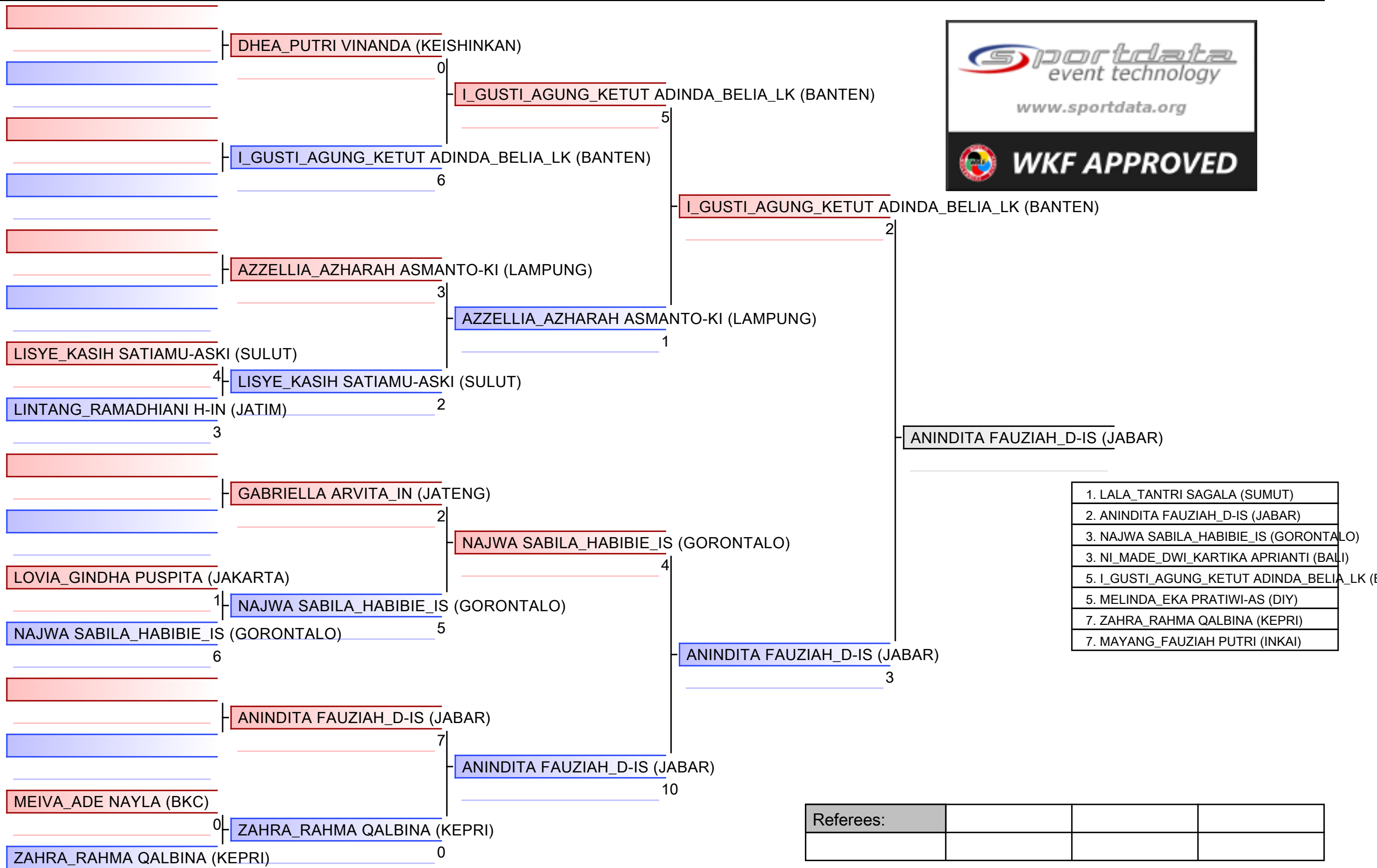

- | |
|---|
| 1. LALA_TANTRI SAGALA (SUMUT) |
| 2. ANINDITA FAUZIAH_D-IS (JABAR) |
| 3. NAJWA SABILA_HABIBIE_IS (GORONTALO) |
| 3. NI_MADE_DWI_KARTIKA APRIANTI (BALI) |
| 5. I_GUSTI_AGUNG_KETUT ADINDA_BELIA_LK (BANTEN) |
| 5. MELINDA_EKA PRATIWI-AS (DIY) |
| 7. ZAHRA_RAHEMA QALBINA (KEPRI) |
| 7. MAYANG_FAUZIAH PUTRI (INKAI) |

Referees:			

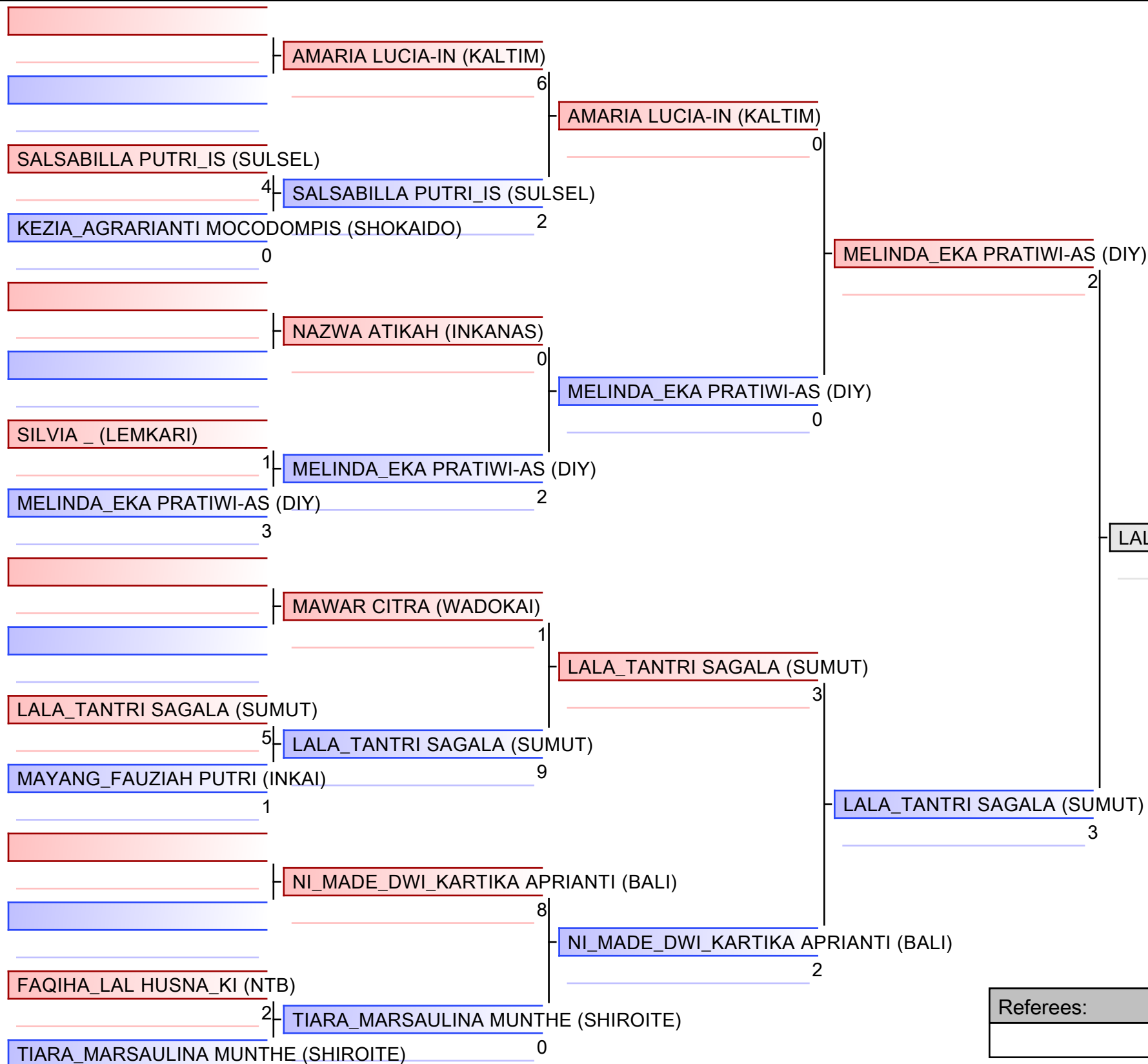

- | |
|--|
| 1. LALA_TANTRI SAGALA (SUMUT) |
| 2. ANINDITA FAUZIAH_D-IS (JABAR) |
| 3. NAJWA SABILA_HABIBIE_IS (GORONTALO) |
| 3. NI_MADE_DWI_KARTIKA APRIANTI (BALI) |
| 5. I_GUSTI_AGUNG_KETUT ADINDA_BELIA_LK (B) |
| 5. MELINDA_EKA PRATIWI-AS (DIY) |
| 7. ZAHRA_RAHMA QALBINA (KEPRI) |
| 7. MAYANG_FAUZIAH PUTRI (INKAI) |

Referees:			

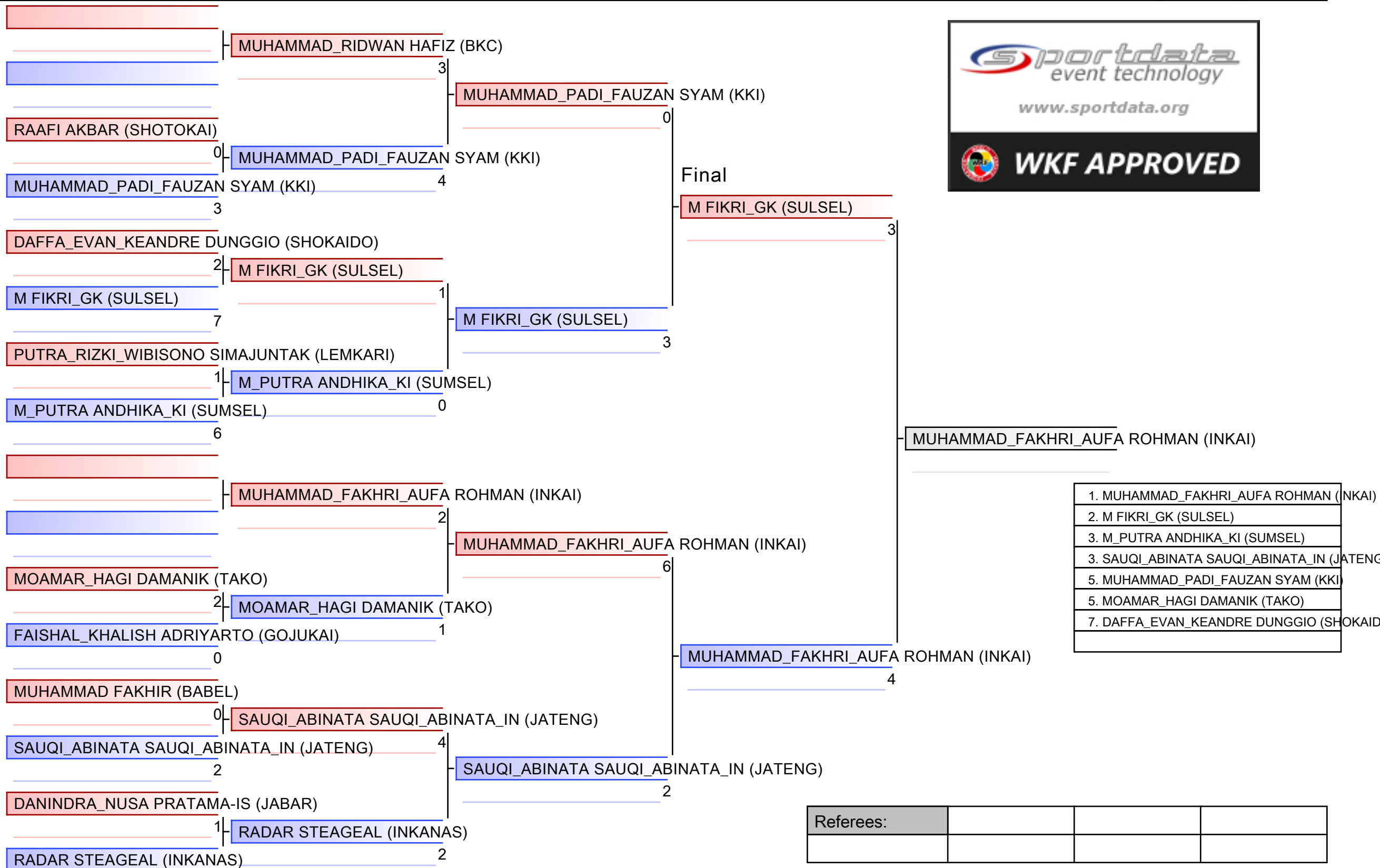

- | |
|--|
| 1. MUHAMMAD_FAKHRI_AUFA ROHMAN (INKAI) |
| 2. M FIKRI_GK (SULSEL) |
| 3. M_PUTRA ANDHIKA_KI (SUMSEL) |
| 3. SAUQI_ABINATA SAUQI_ABINATA_IN (JATENG) |
| 5. MUHAMMAD_PADI_FAUZAN SYAM (KKI) |
| 5. MOAMAR_HAGI DAMANIK (TAKO) |
| 7. DAFFA_EVAN_KEANDRE DUNGGIO (SHOKAIDO) |

Referees:			

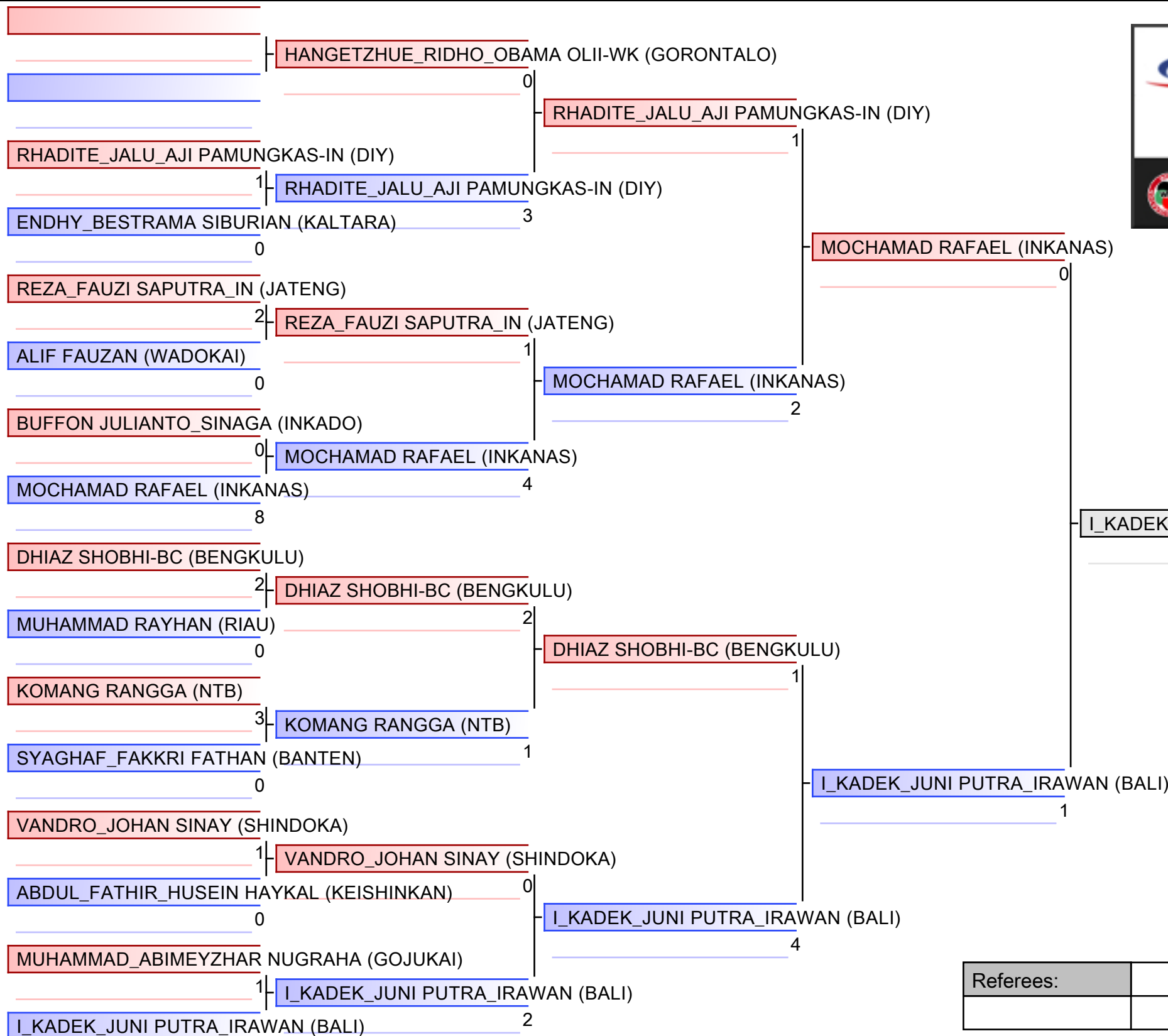

- | |
|--|
| 1. I_KADEK_JUNI PUTRA_IRAWAN (BALI) |
| 2. ARIEF WIDJAKSONO (SULSEL) |
| 3. MOCHAMAD RAFAEL (INKANAS) |
| 3. FAHREL_APRIYANSYAH AMARTHA-KI (LAMPUNG) |
| 5. DHIAZ SHOBHI-BC (BENGKULU) |
| 5. MORI_DAFFA_HILMAN ROSYAD_KI (JABAR) |
| 7. MUHAMMAD_ABIMEYZHAR NUGRAHA (GOJUKAI) |
| 7. MUHAMMAD FARKHAM (LEMKARI) |

Referees:			

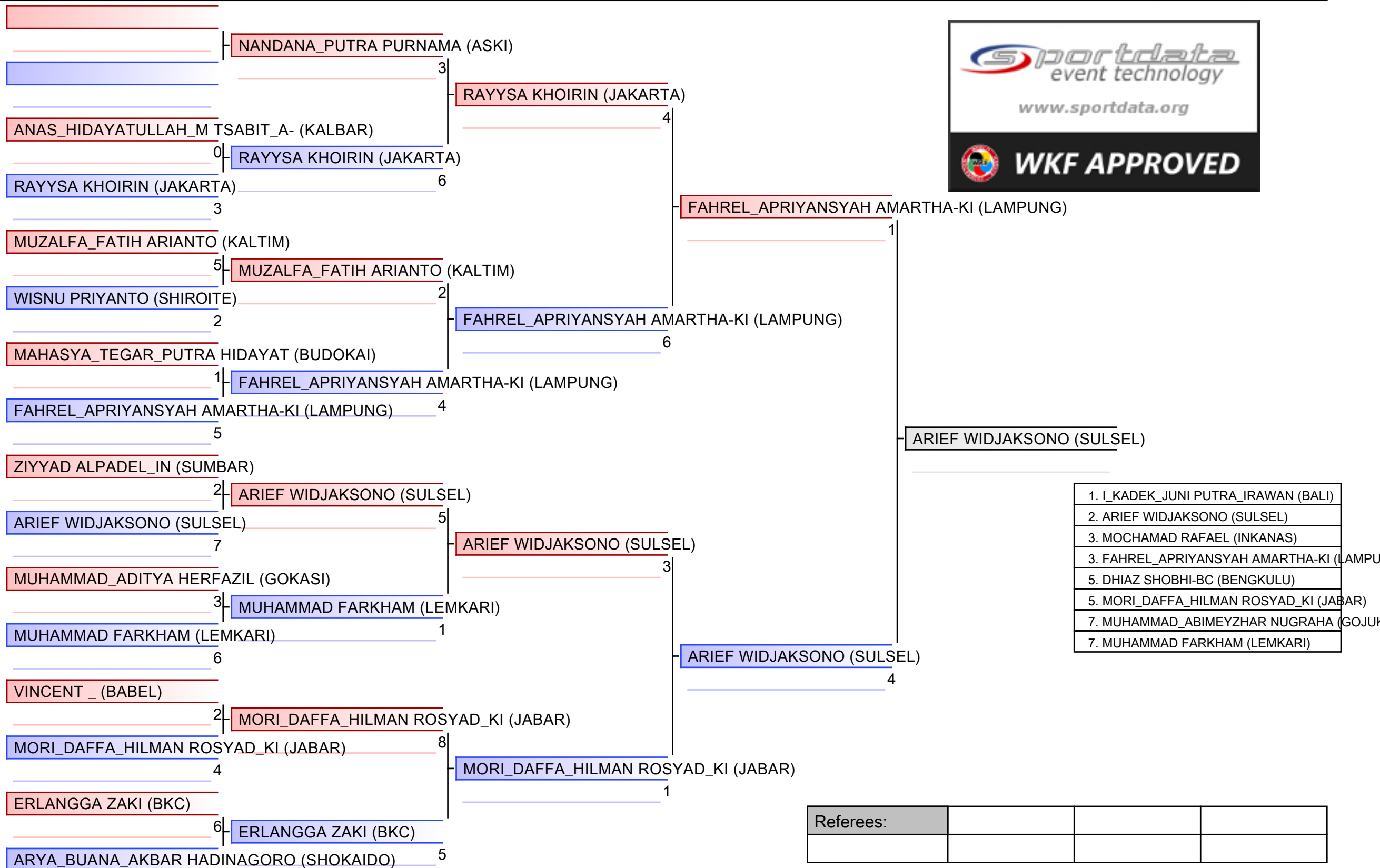

- | |
|--|
| 1. I_KADEK_JUNI PUTRA_IRAWAN (BALI) |
| 2. ARIEF WIDJAKSONO (SULSEL) |
| 3. MOCHAMAD RAFAEL (INKANAS) |
| 3. FAHREL_APRIYANSYAH AMARTHA-KI (LAMPUNG) |
| 5. DHIAZ SHOBHI-BC (BENGKULU) |
| 5. MORI_DAFFA_HILMAN ROSYAD_KI (JABAR) |
| 7. MUHAMMAD_ABIMEYZHAR NUGRAHA (GOJUK) |
| 7. MUHAMMAD FARKHAM (LEMKARI) |

Referees:			

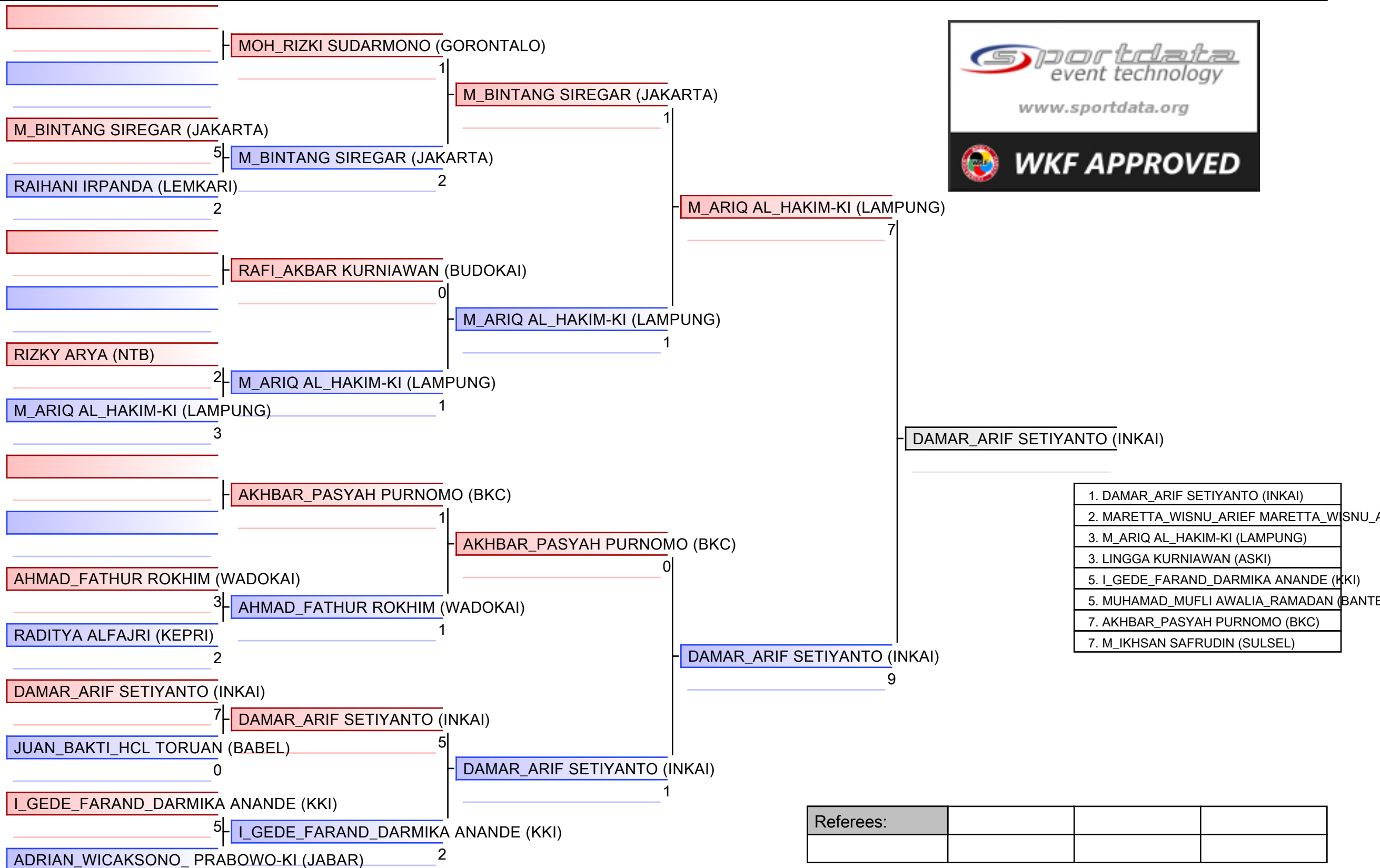

- | |
|--|
| 1. DAMAR_ARIF SETIYANTO (INKAI) |
| 2. MARETTA_WISNU_ARIEF MARETTA_WISNU_A |
| 3. M_ARIQ AL_HAKIM-KI (LAMPUNG) |
| 3. LINGGA KURNIAWAN (ASKI) |
| 5. I_GEDE_FARAND_DARMIKA ANANDE (KKI) |
| 5. MUHAMAD_MUFLI AWALIA_RAMADAN (BANTE |
| 7. AKHBAR_PASYAH PURNOMO (BKC) |
| 7. M_IKHSAN SAFRUDIN (SULSEL) |

Referees:			

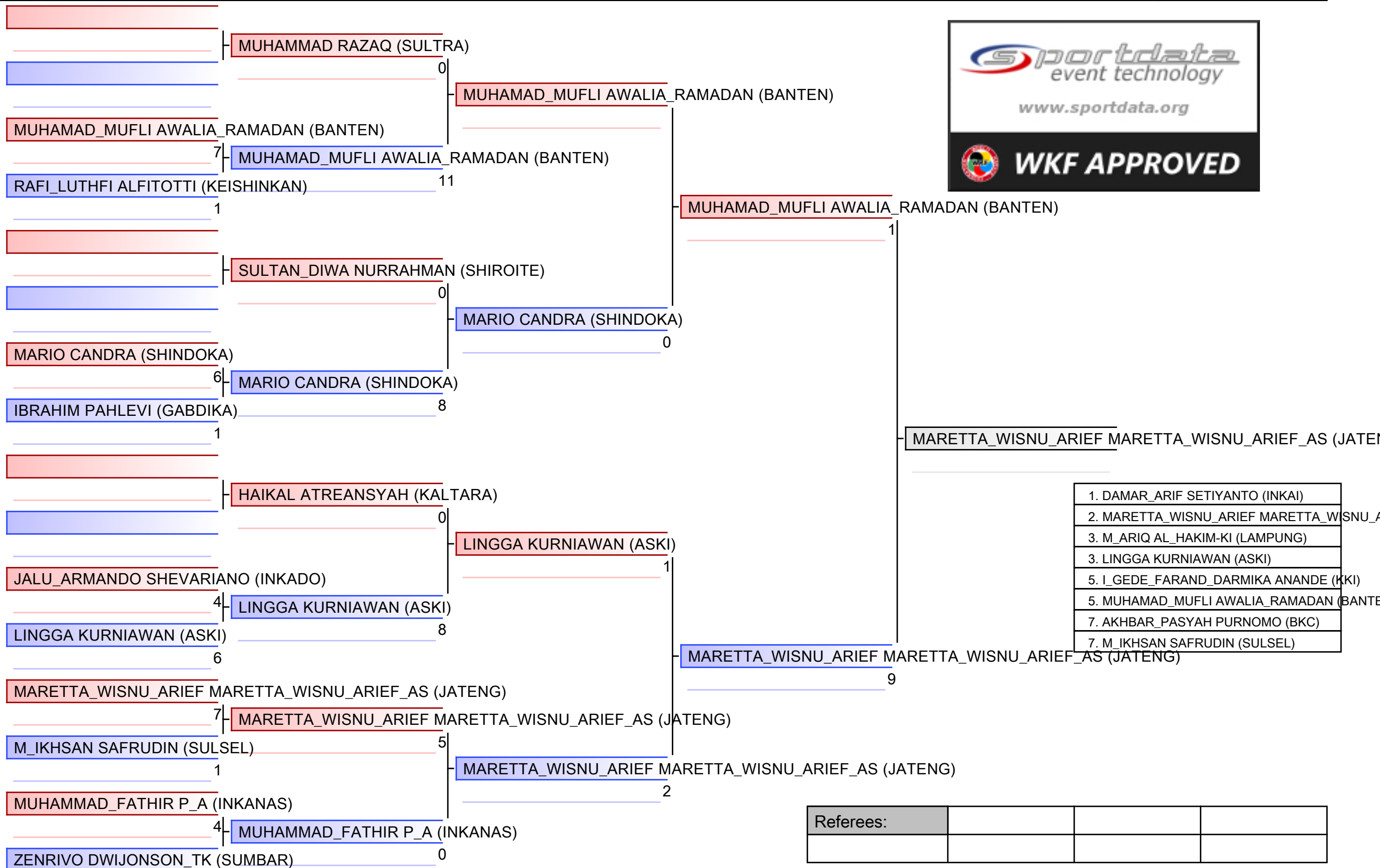

- | |
|--|
| 1. DAMAR_ARIF SETIYANTO (INKAI) |
| 2. MARETTA_WISNU_ARIEF MARETTA_WISNU_A |
| 3. M_ARIQ AL_HAKIM-KI (LAMPUNG) |
| 3. LINGGA KURNIAWAN (ASKI) |
| 5. I_GEDE_FARAND_DARMIKA ANANDE (KKI) |
| 5. MUHAMAD_MUFLI AWALIA_RAMADAN (BANTE |
| 7. AKHBAR_PASYAH PURNOMO (BKC) |
| 7. M_ IKHSAN SAFRUDIN (SULSEL) |

Referees:			

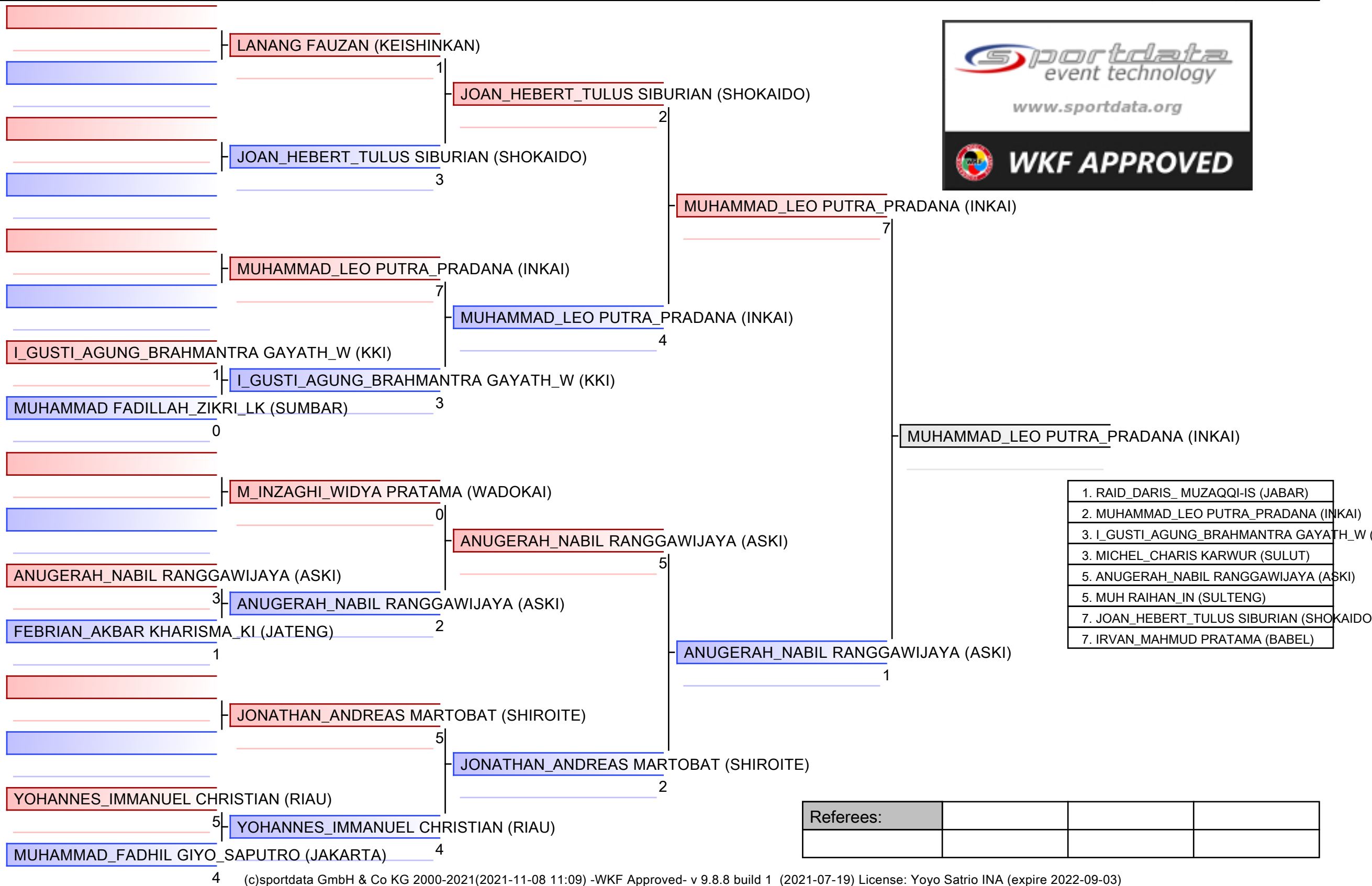

Referees:			

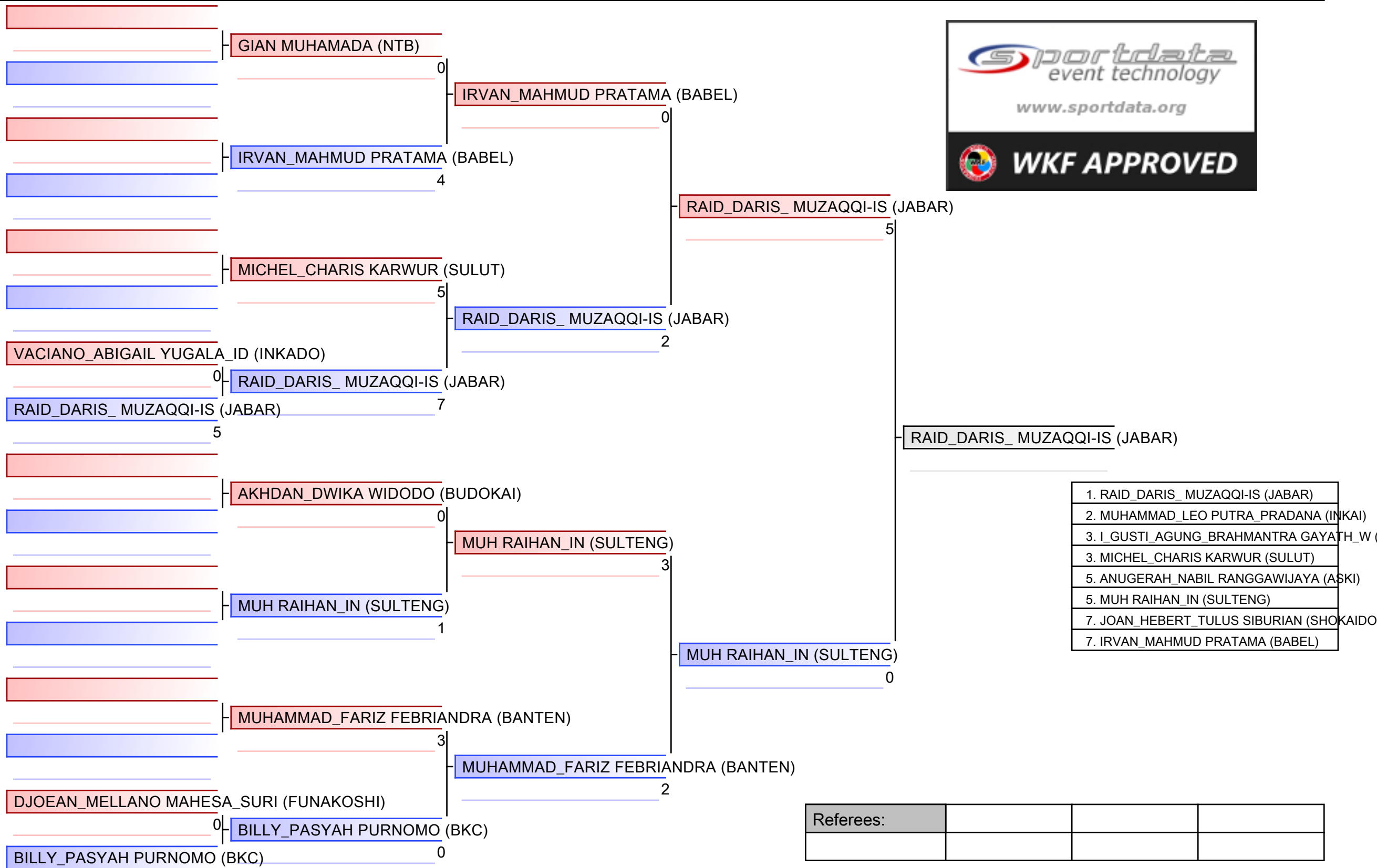

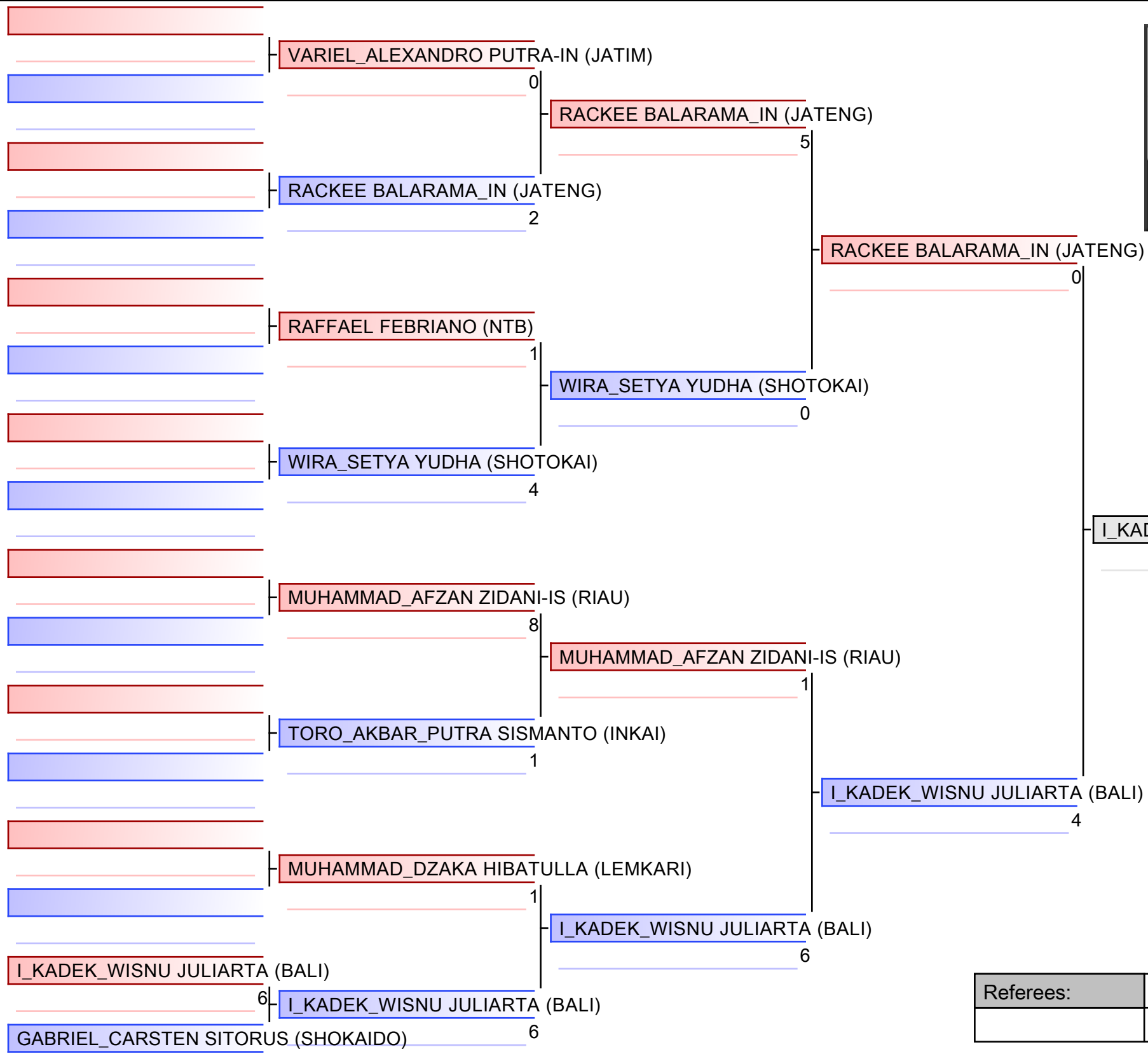

- | |
|---|
| 1. I_KADEK_WISNU JULIARTA (BALI) |
| 2. MUHAMAD_ADE WIJAYA-IN (JABAR) |
| 3. RACKEE BALARAMA_IN (JATENG) |
| 3. WINTAMA_DIMAS FIQIH-KI (LAMPUNG) |
| 5. MUHAMMAD_AFZAN ZIDANI-IS (RIAU) |
| 5. EXELINDO GRANDIS_PELUPESSY_IN (SULTEN) |
| 7. MUHAMMAD_DZAKA HIBATULLA (LEMKARI) |
| 7. MUHAMMAD_ATHAILLAH AL_CHARIM (GOJUK) |

Referees:			

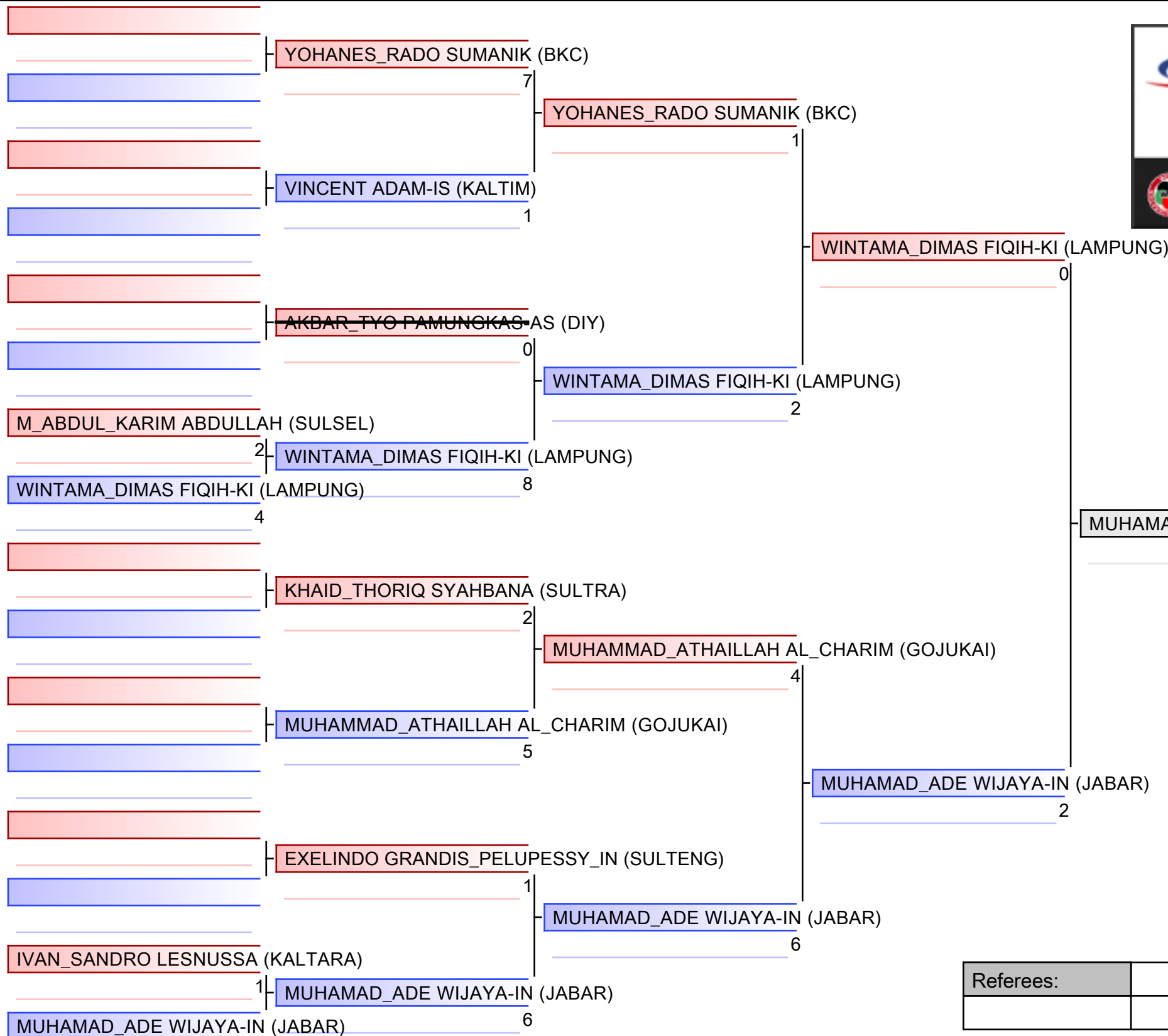

- | |
|--|
| 1. I_KADEK_WISNU JULIARTA (BALI) |
| 2. MUHAMAD_ADE WIJAYA-IN (JABAR) |
| 3. RACKEE BALARAMA_IN (JATENG) |
| 3. WINTAMA_DIMAS FIQIH-KI (LAMPUNG) |
| 5. MUHAMMAD_AFZAN ZIDANI-IS (RIAU) |
| 5. EXELINDO GRANDIS_PELUPESSY_IN (SULTENG) |
| 7. MUHAMMAD_DZAKA HIBATULLA (LEMKARI) |
| 7. MUHAMMAD_ATHAILLAH AL_CHARIM (GOJUKAI) |

Referees:			

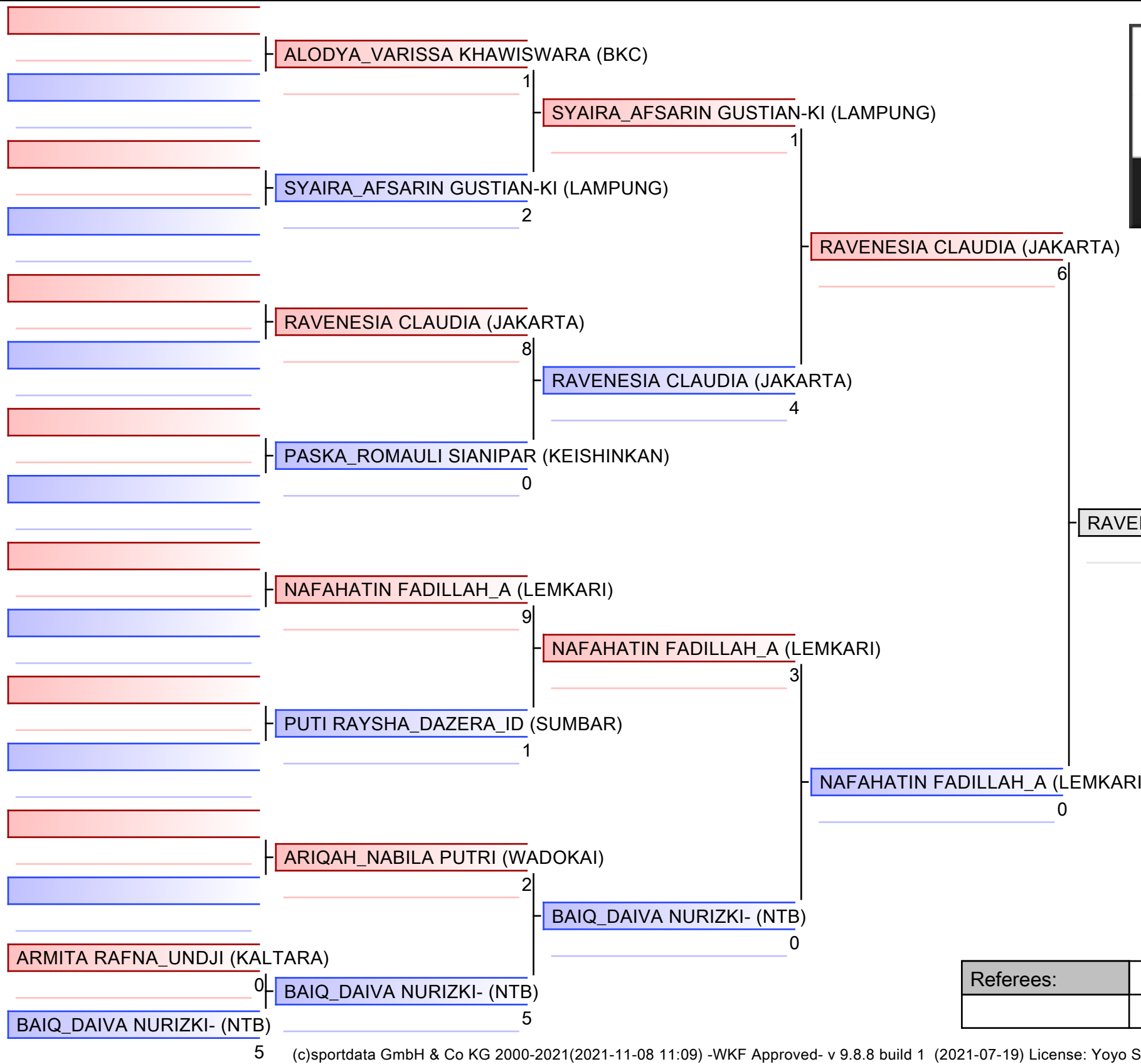

- | |
|--|
| 1. ALMAHYRA_TIARA SANDI (INKANAS) |
| 2. RAVENESIA CLAUDIA (JAKARTA) |
| 3. SYAIRA_AFSARIN GUSTIAN-KI (LAMPUNG) |
| 3. GRAISELLA_HELENA TARANDUNG (SULUT) |
| 5. NAFAHATIN FADILLAH_A (LEMKARI) |
| 5. SALMA AULIA_ (INKAI) |
| 7. PASKA_ROMAULI SIANIPAR (KEISHINKAN) |
| 7. NABILA PUSPA_WK (JATENG) |

Referees:			

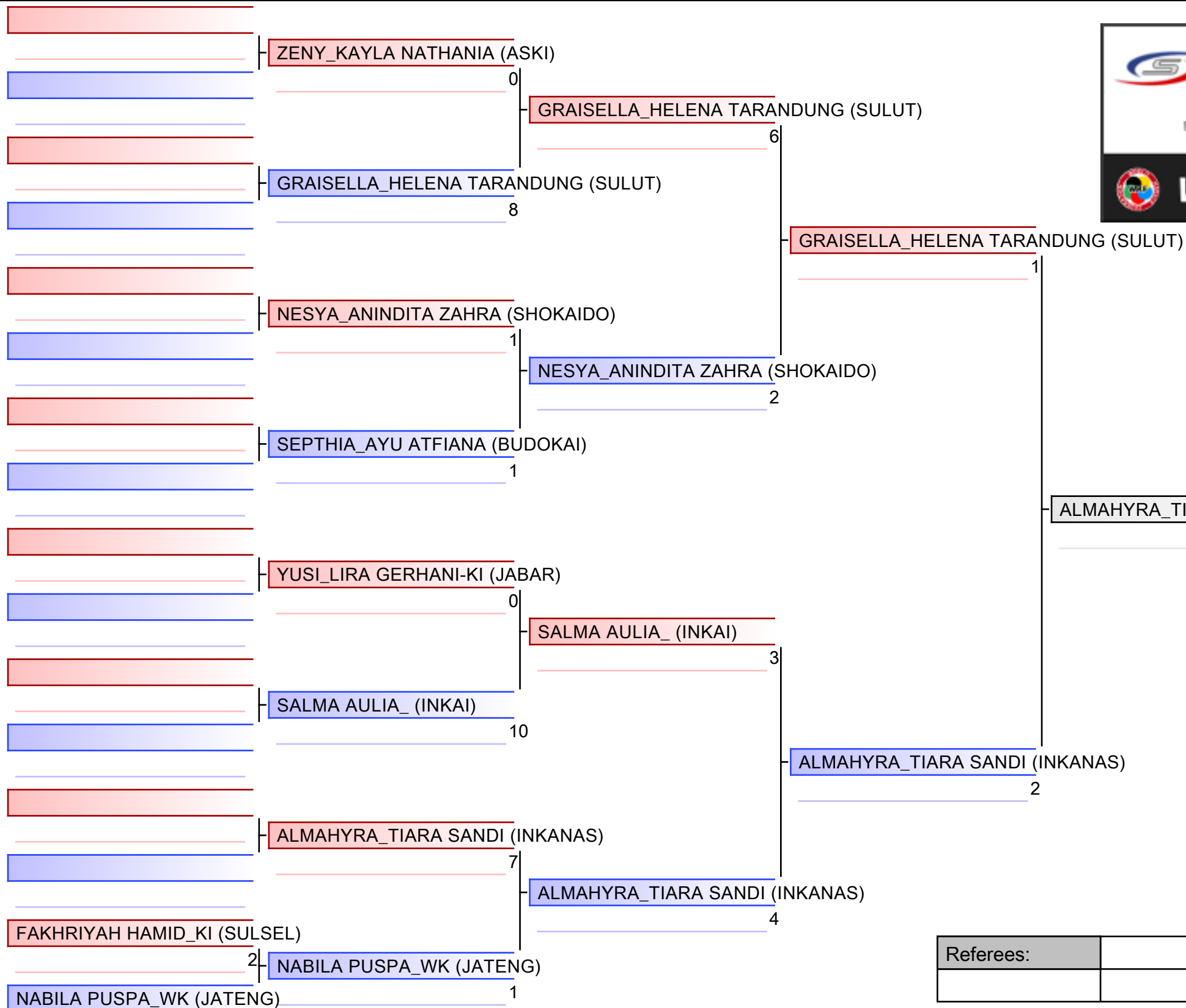

- | |
|--|
| 1. ALMAHYRA_TIARA SANDI (INKANAS) |
| 2. RAVENESIA CLAUDIA (JAKARTA) |
| 3. SYAIRA_AFSARIN GUSTIAN-KI (LAMPUNG) |
| 3. GRAISELLA_HELENA TARANDUNG (SULUT) |
| 5. NAFAHATIN FADILLAH_A (LEMKARI) |
| 5. SALMA AULIA_ (INKAI) |
| 7. PASKA_ROMAULI SIANIPAR (KEISHINKAN) |
| 7. NABILA PUSPA_WK (JATENG) |

Referees:			

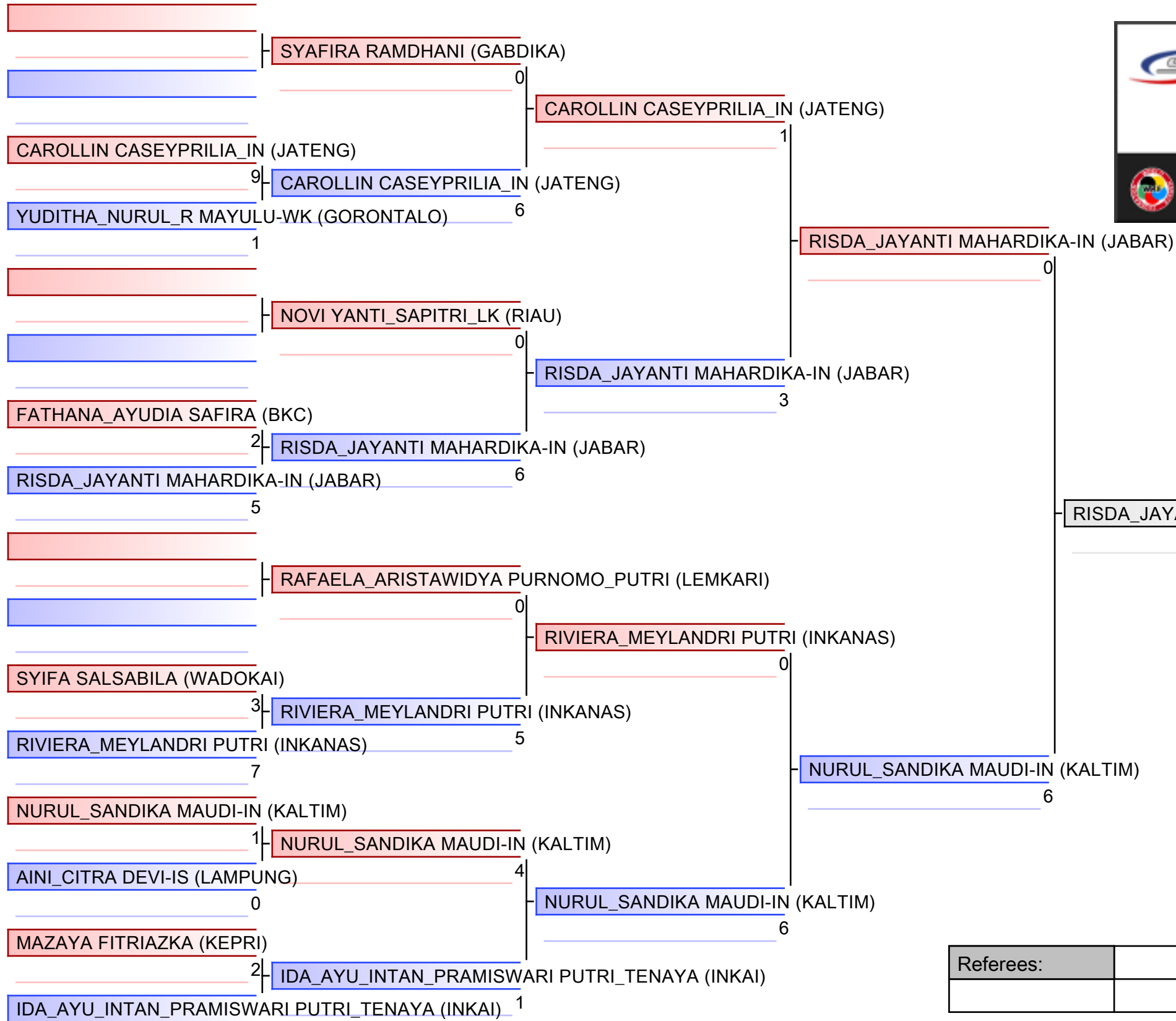

- | |
|--|
| 1. RISDA_JAYANTI MAHARDIKA-IN (JABAR) |
| 2. KEISHA AURELYA (ASKI) |
| 3. CAROLLIN CASEYPRILIA_IN (JATENG) |
| 3. PRIEL_RENATA_YOSINA HIDOM (INKADO) |
| 5. NURUL_SANDIKA MAUDI-IN (KALTIM) |
| 5. IDA_AYU_MIRAH PRAMISWARI_PUTRI_TENAYA |
| 7. NOVI YANTI_SAPITRI_LK (RIAU) |
| 7. NAURAH RAUDHATUL_JANNAH_WK (SUMSEL) |

Referees:			

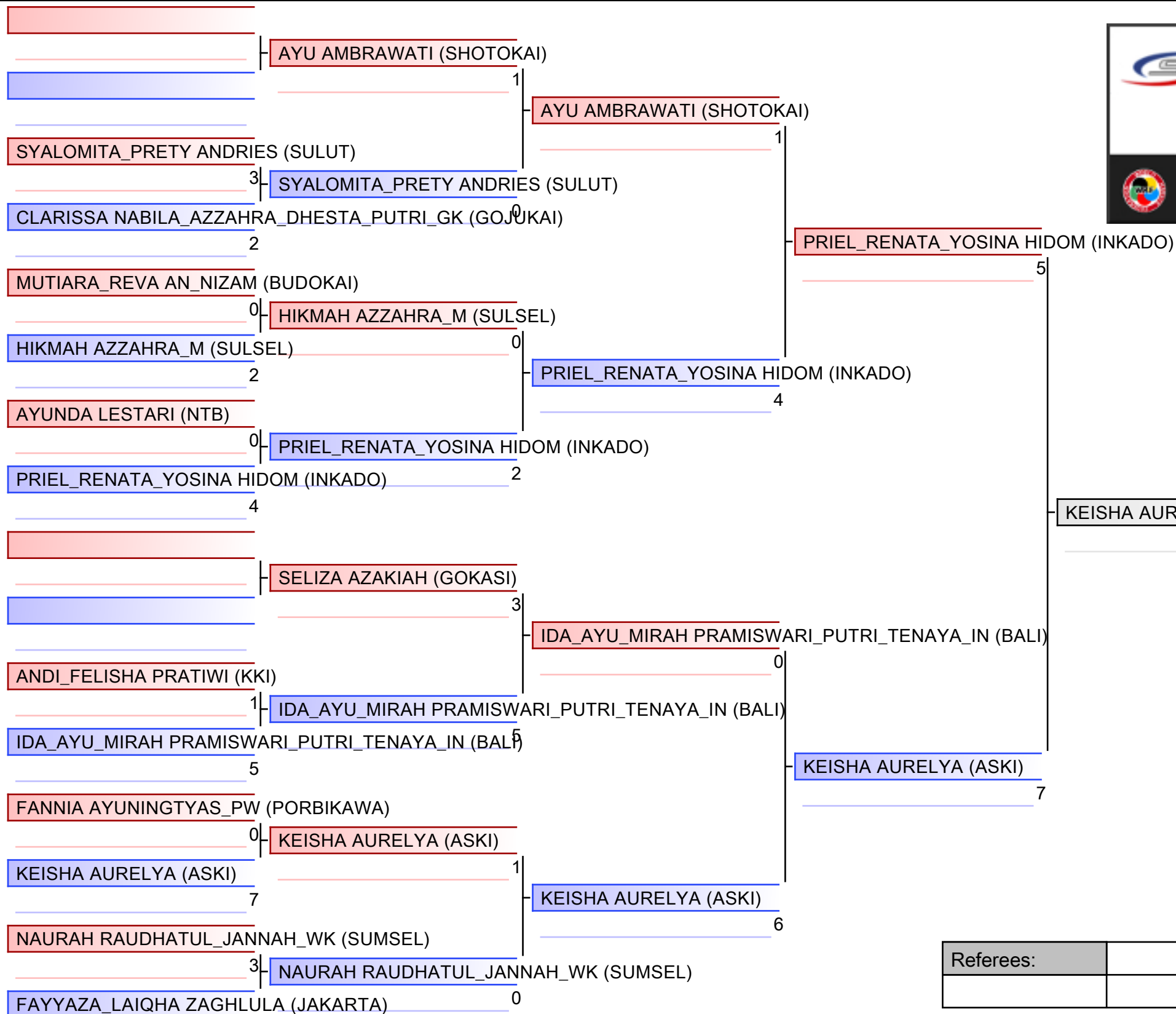

- | |
|--|
| 1. RISDA_JAYANTI MAHARDIKA-IN (JABAR) |
| 2. KEISHA AURELYA (ASKI) |
| 3. CAROLLIN CASEYPRILIA_IN (JATENG) |
| 3. PRIEL_RENATA_YOSINA HIDOM (INKADO) |
| 5. NURUL_SANDIKA MAUDI-IN (KALTIM) |
| 5. IDA_AYU_MIRAH PRAMISWARI_PUTRI_TENAYA_IN (BALI) |
| 7. NOVI YANTI_SAPITRI_LK (RIAU) |
| 7. NAURAH RAUDHATUL_JANNAH_WK (SUMSEL) |

Referees:			

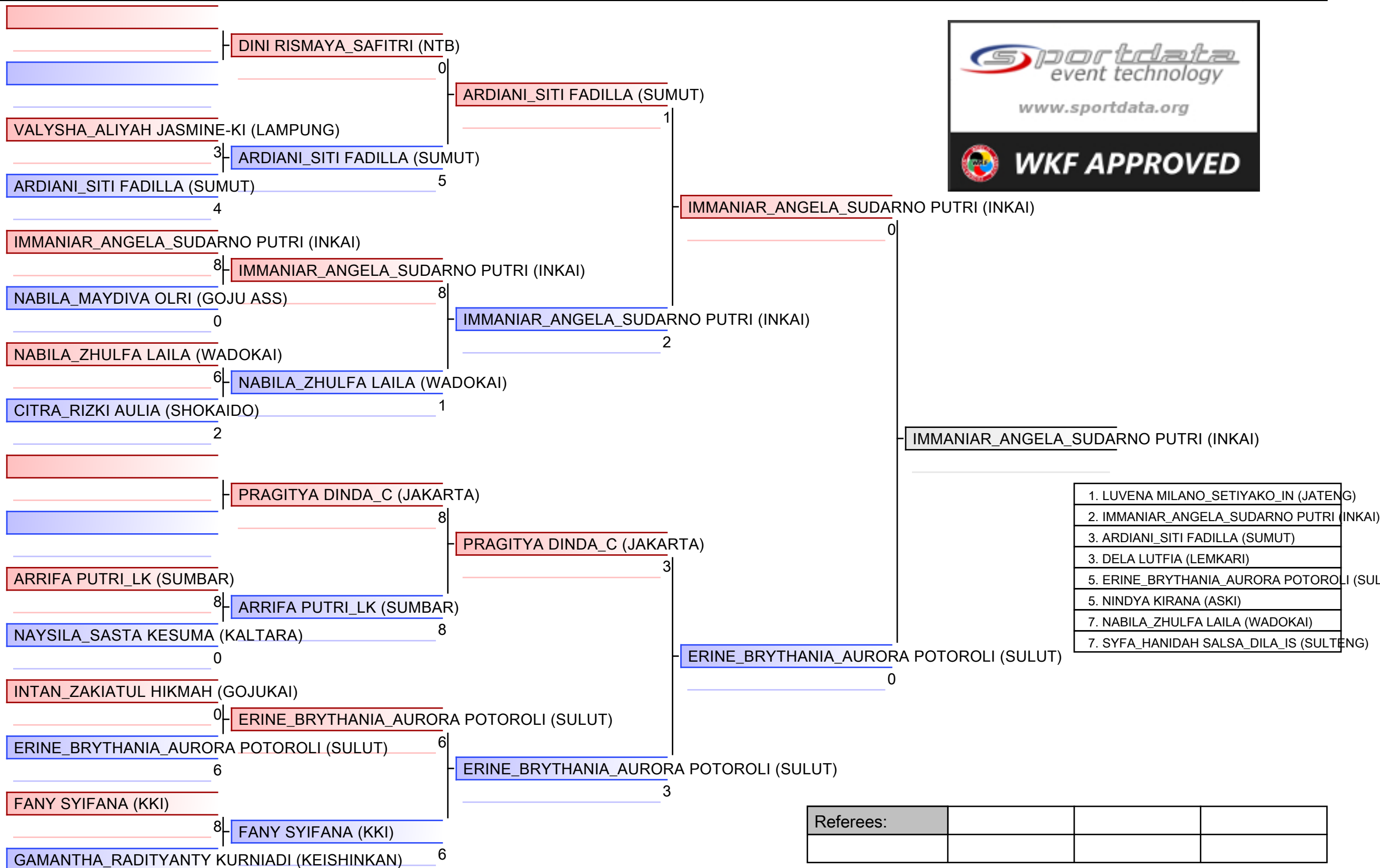

1. LUVENA MILANO_SETIYAKO_IN (JATENG)
2. IMMANIAR_ANGELA_SUDARNO PUTRI (INKAI)
3. ARDIANI_SITI FADILLA (SUMUT)
3. DELA LUTFIA (LEMKARI)
5. ERINE_BRYTHANIA_AURORA POTOROLI (SULUT)
5. NINDYA KIRANA (ASKI)
7. NABILA_ZHULFA LAILA (WADOKAI)
7. SYFA_HANIDAH SALSA_DILA_IS (SULTENG)

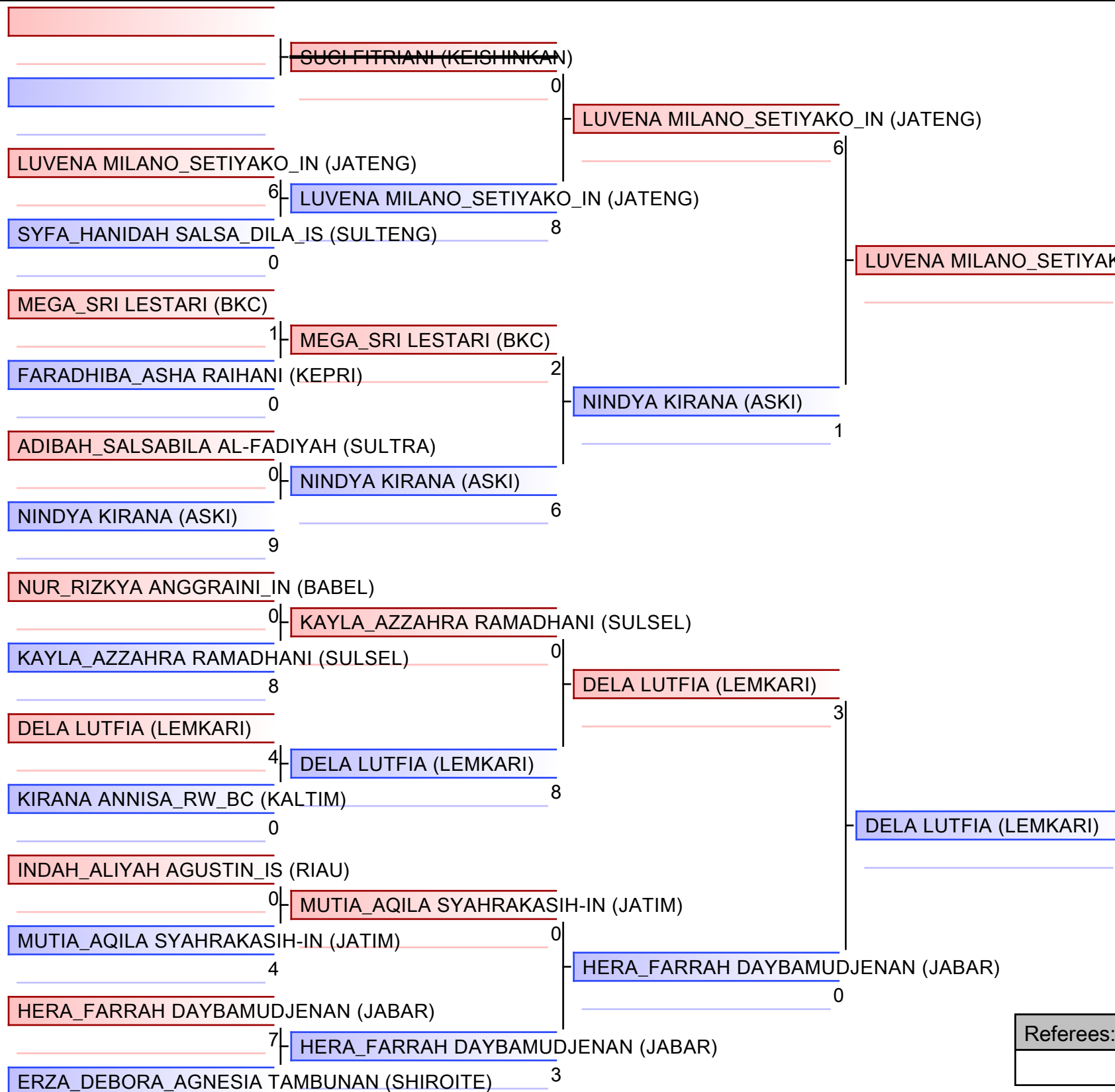

- | |
|--|
| 1. LUVENA MILANO_SETIYAKO_IN (JATENG) |
| 2. IMMANIAR_ANGELA_SUDARNO PUTRI (INKAI) |
| 3. ARDIANI_SITI FADILLA (SUMUT) |
| 3. DELA LUTFIA (LEMKARI) |
| 5. ERINE_BRYTHANIA_AURORA POTOROLI (SUL) |
| 5. NINDYA KIRANA (ASKI) |
| 7. NABILA_ZHULFA LAILA (WADOKAI) |
| 7. SYFA_HANIDAH SALSA_DILA_IS (SULTENG) |

Referees:			

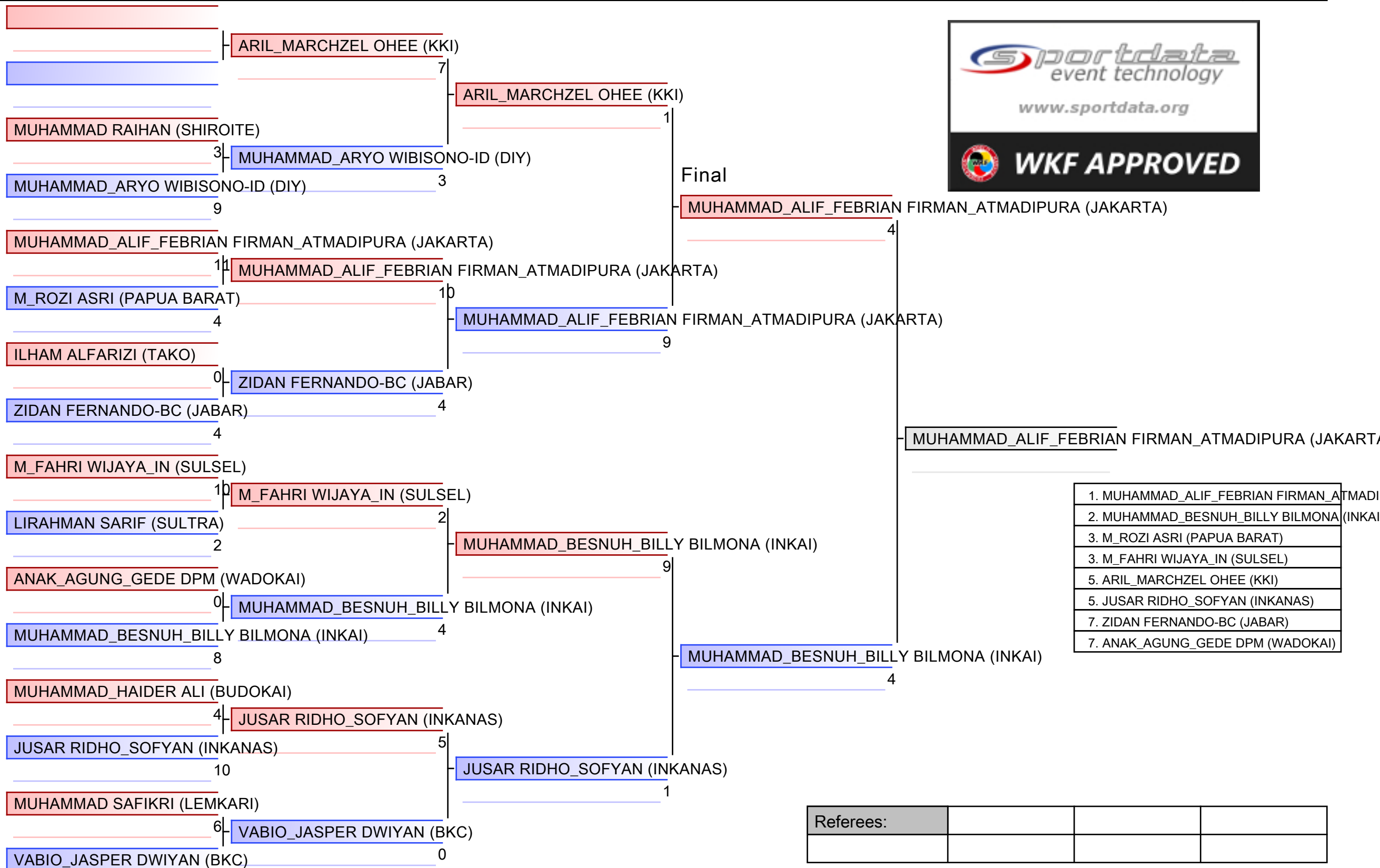

- | |
|--|
| 1. MUHAMMAD_ALIF_FEBRIAN FIRMAN_ATMADIPURA (JAKARTA) |
| 2. MUHAMMAD_BESNUH_BILLY BILMONA (INKAI) |
| 3. M_ROZI ASRI (PAPUA BARAT) |
| 3. M_FAHRI WIJAYA_IN (SULSEL) |
| 5. ARIL_MARCHZEL OHEE (KKI) |
| 5. JUSAR RIDHO_SOFYAN (INKANAS) |
| 7. ZIDAN FERNANDO-BC (JABAR) |
| 7. ANAK_AGUNG_GEDE DPM (WADOKAI) |

Referees:			

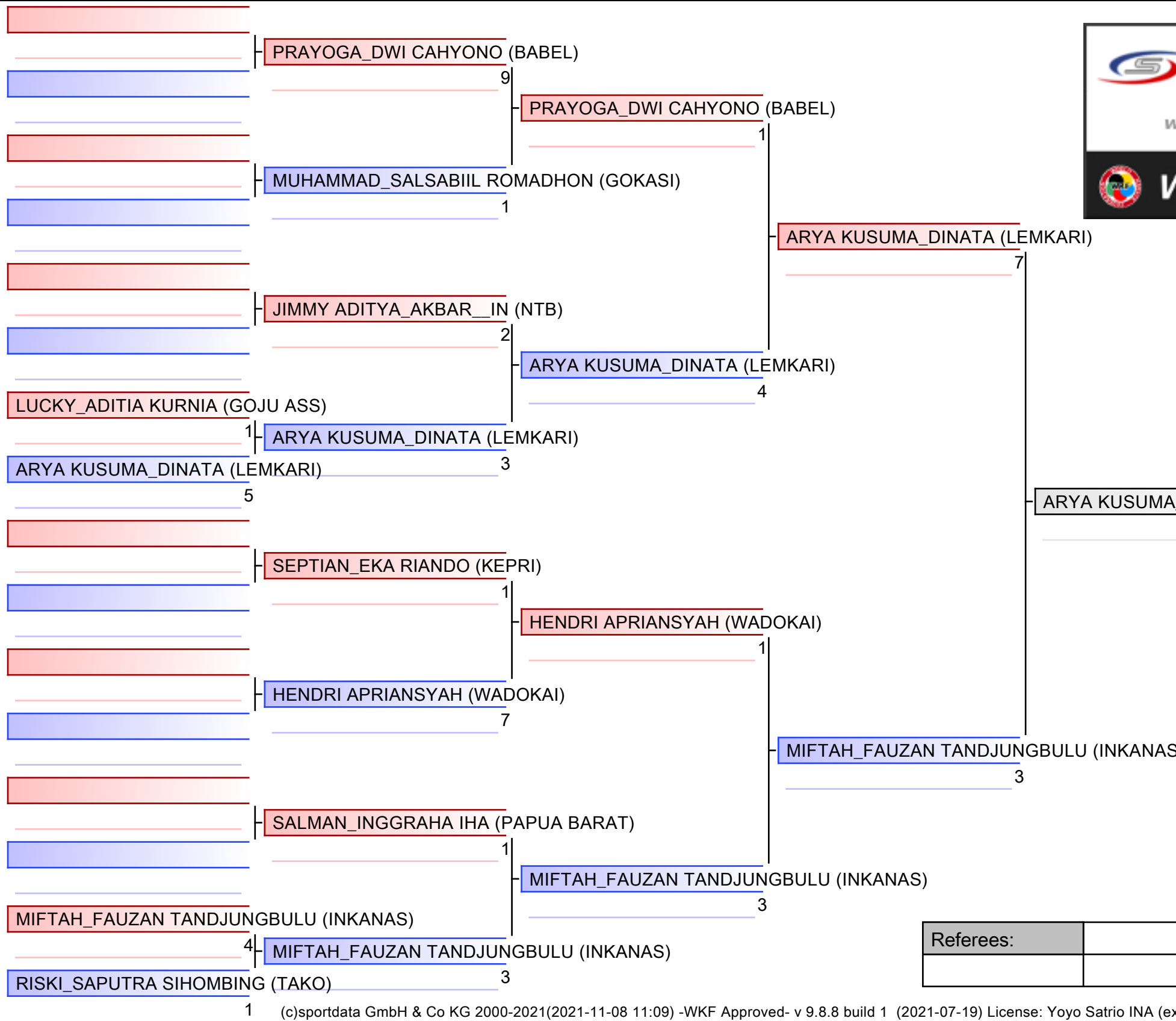

- | |
|---|
| 1. RANDEL FREDERICKY_PANTOUW_IS (JATIM) |
| 2. ARYA KUSUMA_DINATA (LEMKARI) |
| 3. PRAYOGA_DWI CAHYONO (BABEL) |
| 3. RINALDY RAMADIA (JAKARTA) |
| 5. MIFTAH_FAUZAN TANDJUNGBULU (INKANAS) |
| 5. ILHAM_YADI SYAM (BKC) |
| 7. JIMMY ADITYA_AKBAR_IN (NTB) |
| 7. ANDI_RAFLI RANDI (INKADO) |

Referees:			

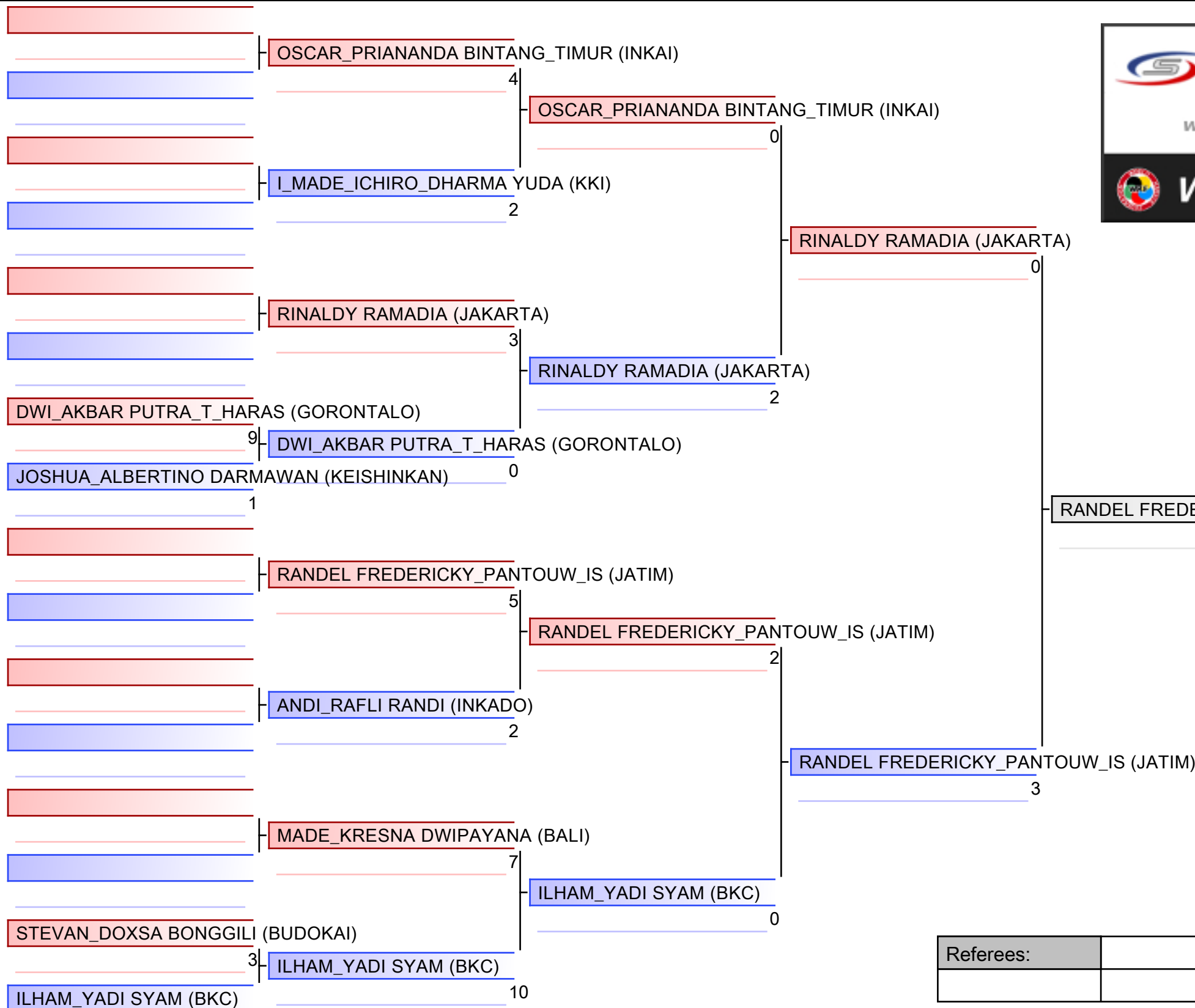

- | |
|---|
| 1. RANDEL FREDERICKY_PANTOUW_IS (JATIM) |
| 2. ARYA KUSUMA_DINATA (LEMKARI) |
| 3. PRAYOGA_DWI CAHYONO (BABEL) |
| 3. RINALDY RAMADIA (JAKARTA) |
| 5. MIFTAH_FAUZAN TANDJUNGBULU (INKANAS) |
| 5. ILHAM_YADI SYAM (BKC) |
| 7. JIMMY ADITYA_AKBAR_IN (NTB) |
| 7. ANDI_RAFLI RANDI (INKADO) |

Referees:			

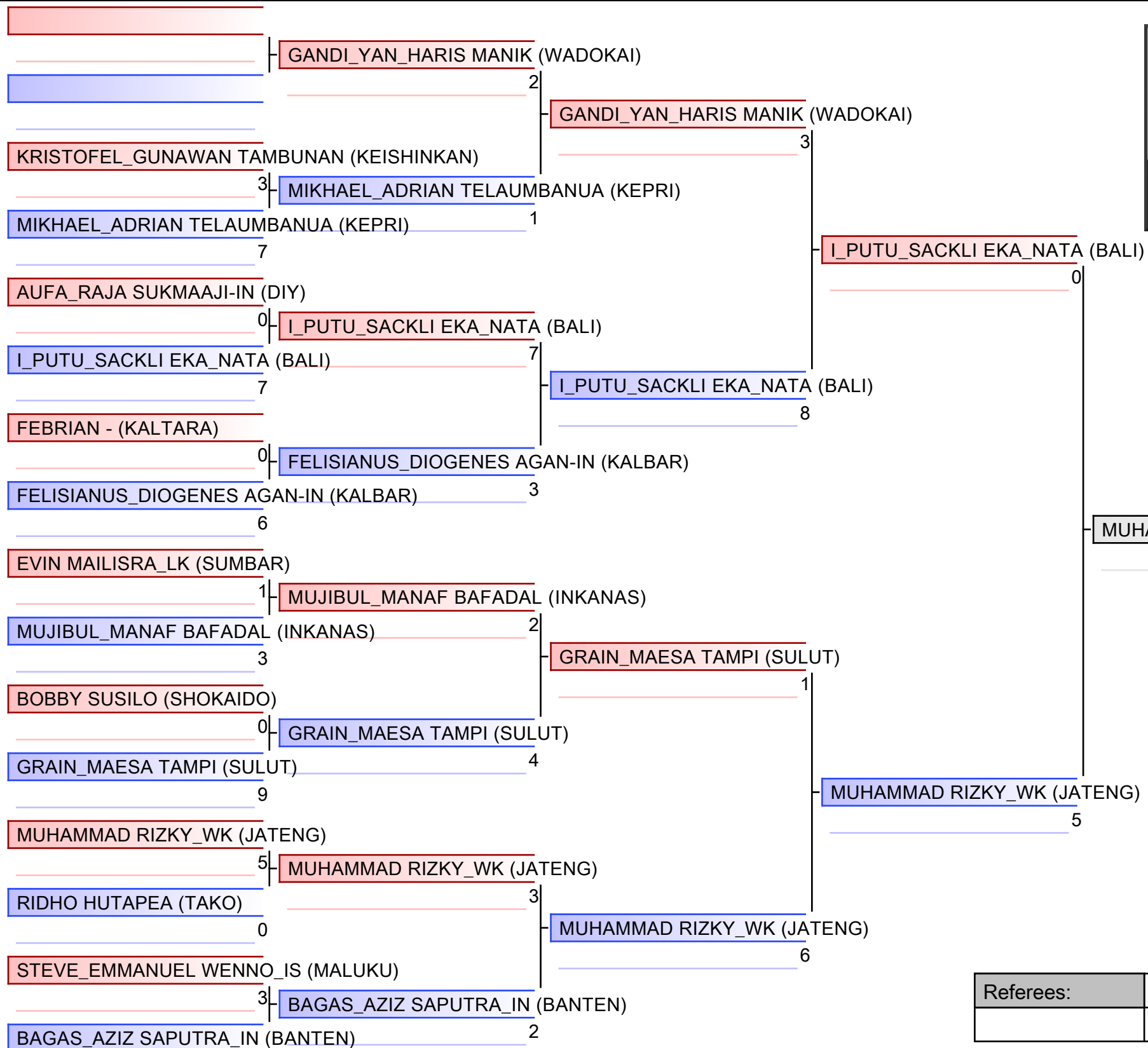

MUHAMMAD RIZKY_WK (JATENG)

- | |
|-------------------------------------|
| 1. MUHAMMAD RIZKY_WK (JATENG) |
| 2. MARSUGIANSYAH ZULFIKAR (JAKARTA) |
| 3. FRANSISCUS_FINA SAUNOA (INKAI) |
| 3. GRAIN_MAESA TAMPI (SULUT) |
| 5. M_ARDHIAT SYAM (SULSEL) |
| 5. I_PUTU_SACKLI EKA_NATA (BALI) |
| 7. MUHAMMAD_FAJRUL MANA (NTB) |
| 7. RIDHO HUTAPEA (TAKO) |

Referees:			

RAYHAN FAKHIRA_NURUL_H_IN (BABEL)

0 | M_ARDHIAT SYAM (SULSEL)

M_ARDHIAT SYAM (SULSEL) | 5

1 |

SUDARMAN - (INKADO)

1 | SUDARMAN - (INKADO)

JOE HARLEN_PURBA (SHIROITE) | 0

4 |

ANTHONY_PARAMADINA SEDA (BKC)

0 | MARSUGIANSYAH ZULFIKAR (JAKARTA)

MARSUGIANSYAH ZULFIKAR (JAKARTA) | 6

7 |

MUHAMMAD_FAJRUL MANA (NTB)

7 | MUHAMMAD_FAJRUL MANA (NTB)

GERALD FREDERICKO_PANTAOUW_IS (JATIM) | 2

2 |

MUHAMMAD_YUSUF_BINTANG SUSANTO-IN (JABAR)

8 | MUHAMMAD_YUSUF_BINTANG SUSANTO-IN (JABAR)

ADITYA ABIMANYU_IN (SULTENG) | 4

3 |

FRANSISCUS_FINA SAUNOA (INKAI)

6 | FRANSISCUS_FINA SAUNOA (INKAI)

LEONARDO ANDREAS_B (ASKI) | 8

0 |

ALBERT_RYANSAWA CALY_TOREY (GOJU ASS)

0 | AFDIL KHOLID (GOJUKAI)

AFDIL KHOLID (GOJUKAI) | 1

8 |

M_AIDIL FEBRI_KS (SUMUT)

7 | M_AIDIL FEBRI_KS (SUMUT)

M NAUFAL_RAIHAN (LEMKARI) | 9

1 |

M_ARDHIAT SYAM (SULSEL)

0 |

MARSUGIANSYAH ZULFIKAR (JAKARTA)

3 |

MARSUGIANSYAH ZULFIKAR (JAKARTA)

1 |

MARSUGIANSYAH ZULFIKAR (JAKARTA)

6 |

MARSUGIANSYAH ZULFIKAR (JAKARTA)

1 |

MARSUGIANSYAH ZULFIKAR (JAKARTA)

3 |

MARSUGIANSYAH ZULFIKAR (JAKARTA)

8 |

MUHAMMAD_YUSUF_BINTANG SUSANTO-IN (JABAR)

4 |

FRANSISCUS_FINA SAUNOA (INKAI)

6 |

FRANSISCUS_FINA SAUNOA (INKAI)

1 |

FRANSISCUS_FINA SAUNOA (INKAI)

6 |

M_AIDIL FEBRI_KS (SUMUT)

3 |

M_AIDIL FEBRI_KS (SUMUT)

9 |

M_AIDIL FEBRI_KS (SUMUT)

1 |



MARSUGIANSYAH ZULFIKAR (JAKARTA)

- | |
|-------------------------------------|
| 1. MUHAMMAD RIZKY_WK (JATENG) |
| 2. MARSUGIANSYAH ZULFIKAR (JAKARTA) |
| 3. FRANSISCUS_FINA SAUNOA (INKAI) |
| 3. GRAIN_MAESA TAMPI (SULUT) |
| 5. M_ARDHIAT SYAM (SULSEL) |
| 5. I_PUTU_SACKLI EKA_NATA (BALI) |
| 7. MUHAMMAD_FAJRUL MANA (NTB) |
| 7. RIDHO HUTAPEA (TAKO) |

Referees:			

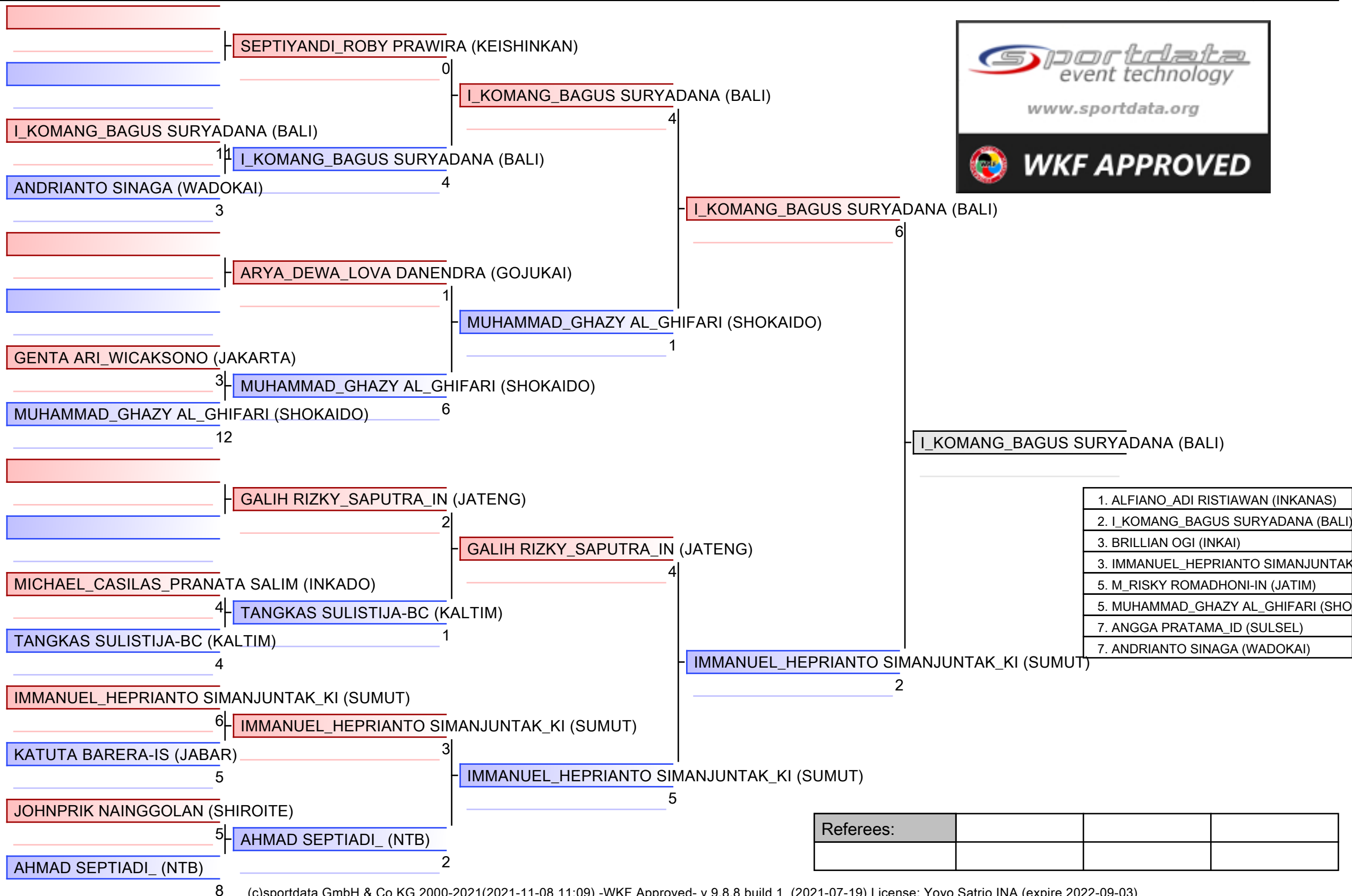

- | |
|--|
| 1. ALFIANO_ADI RISTIAWAN (INKANAS) |
| 2. I_KOMANG_BAGUS SURYADANA (BALI) |
| 3. BRILLIAN OGI (INKAI) |
| 3. IMMANUEL_HEPRIANTO SIMANJUNTAK_KI (SUMUT) |
| 5. M_RISKY ROMADHONI-IN (JATIM) |
| 5. MUHAMMAD_GHAZY AL_GHIFARI (SHOKAIDO) |
| 7. ANGGA PRATAMA_ID (SULSEL) |
| 7. ANDRIANTO SINAGA (WADOKAI) |

Referees:			

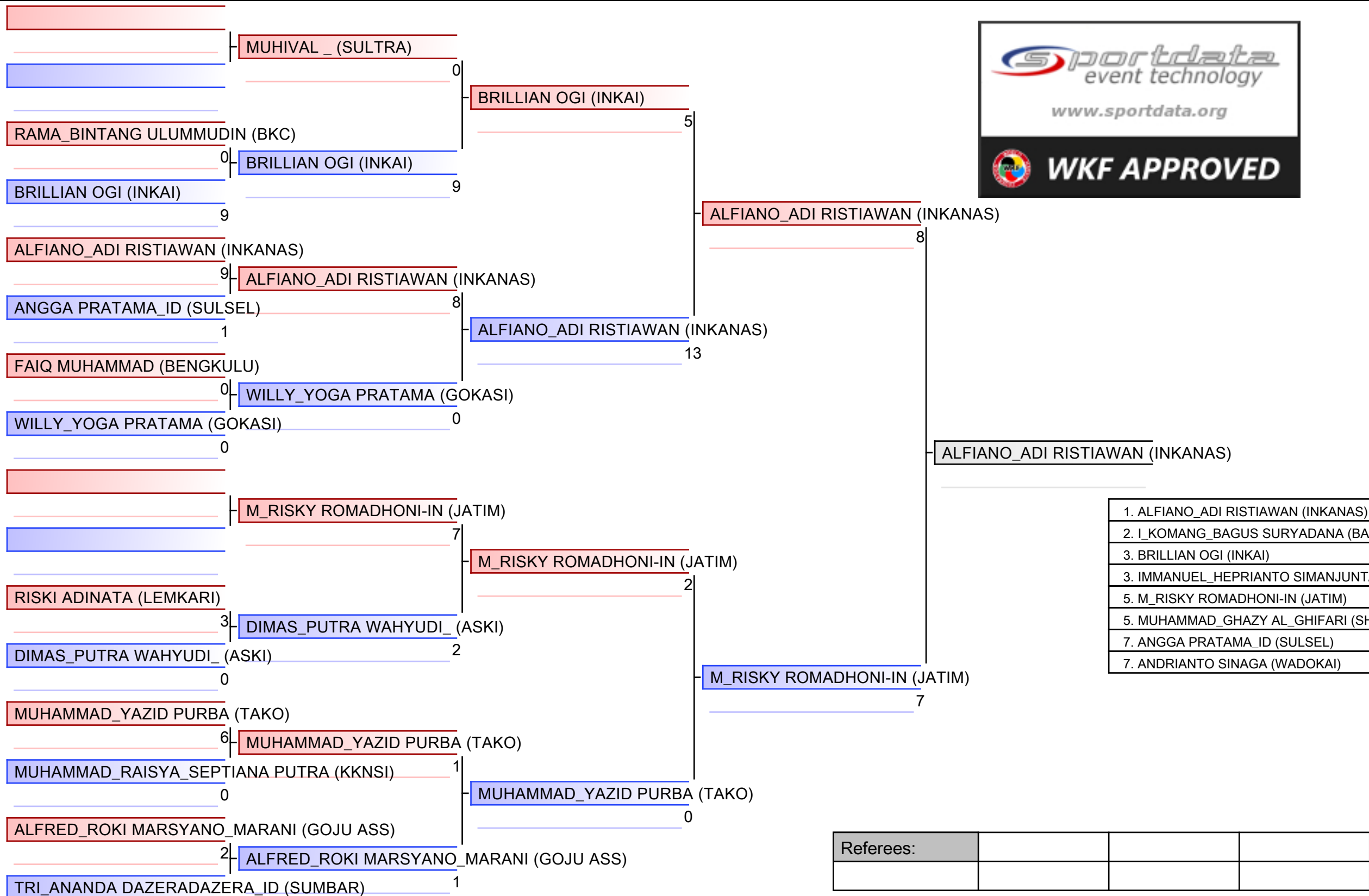

Referees:			

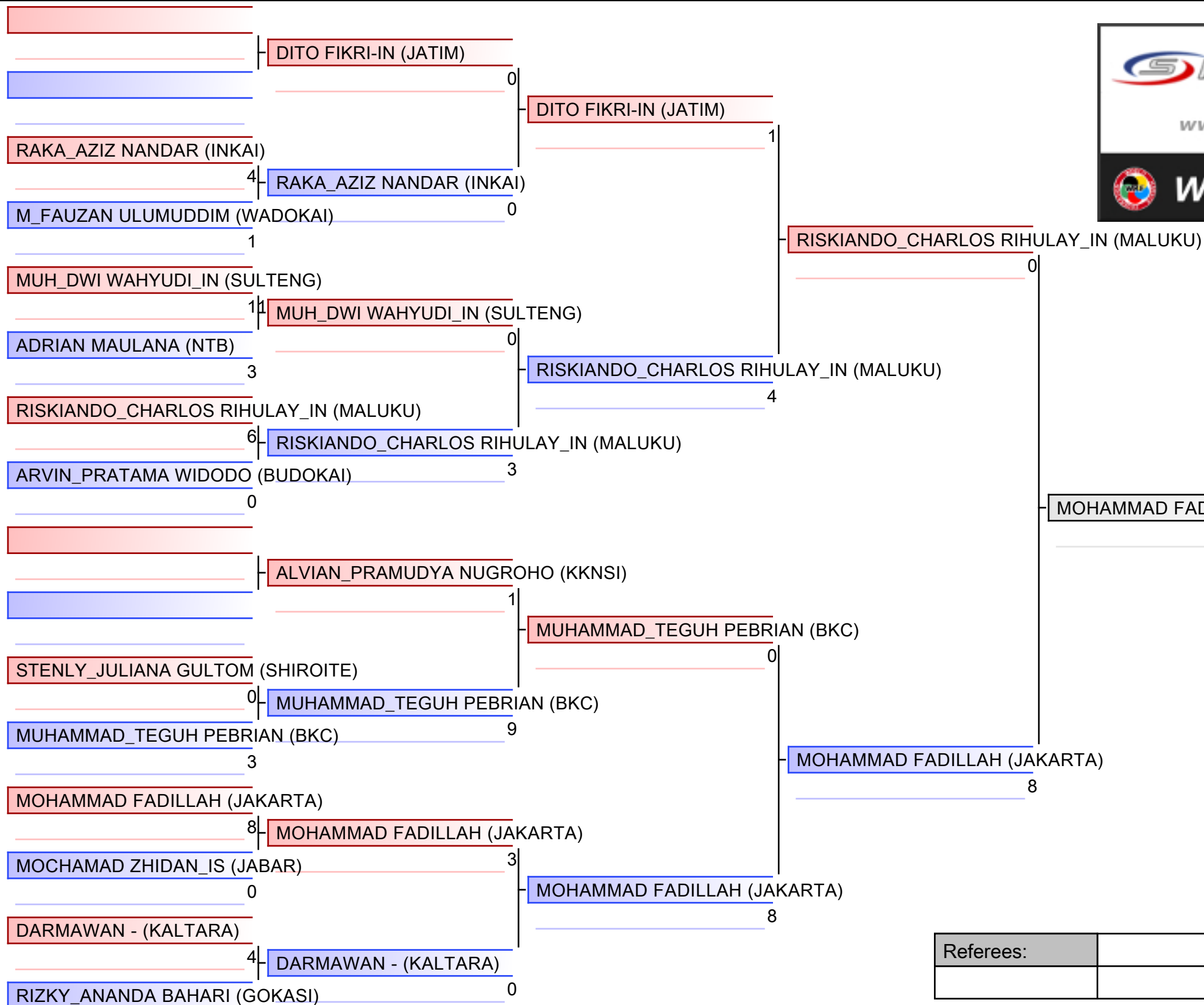

- | |
|--|
| 1. MOHAMMAD FADILLAH (JAKARTA) |
| 2. IRWANSYAH_HAFIDH LUBIS (INKANAS) |
| 3. RISKIANDO_CHARLOS RIHULAY_IN (MALUKU) |
| 3. DUSKY MUBARAQ (TAKO) |
| 5. MOCHAMAD ZHIDAN_IS (JABAR) |
| 5. I_GUSTI_PUTU NGURAH_WIDIWAN (BALI) |
| 7. MUHAMMAD_TEGUH PEBRIAN (BKC) |
| 7. WIRA_SURYA ADESAPUTRA_IN (SULSEL) |

Referees:			

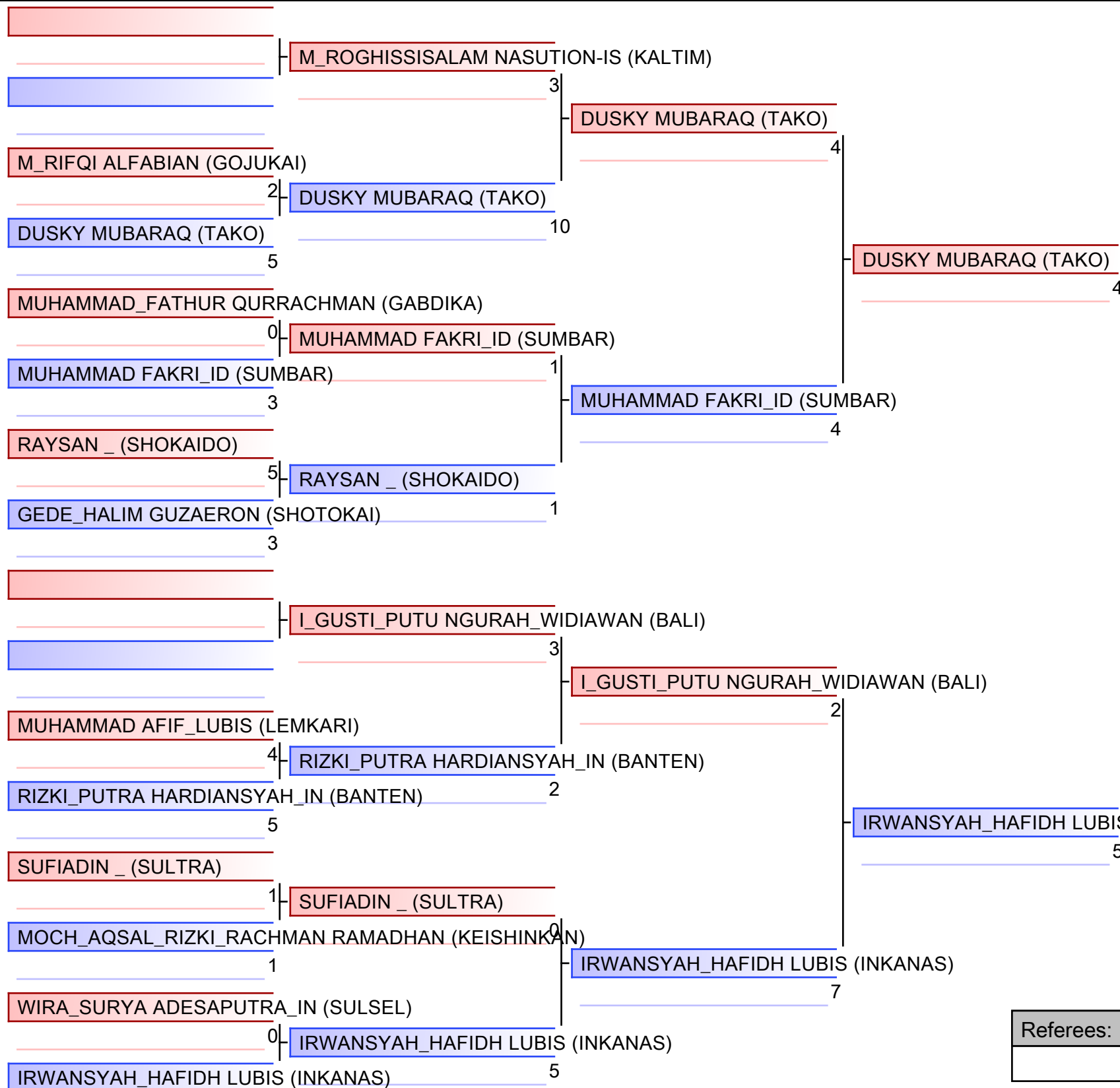

- | |
|--|
| 1. MOHAMMAD FADILLAH (JAKARTA) |
| 2. IRWANSYAH_HAFIDH LUBIS (INKANAS) |
| 3. RISKIANDO_CHARLOS RIHULAY_IN (MALUKU) |
| 3. DUSKY MUBARAQ (TAKO) |
| 5. MOCHAMAD ZHIDAN_IS (JABAR) |
| 5. I_GUSTI_PUTU NGURAH_WIDIAWAN (BALI) |
| 7. MUHAMMAD_TEGUH PEBRIAN (BKC) |
| 7. WIRA_SURYA ADESAPUTRA_IN (SULSEL) |

Referees:			

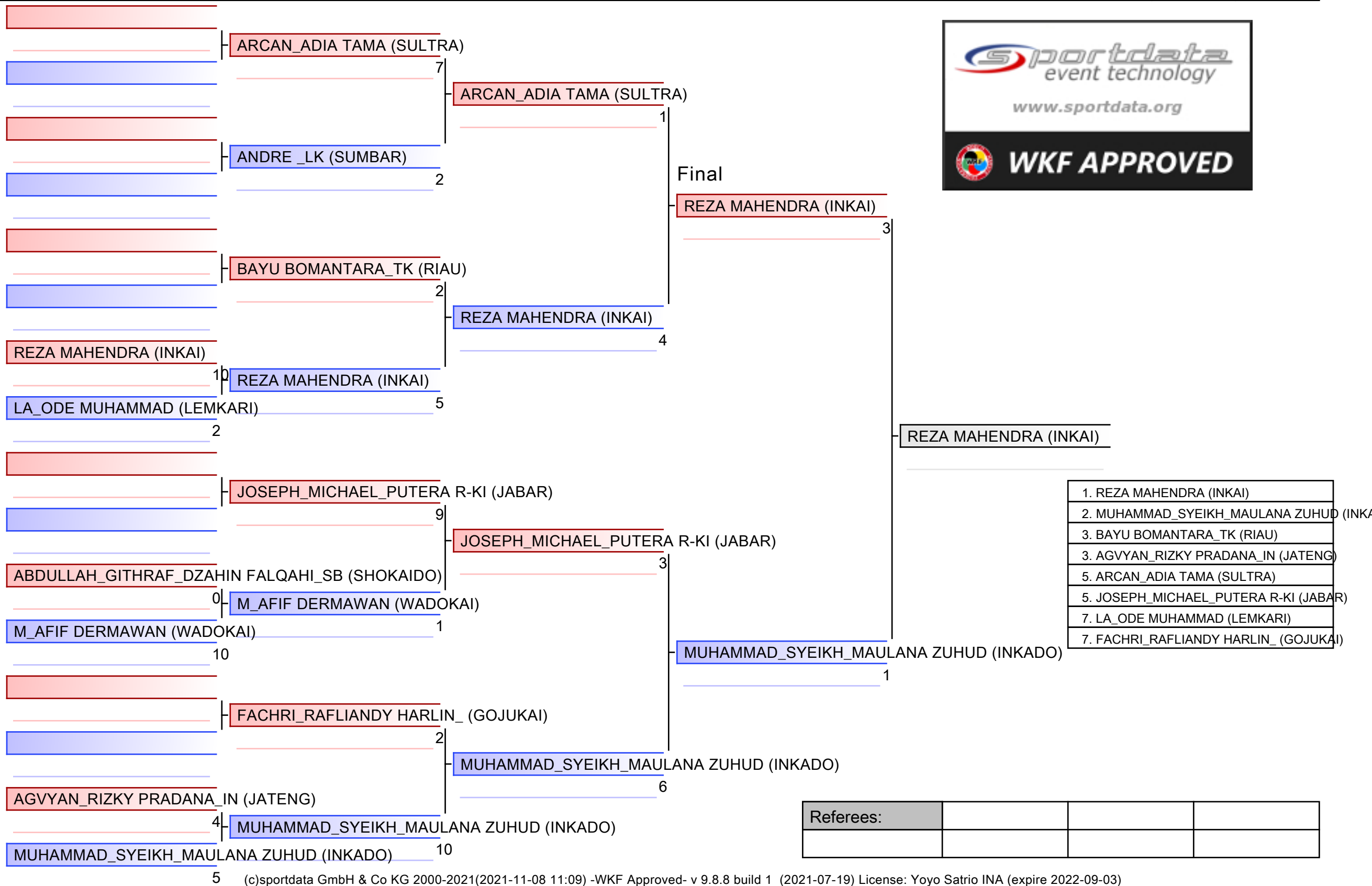

Referees:			

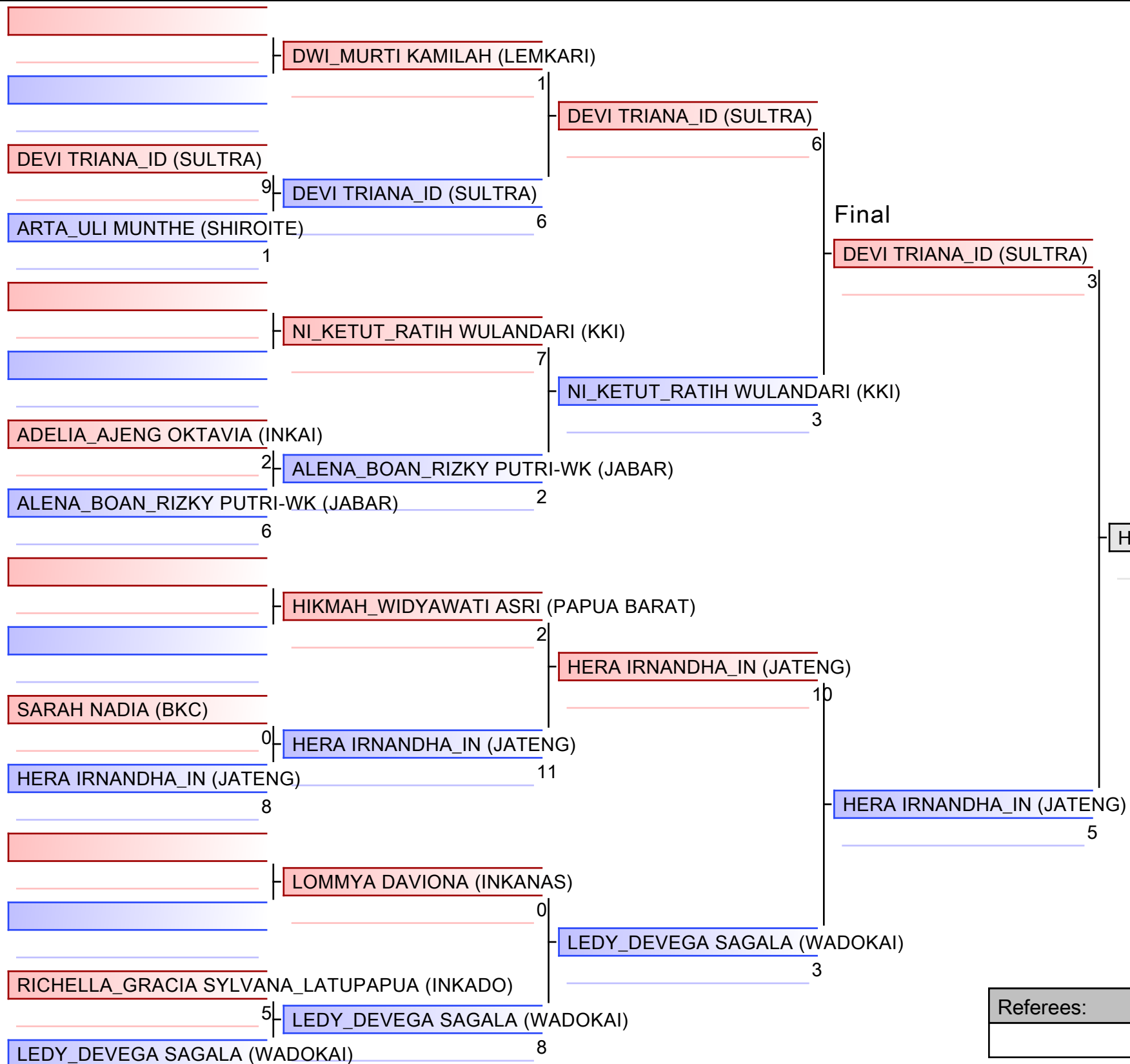

- | |
|--|
| 1. HERA IRNANDHA_IN (JATENG) |
| 2. DEVI TRIANA_ID (SULTRA) |
| 3. NI_KETUT_RATIH WULANDARI (KKI) |
| 3. LEDY_DEVEGA SAGALA (WADOKAI) |
| 5. ARTO_ULI MUNTHE (SHIROITE) |
| 5. SARAH NADIA (BKC) |
| 7. DWI_MURTI KAMILAH (LEMKARI) |
| 7. HIKMAH_WIDYAWATI ASRI (PAPUA BARAT) |

Referees:			

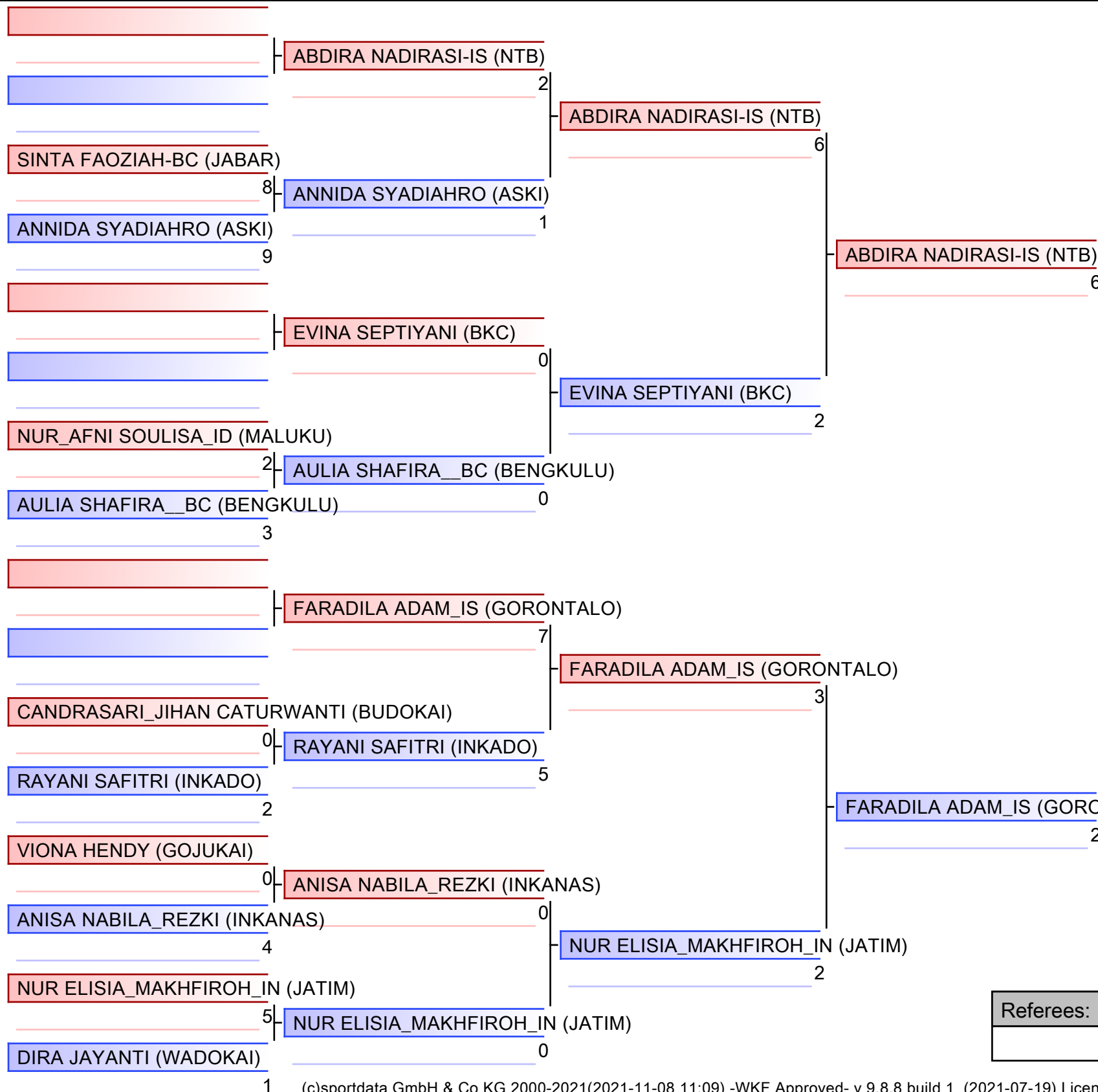

- | |
|-----------------------------------|
| 1. ANNISA_NUR ANGGRAENI (JAKARTA) |
| 2. ABDIRA NADIRASI-IS (NTB) |
| 3. FARADILA ADAM_IS (GORONTALO) |
| 3. FIQRA_DWI SASKIAH (KKI) |
| 5. ANNIDA SYADIAHRO (ASKI) |
| 5. SEKAR_DWI AYU_TYAS (LEMKARI) |
| 7. EVINA SEPTIYANI (BKC) |
| 7. MERLYANTI_BD (SULTENG) |

Referees:			

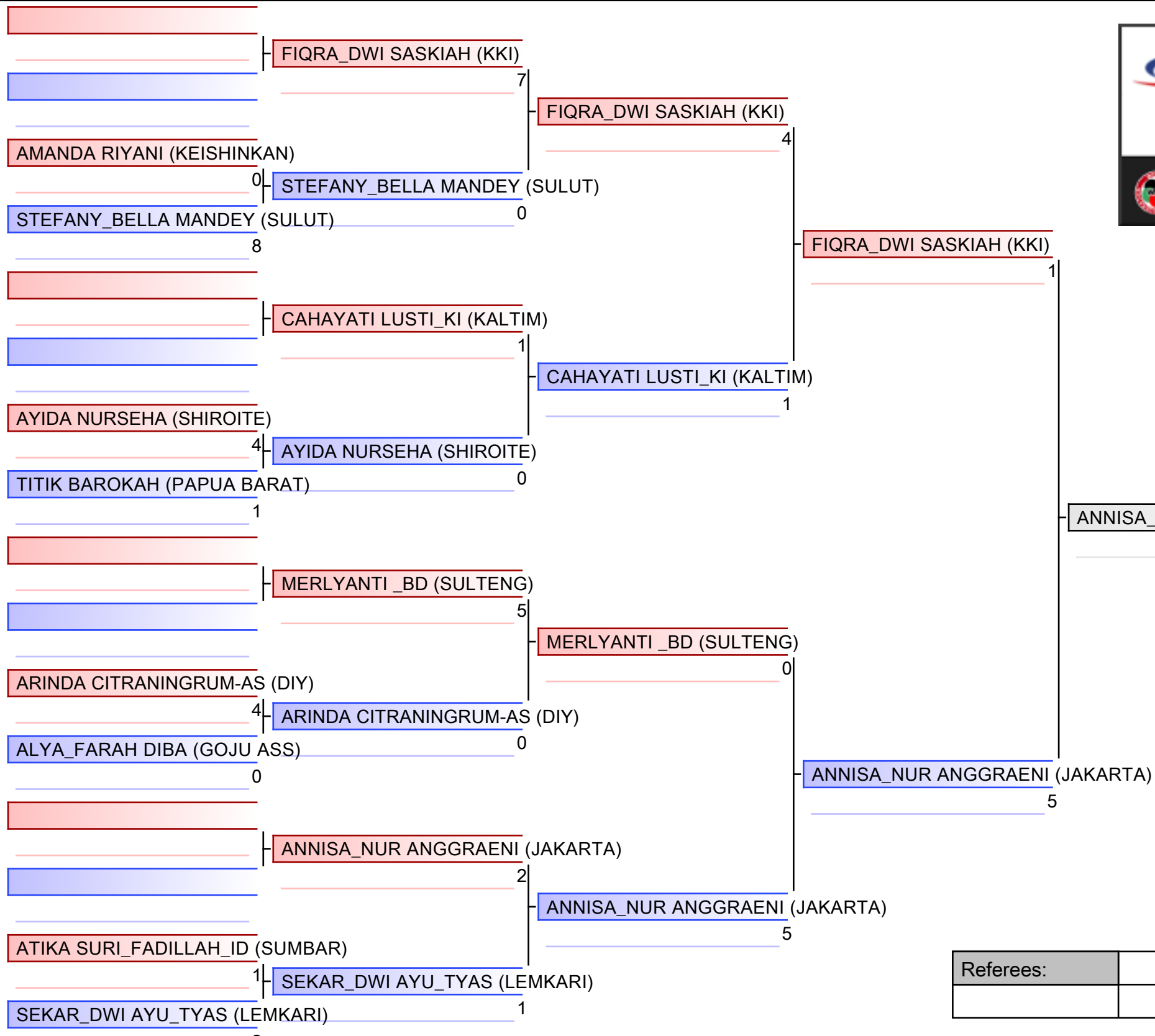

- | |
|-----------------------------------|
| 1. ANNISA_NUR ANGGRAENI (JAKARTA) |
| 2. ABDIRA NADIRASI-IS (NTB) |
| 3. FARADILA ADAM_IS (GORONTALO) |
| 3. FIQRA_DWI SASKIAH (KKI) |
| 5. ANNIDA SYADIAHRO (ASKI) |
| 5. SEKAR_DWI AYU_TYAS (LEMKARI) |
| 7. EVINA SEPTIYANI (BKC) |
| 7. MERLYANTI_BD (SULTENG) |

Referees:			

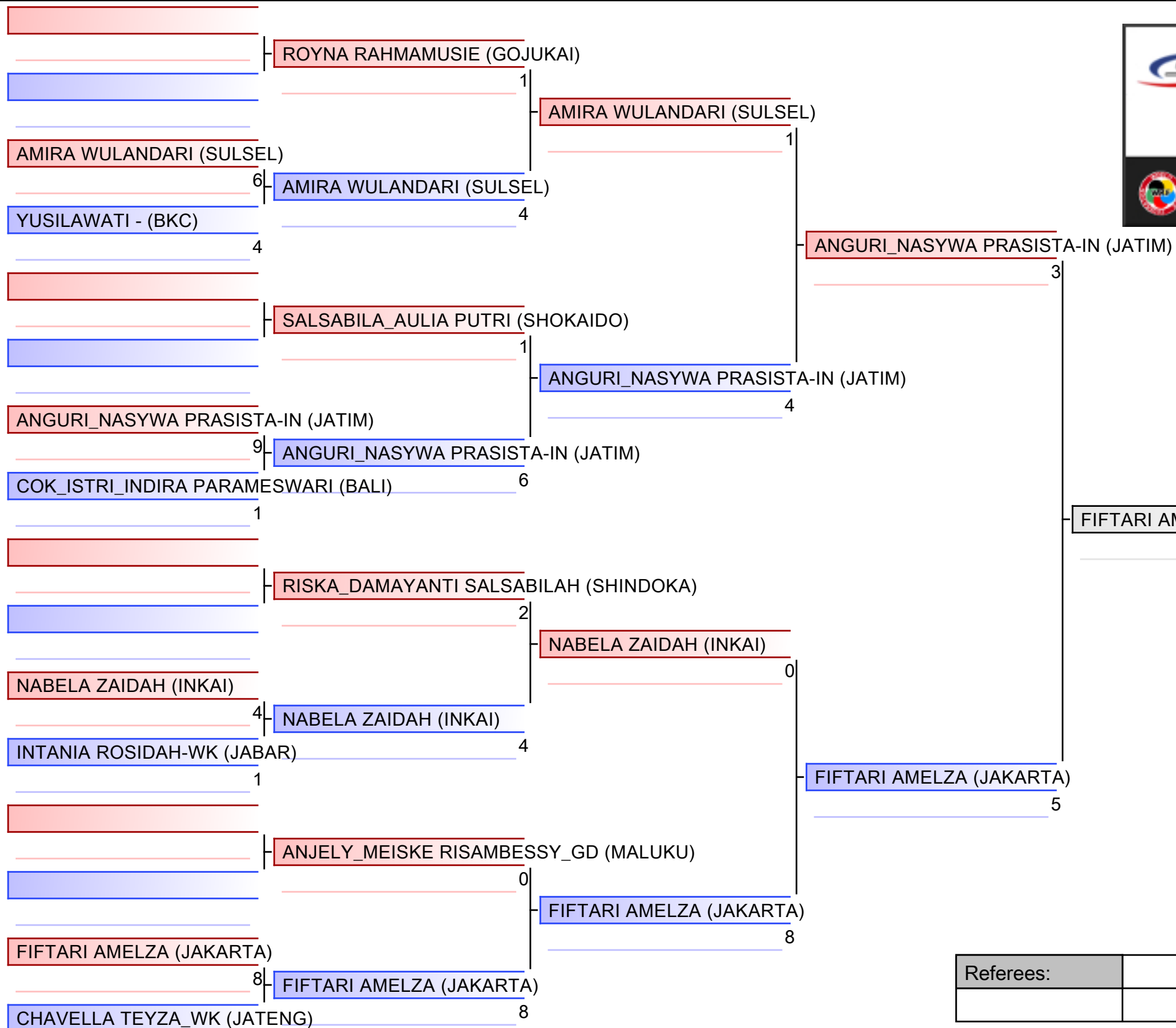

- | |
|--------------------------------------|
| 1. FIFTARI AMELZA (JAKARTA) |
| 2. ISABELLA_YOUNE MAMIKERE (INKANAS) |
| 3. ANGURI_NASYWA PRASISTA-IN (JATIM) |
| 3. SANIA - (KKI) |
| 5. NABELA ZAIDAH (INKAI) |
| 5. MARINI_SELOMITA LERAH (SULUT) |
| 7. CHAVELLA TEYZA_WK (JATENG) |
| 7. APRILIANI ELSIE-KI (KALTIM) |

Referees:			

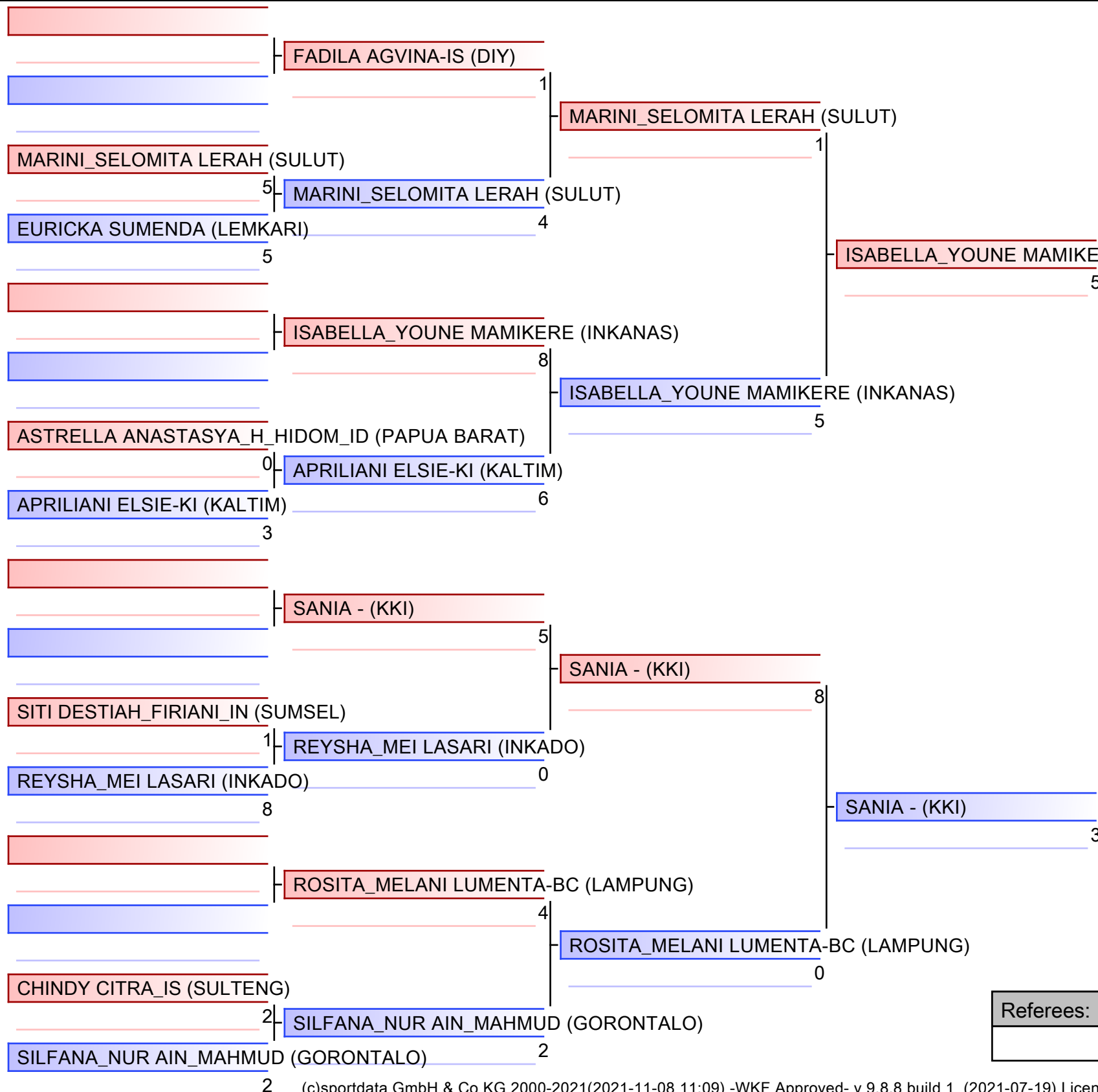

ISABELLA_YOUNE MAMIKERE (INKANAS)

- | |
|--------------------------------------|
| 1. FIFTARI AMELZA (JAKARTA) |
| 2. ISABELLA_YOUNE MAMIKERE (INKANAS) |
| 3. ANGURI_NASYWA PRASISTA-IN (JATIM) |
| 3. SANIA - (KKI) |
| 5. NABELA ZAIDAH (INKAI) |
| 5. MARINI_SELOMITA LERAH (SULUT) |
| 7. CHAVELLA TEYZA_WK (JATENG) |
| 7. APRILIANI ELSIE-KI (KALTIM) |

Referees:			

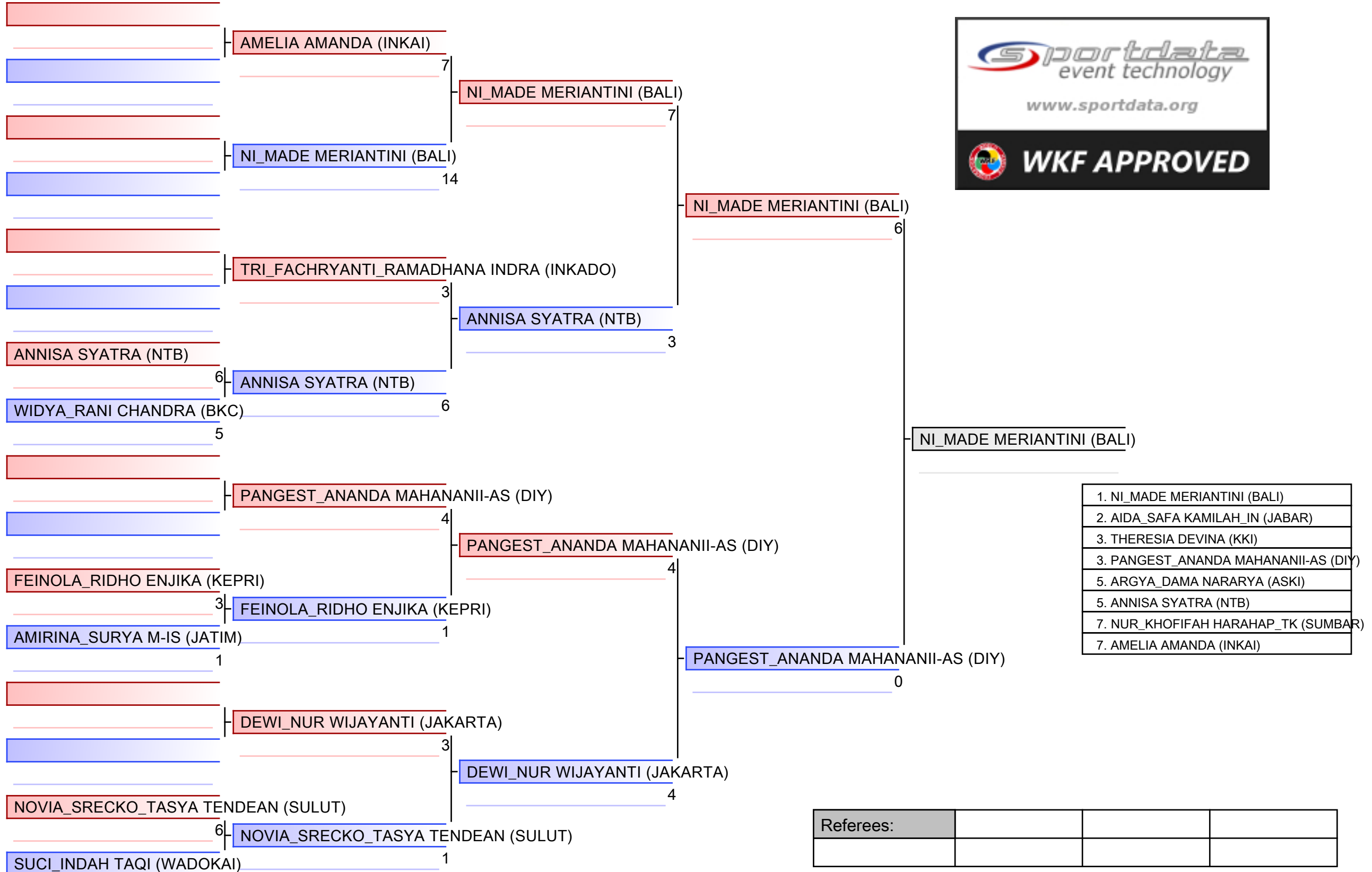

Referees:			

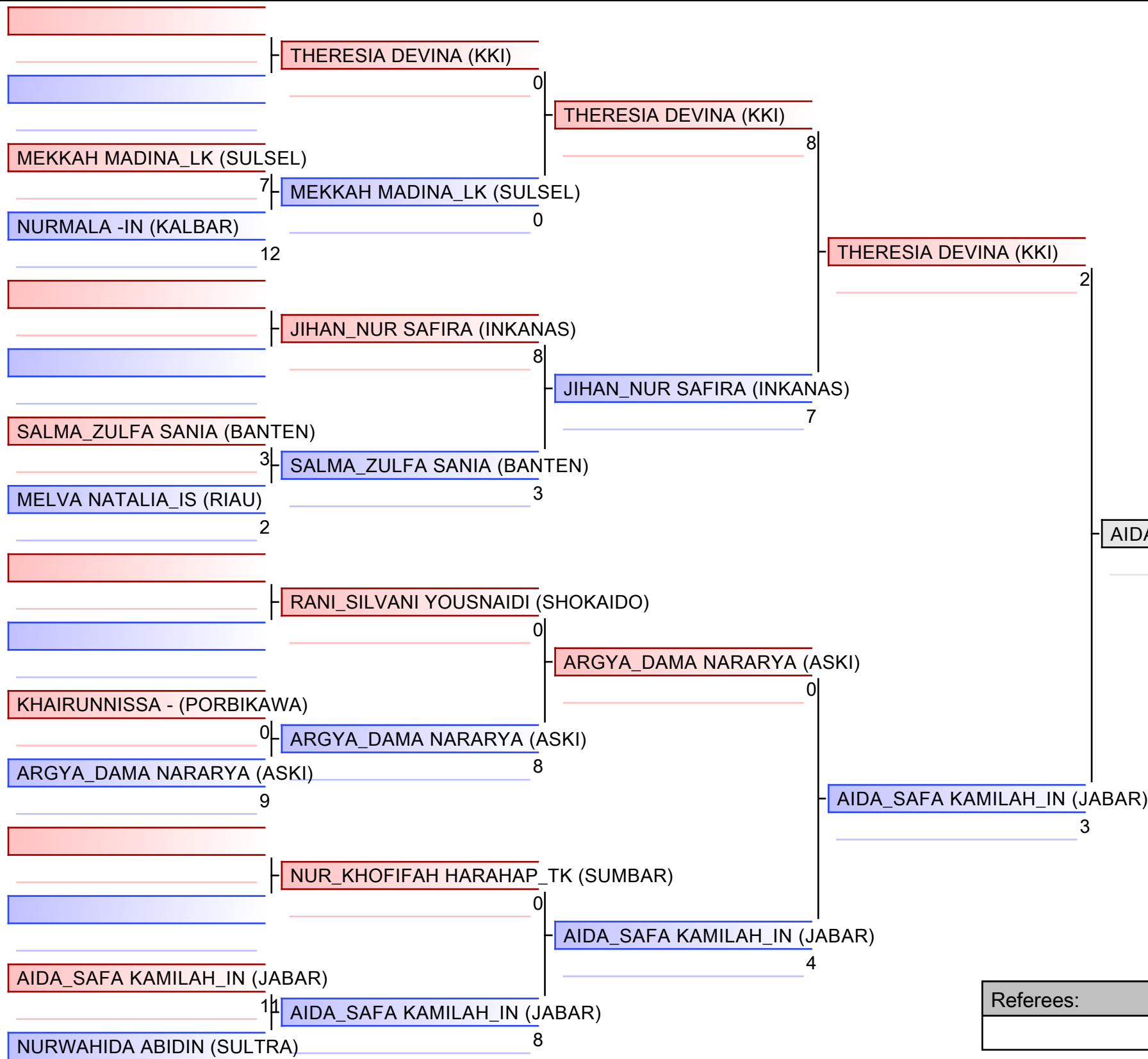

- | |
|---------------------------------------|
| 1. NI_MADE MERIANTINI (BALI) |
| 2. AIDA_SAFa KAMILAH_IN (JABAR) |
| 3. THERESIA DEVINA (KKI) |
| 3. PANGEST_ANANDA MAHANANII-AS (DIY) |
| 5. ARGYA_DAMA NARARYA (ASKI) |
| 5. ANNISA SYATRA (NTB) |
| 7. NUR_KHOFIFAH HARAHAHAP_TK (SUMBAR) |
| 7. AMELIA AMANDA (INKAI) |

Referees:			

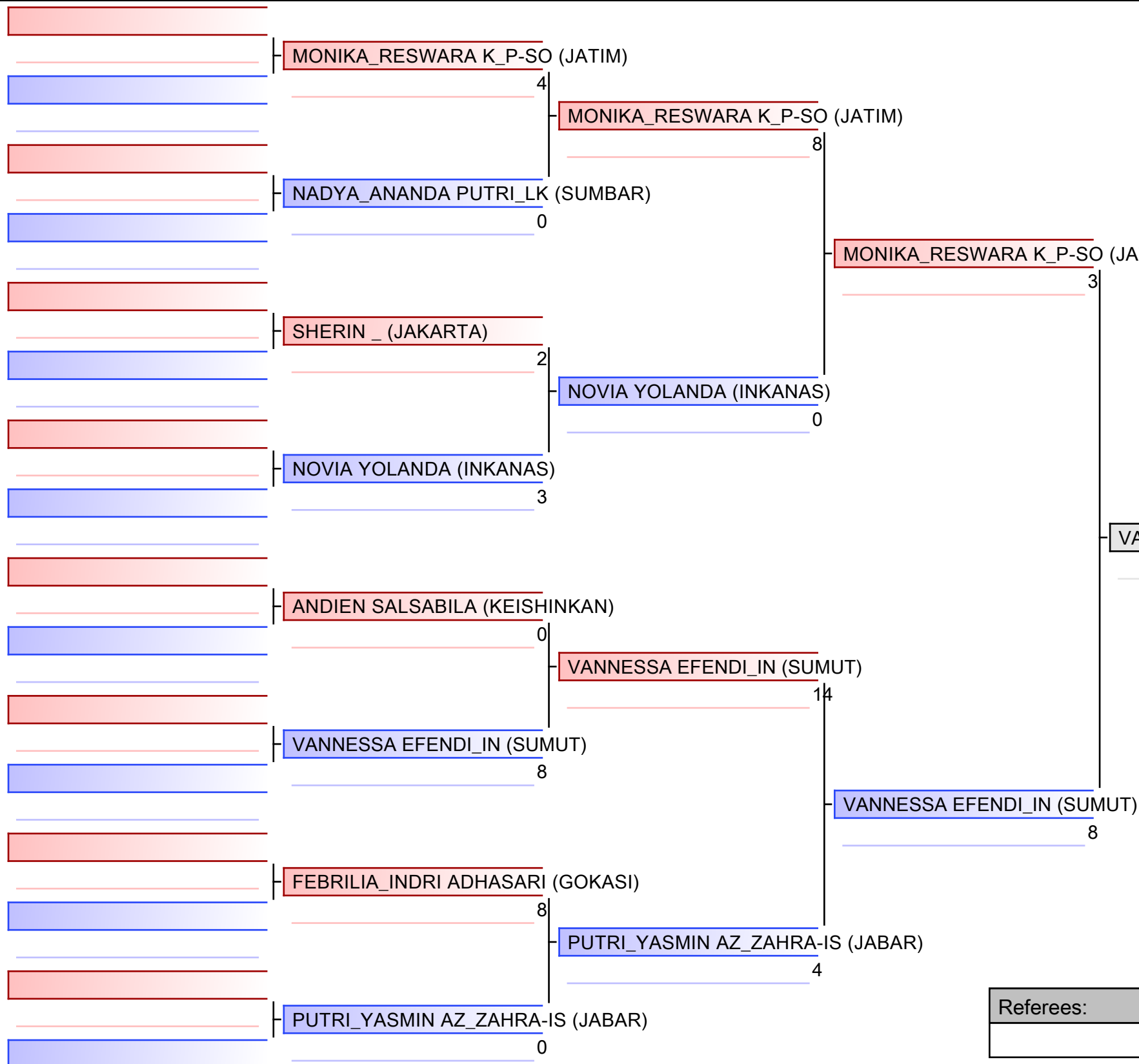

- | |
|-------------------------------------|
| 1. VANNESSA EFENDI_IN (SUMUT) |
| 2. AYU SULISTIANDARI-LK (LAMPUNG) |
| 3. MONIKA_RESWARA K_P-SO (JATIM) |
| 3. SALSABILA_RAGIL PUTRI (INKAI) |
| 5. PUTRI_YASMIN AZ_ZAHRA-IS (JABAR) |
| 5. ADIS_BUDI UTAMI (WADOKAI) |
| 7. ANDIEN SALSABILA (KEISHINKAN) |
| 7. CHINTIA_RIZKY_EKA PUTRI (BKC) |

Referees:			

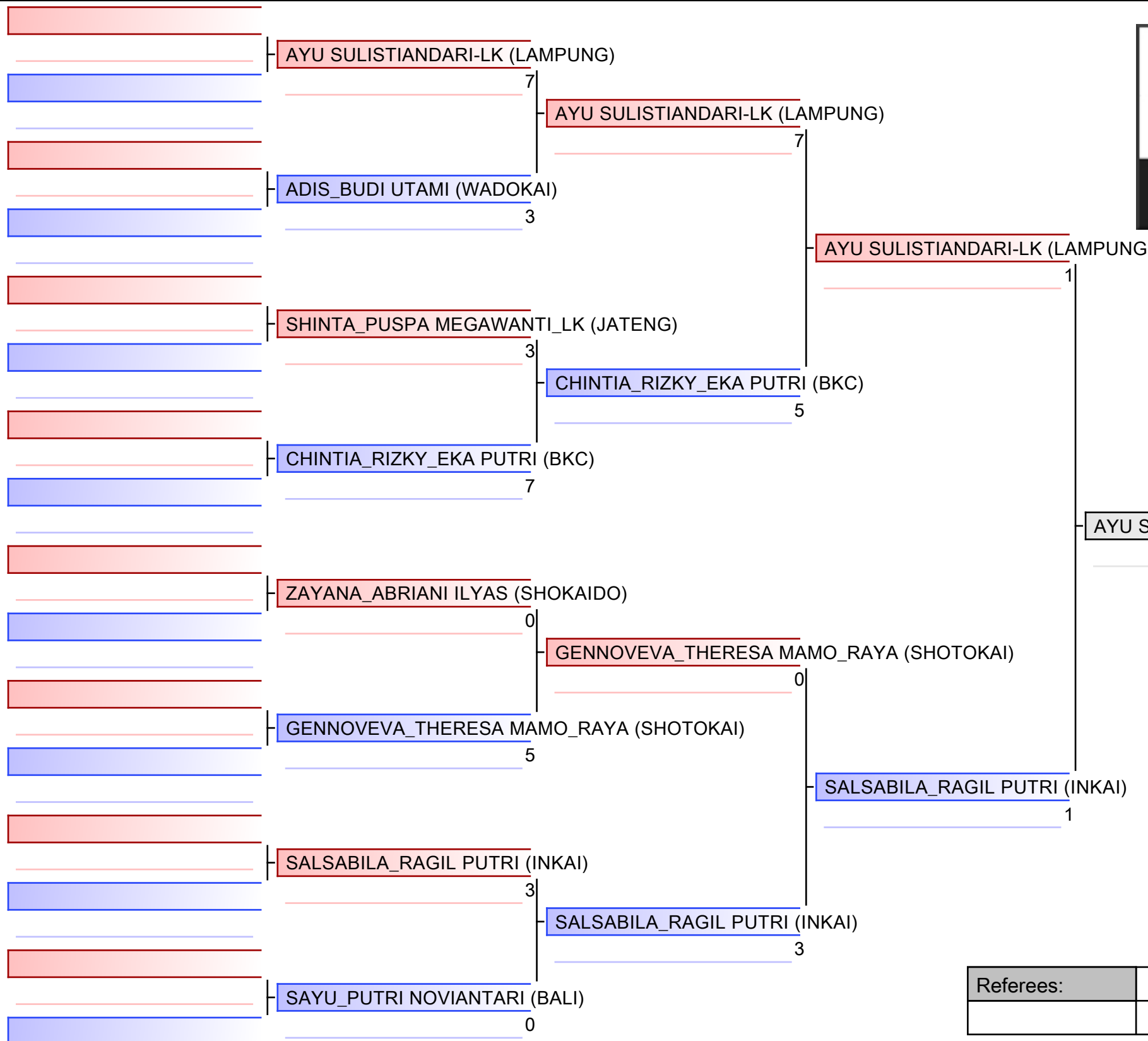

- | |
|-------------------------------------|
| 1. VANNESSA EFENDI_IN (SUMUT) |
| 2. AYU SULISTIANDARI-LK (LAMPUNG) |
| 3. MONIKA_RESWARA K_P-SO (JATIM) |
| 3. SALSABILA_RAGIL PUTRI (INKAI) |
| 5. PUTRI_YASMIN AZ_ZAHRA-IS (JABAR) |
| 5. ADIS_BUDI UTAMI (WADOKAI) |
| 7. ANDIEN SALSABILA (KEISHINKAN) |
| 7. CHINTIA_RIZKY_EKA PUTRI (BKC) |

Referees:			

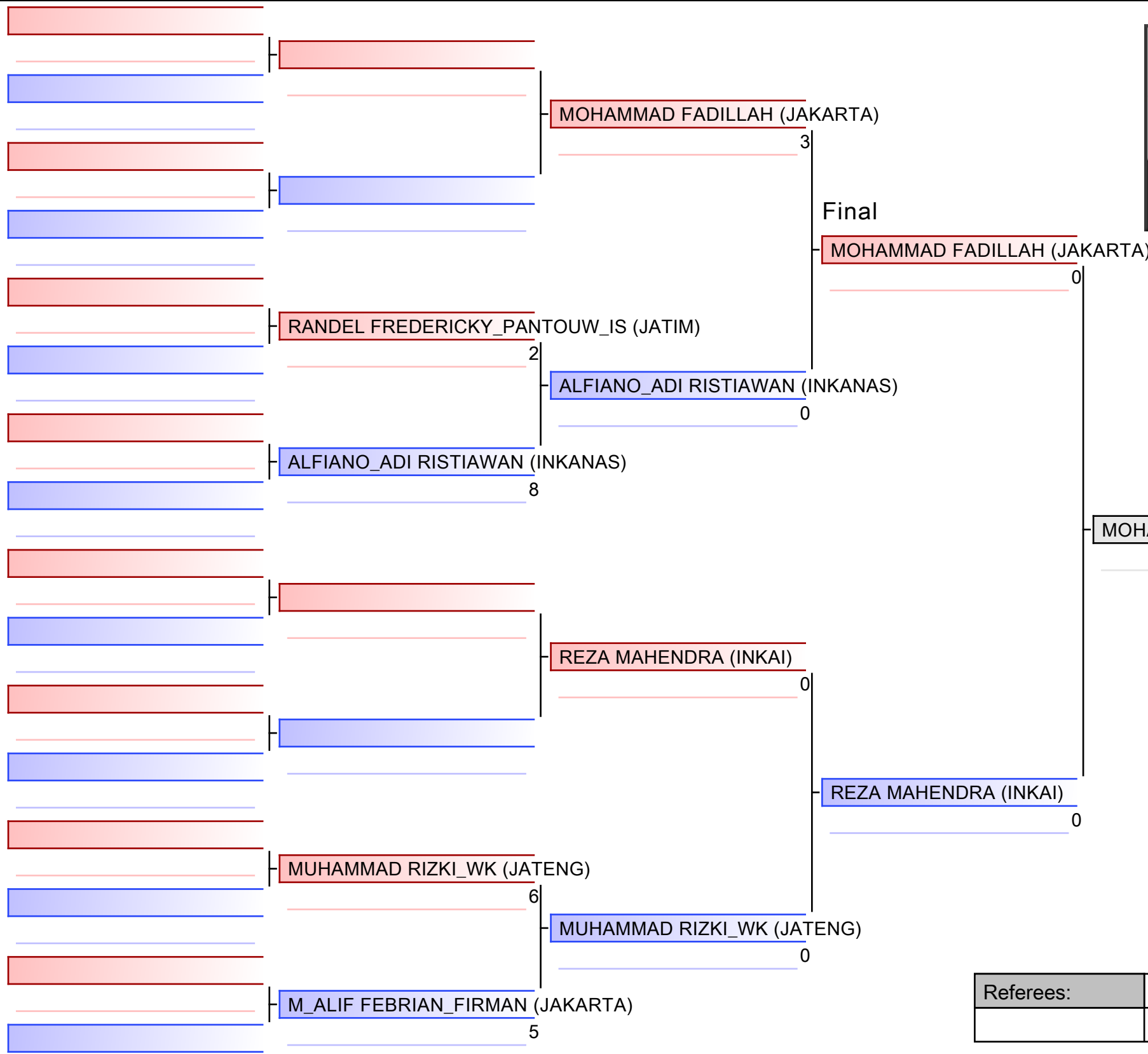

MOHAMMAD FADILLAH (JAKARTA)

1. MOHAMMAD FADILLAH (JAKARTA)
2. REZA MAHENDRA (INKAI)

Referees:			

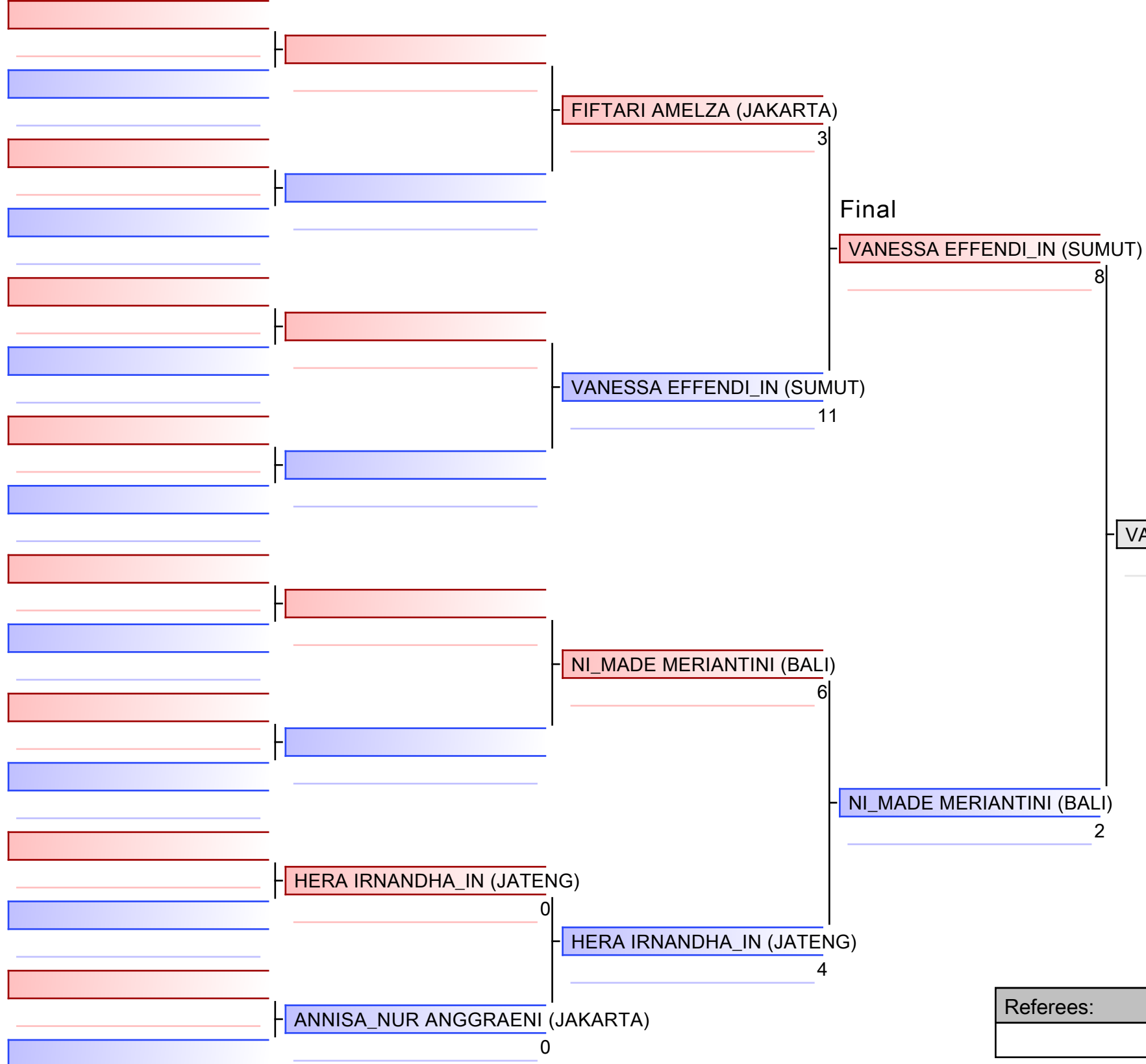

VANESSA EFFENDI_IN (SUMUT)

1. VANESSA EFFENDI_IN (SUMUT)
2. NI_MADE MERIANTINI (BALI)

Referees:			

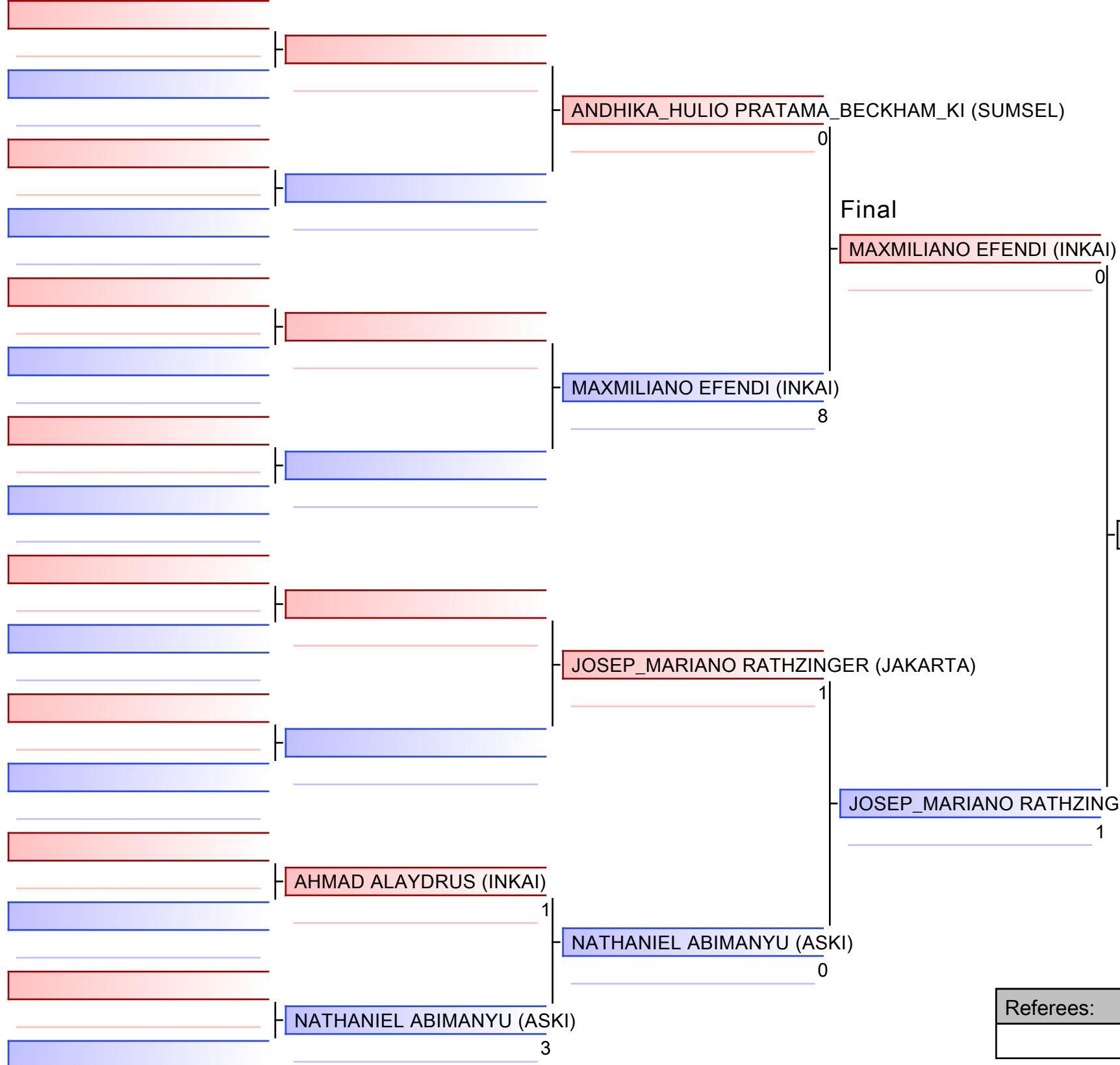

1. JOSEP_MARIANO RATHZINGER (JAKARTA)
2. MAXMILIANO EFENDI (INKAI)

Referees:			

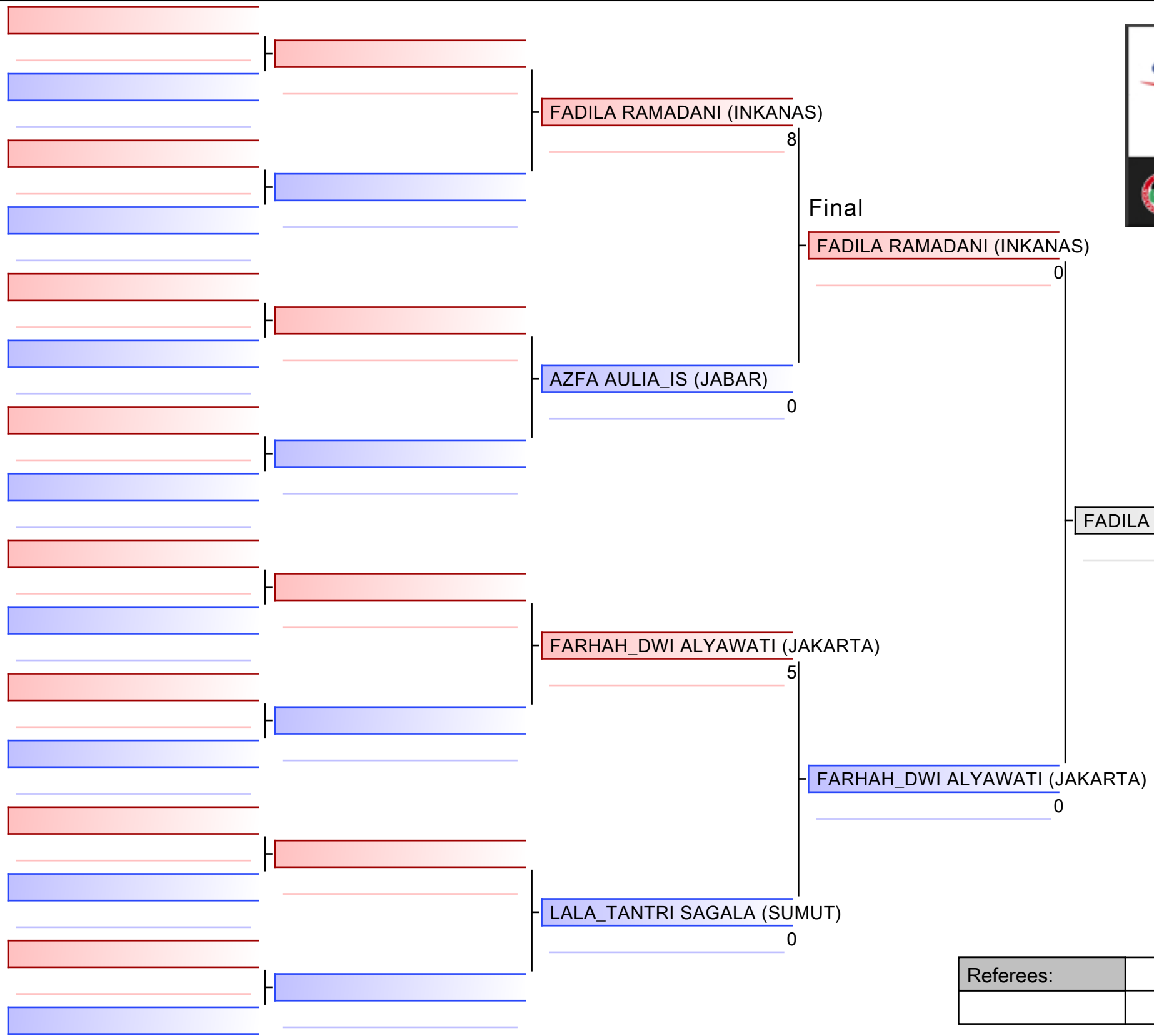

FADILA RAMADANI (INKANAS)

1. FADILA RAMADANI (INKANAS)
2. FARHAH_DWI ALYAWATI (JAKARTA)

Referees:			

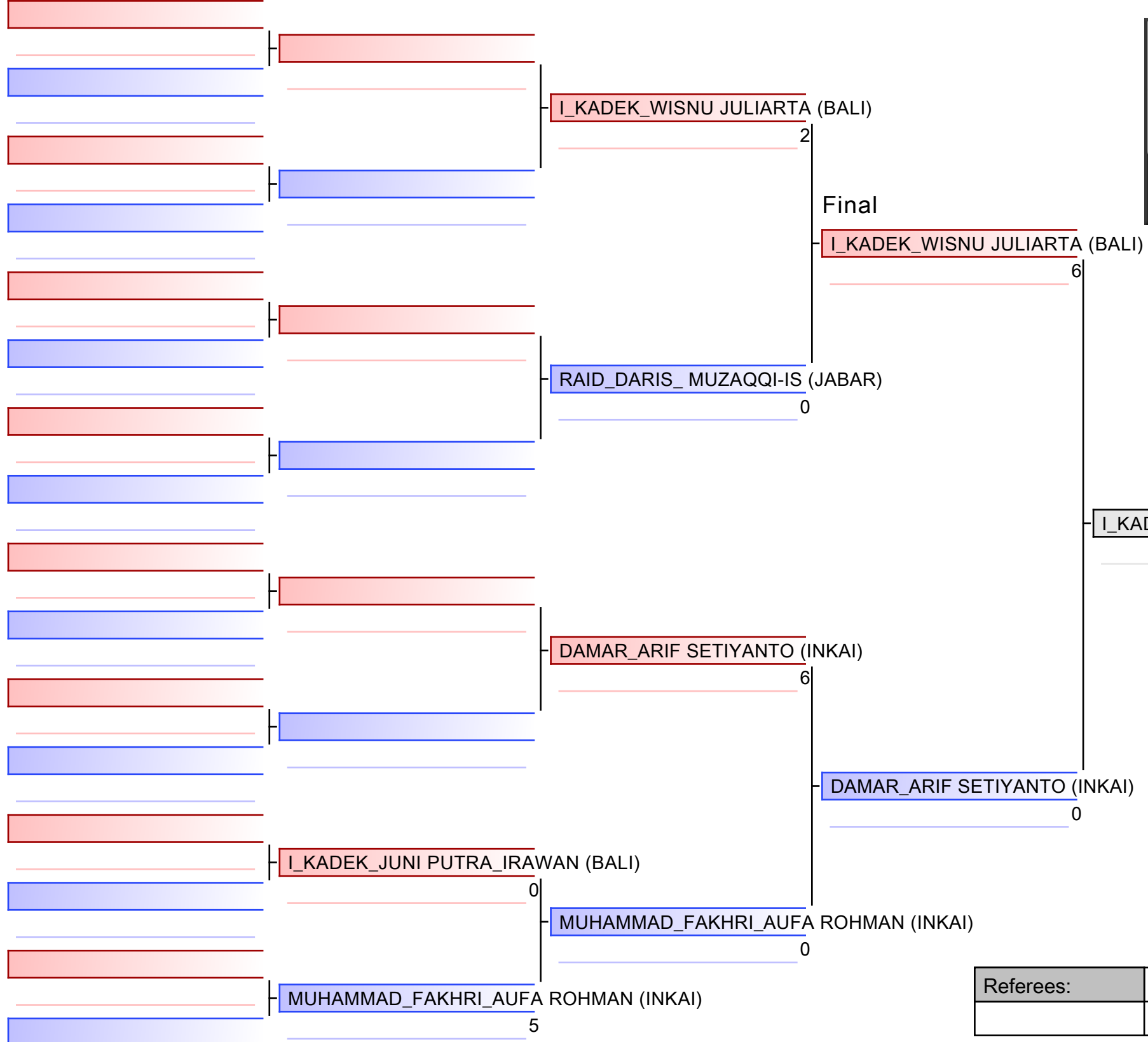

1. I_KADEK_WISNU JULIARTA (BALI)
2. DAMAR_ARIF SETIYANTO (INKAI)

Referees:			

BEST OF THE BEST KADET PUTRI - Round Robin (each against each)

KEJURNAS KARATE CADET, JUNIOR & U21 TAHUN 2021, INA

Tatami

Pool
1/1

- 1 ALMAHYRA_TIARA SANDI (INKANAS)
 3 | RISDA_JAYANTI MAHARDIKA-IN (JABAR)
- 2 RISDA_JAYANTI MAHARDIKA-IN (JABAR)
 3
- 3 ALMAHYRA_TIARA SANDI (INKANAS)
 2 | LUVENA MILANO_SETIYAKO_IN (JATENG)
- 4 LUVENA MILANO_SETIYAKO_IN (JATENG)
 6
- 5 RISDA_JAYANTI MAHARDIKA-IN (JABAR)
 0 | LUVENA MILANO_SETIYAKO_IN (JATENG)
- 6 LUVENA MILANO_SETIYAKO_IN (JATENG)
 10



1. LUVENA MILANO_SETIYAKO_IN (JATENG)
2. RISDA_JAYANTI MAHARDIKA-IN (JABAR)
3. ALMAHYRA_TIARA SANDI (INKANAS)

Referees:				

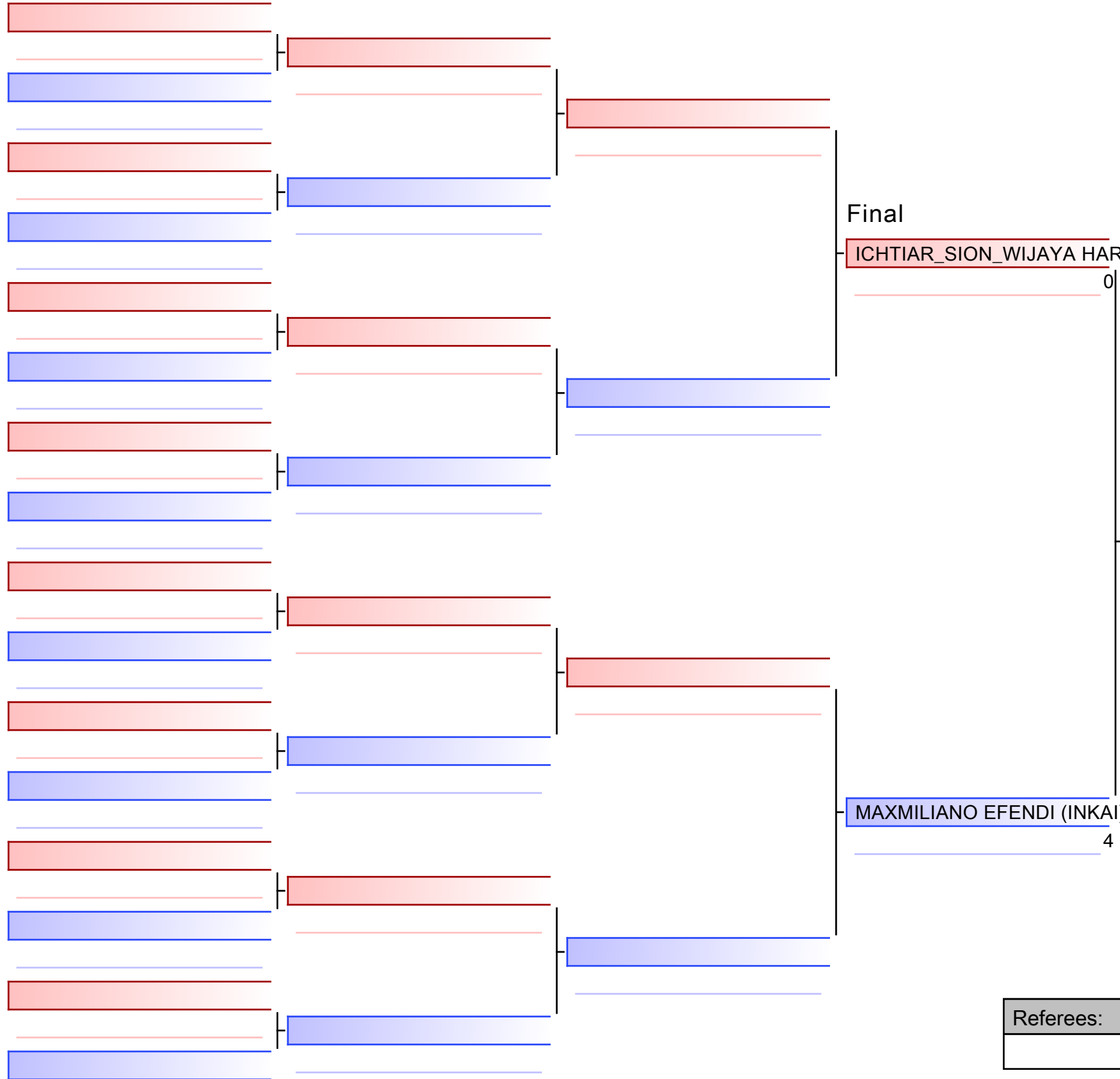

Final

ICHTIAR_SION_WIJAYA HAREFA (TAKO)

0

MAXMILIANO EFENDI (INKAI)

MAXMILIANO EFENDI (INKAI)

4

- | |
|--------------------------------------|
| 1. MAXMILIANO EFENDI (INKAI) |
| 2. ICHTIAR_SION_WIJAYA HAREFA (TAKO) |
| 3. RIZKY ADHA_TK (RIAU) |
| 3. GERI_MAULANA HUTAPEA (KEPRI) |
| 5. FADLI SEPRIYADI_ID (SUMBAR) |
| 5. JOEL_MARTOGAP GULTOM (SHIROITE) |
| 7. RIZKY RAMADHAN-LK (JABAR) |
| 7. RIZKY ADITRI_ROZAL (LEMKARI) |

Referees:			

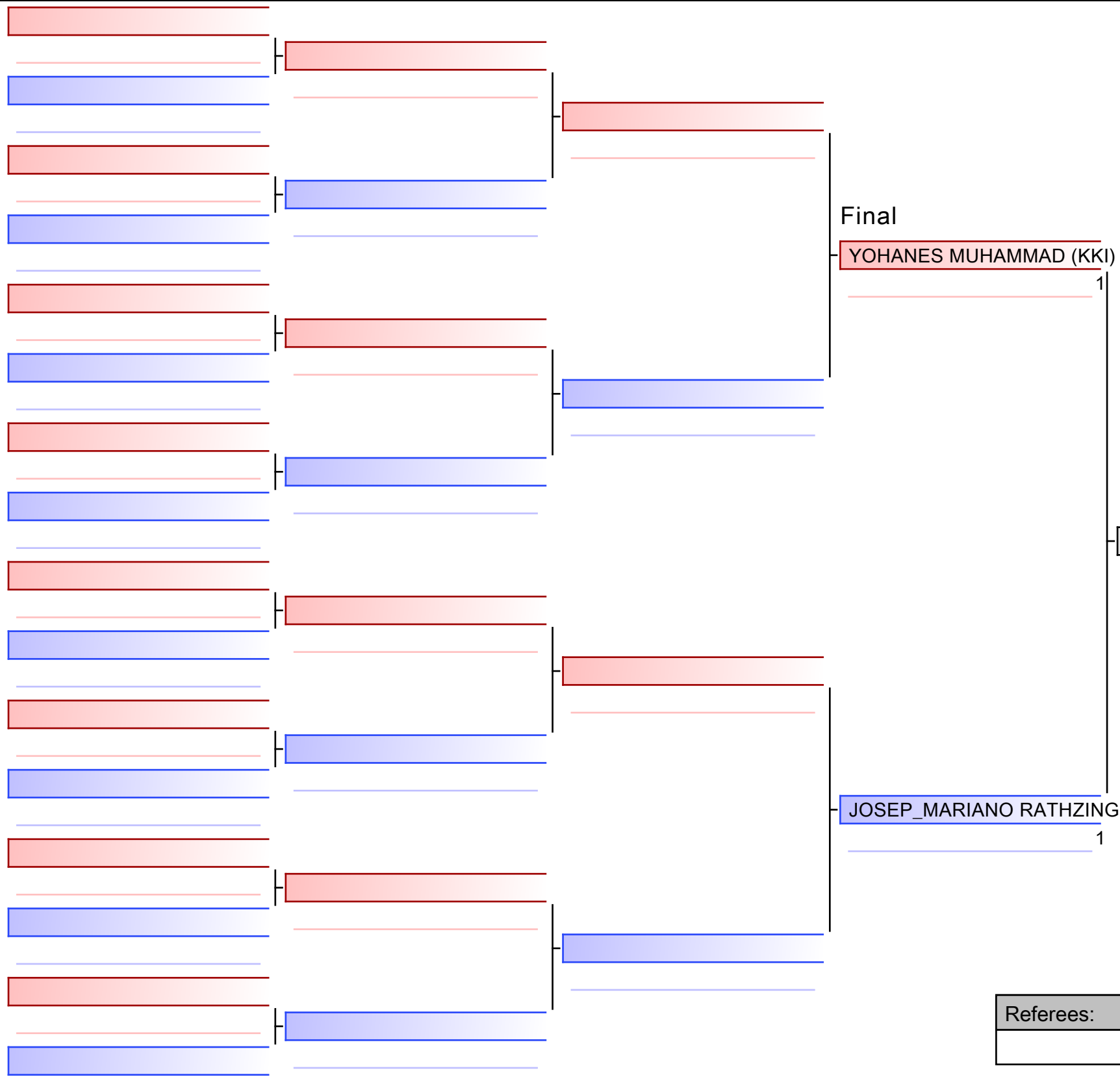

JOSEP_MARIANO RATHZINGER (JAKARTA)

JOSEP_MARIANO RATHZINGER (JAKARTA)

- | |
|--|
| 1. JOSEP_MARIANO RATHZINGER (JAKARTA) |
| 2. YOHANES MUHAMMAD (KKI) |
| 3. ROMANUS LUTT_LUKAS_ID (PAPUA BARAT) |
| 3. MOCHAMAD_ALWI MARASABESSY (BUDOKAI) |
| 5. JOSEPH SIMATUPANG (INKANAS) |
| 5. LALU_MUHAMMAD TATAS (PAPUA BARAT) |
| 7. BAHRUL IHSAN-IN (DIY) |
| 7. ANDI_FAHMI FAHRI (NTB) |

Referees:			

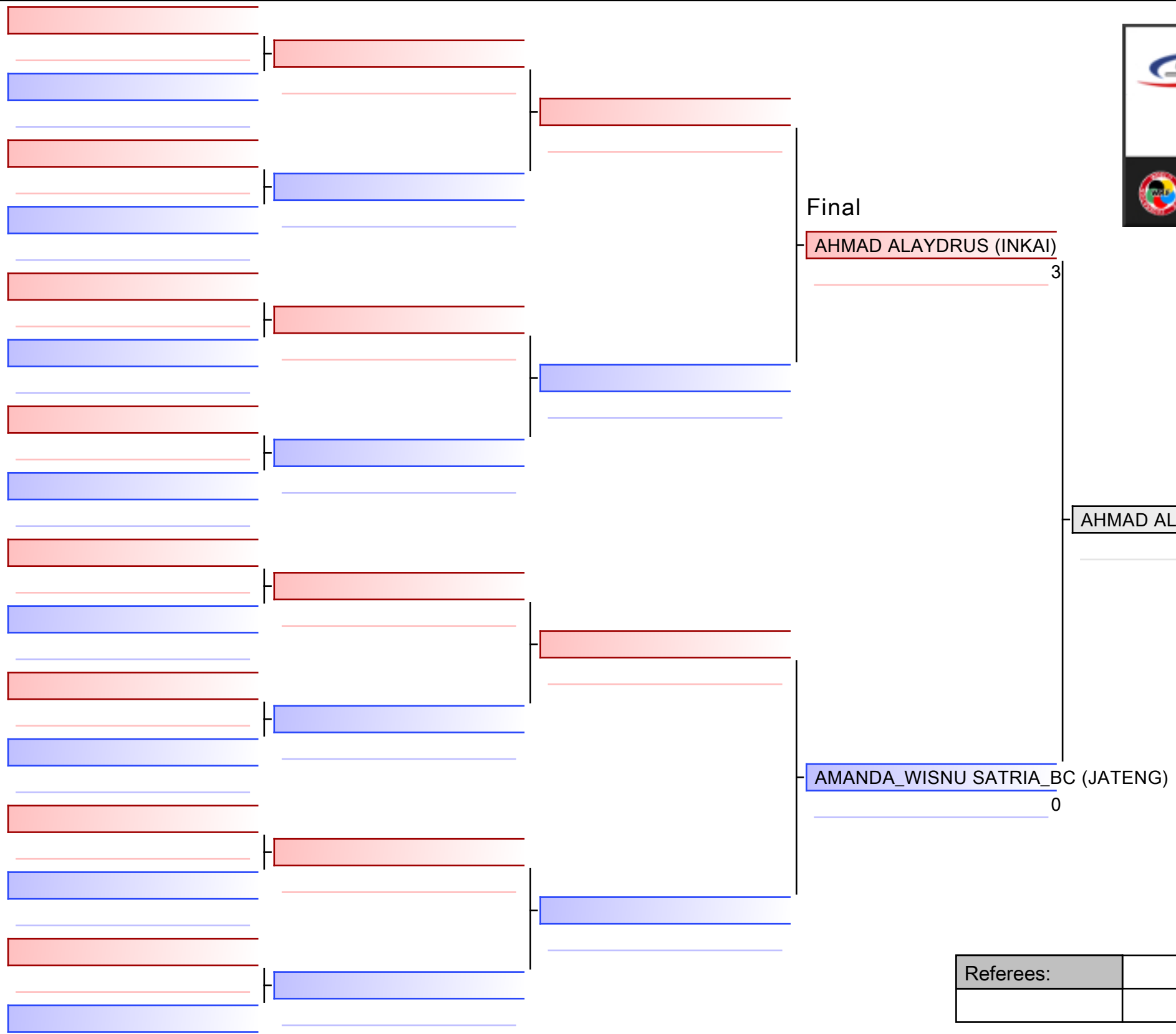

- | |
|--|
| 1. AHMAD ALAYDRUS (INKAI) |
| 2. AMANDA_WISNU SATRIA_BC (JATENG) |
| 3. MUHAMMAD_GHALIB RAMADHAN-IN (JABAR) |
| 3. DAIVA MAHADANA (JAKARTA) |
| 5. ARYA_RIZKY RAMADHAN (INKANAS) |
| 5. ANGGEL_DASRIAL PUTRA (INKADO) |
| 7. MUHAMMAD AL_FARISI (GOKASI) |
| 7. LALU_MUHAMMAD AZWIN (NTB) |

Referees:			

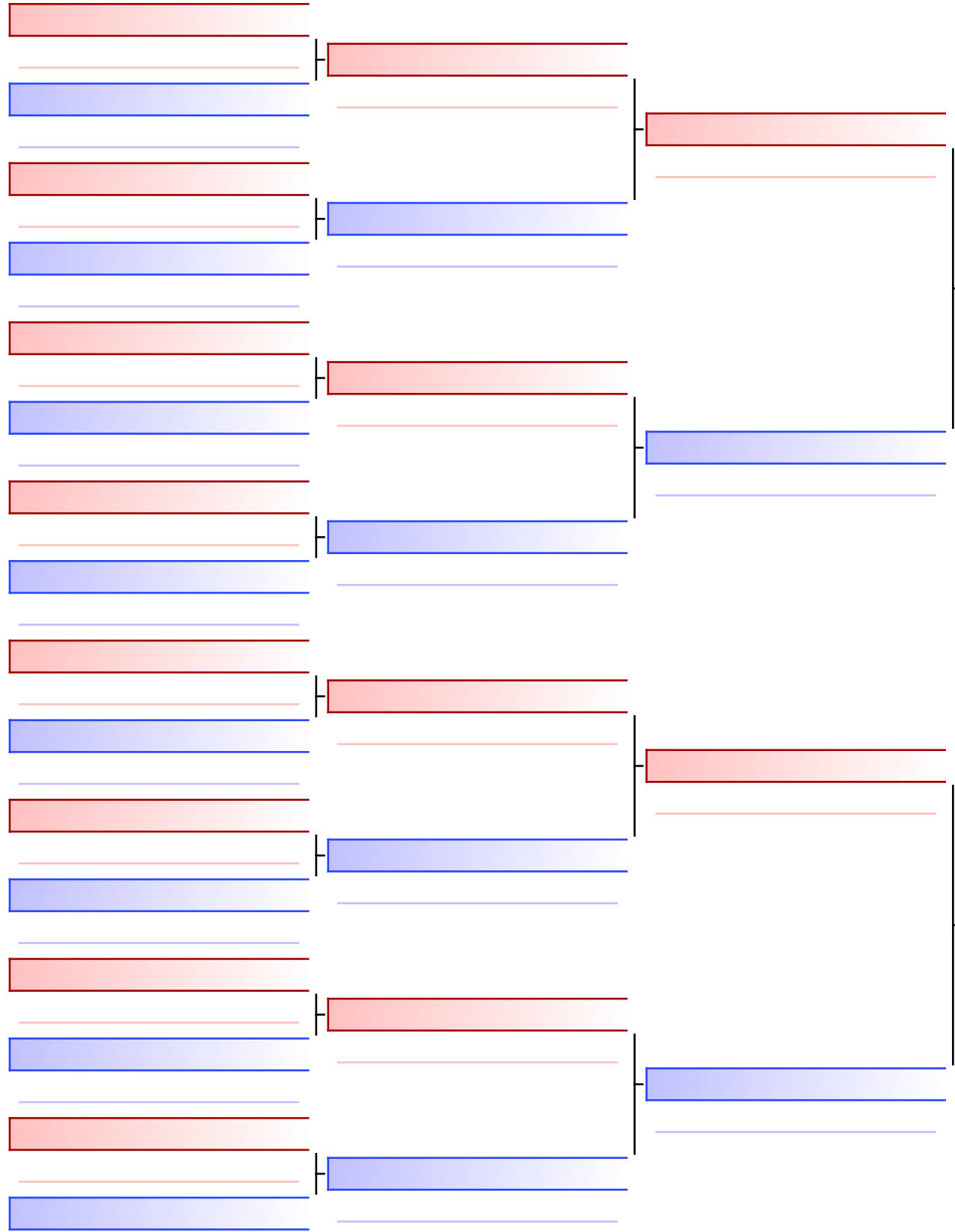

Final

GILANG_PERMANA AJIE (INKAI)

1

ANDHIKA_HULIO PRATAMA_BECKHAM_KI (SUMSEL)

ANDHIKA_HULIO PRATAMA_BECKHAM_KI (SUMSEL)

1

- | |
|--|
| 1. ANDHIKA_HULIO PRATAMA_BECKHAM_KI (SUMSEL) |
| 2. GILANG_PERMANA AJIE (INKAI) |
| 3. GILANG_RAMADHAN RAMBE-BC (LAMPUNG) |
| 3. AKBAR_TYO PAMUNGKAS (DIY) |
| 5. RENDITYA_HIKMAL ARYANTARA (INKANAS) |
| 5. ALIEF FEBRIANTO (JAKARTA) |
| 7. DIKSON_MULIA PARDEDE (KEPRI) |
| 7. SANDY ADRIAN_PUTRA (NTB) |

Referees:			

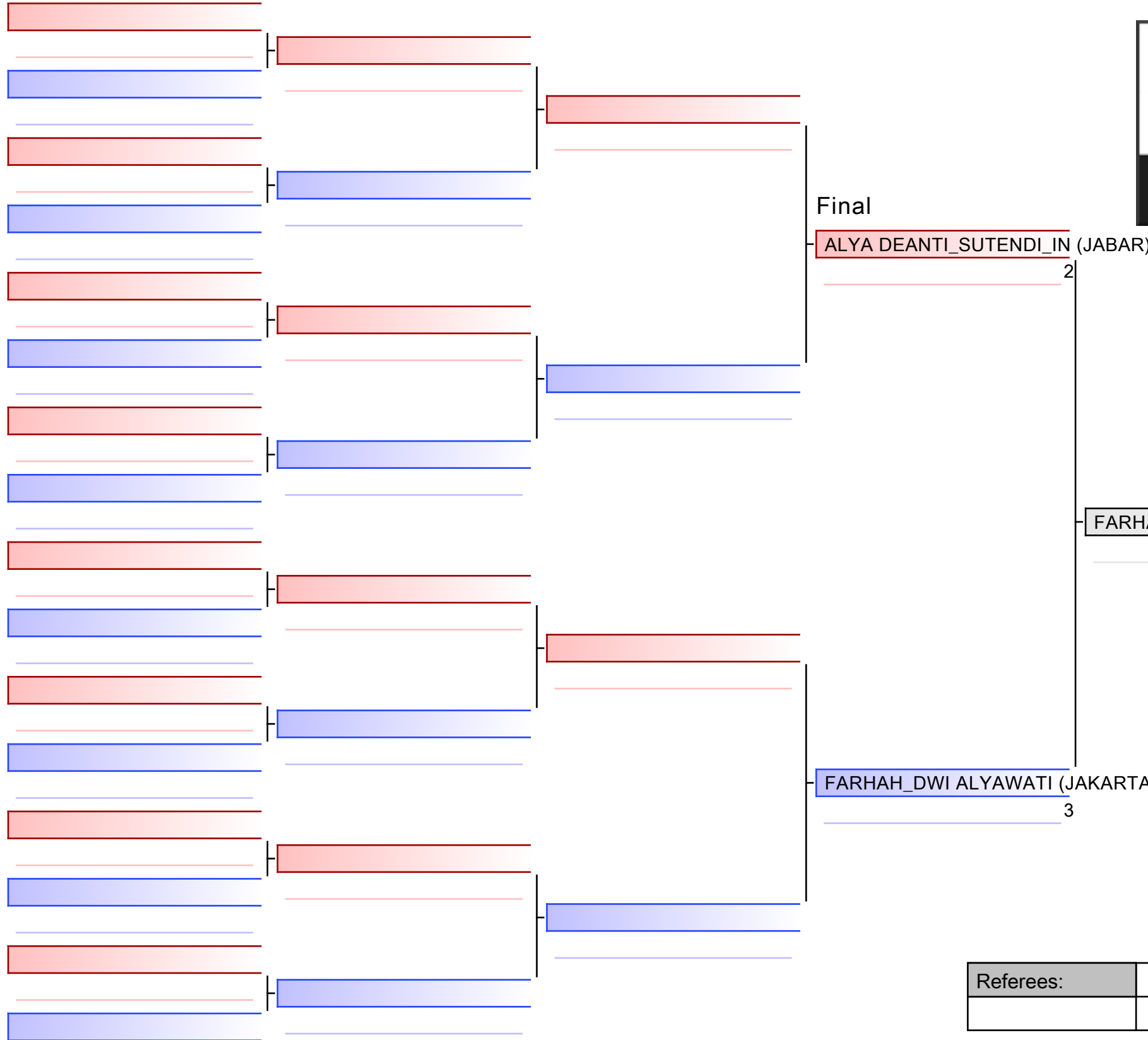

FARHAH_DWI ALYAWATI (JAKARTA)

- | |
|------------------------------------|
| 1. FARHAH_DWI ALYAWATI (JAKARTA) |
| 2. ALYA DEANTI_SUTENDI_IN (JABAR) |
| 3. BENEDICTA_RIEDA LARASATI (ASKI) |
| 3. RAINA SALMA (INKAI) |
| 5. YOHANA_ADELL REGAR (SULUT) |
| 5. HAJJARIAH ANGGRAINI-IN (KALBAR) |
| 7. DAMAYANTI -KI (KALTIM) |
| 7. HASNA HAPSARI_IS (JATENG) |

Referees:			

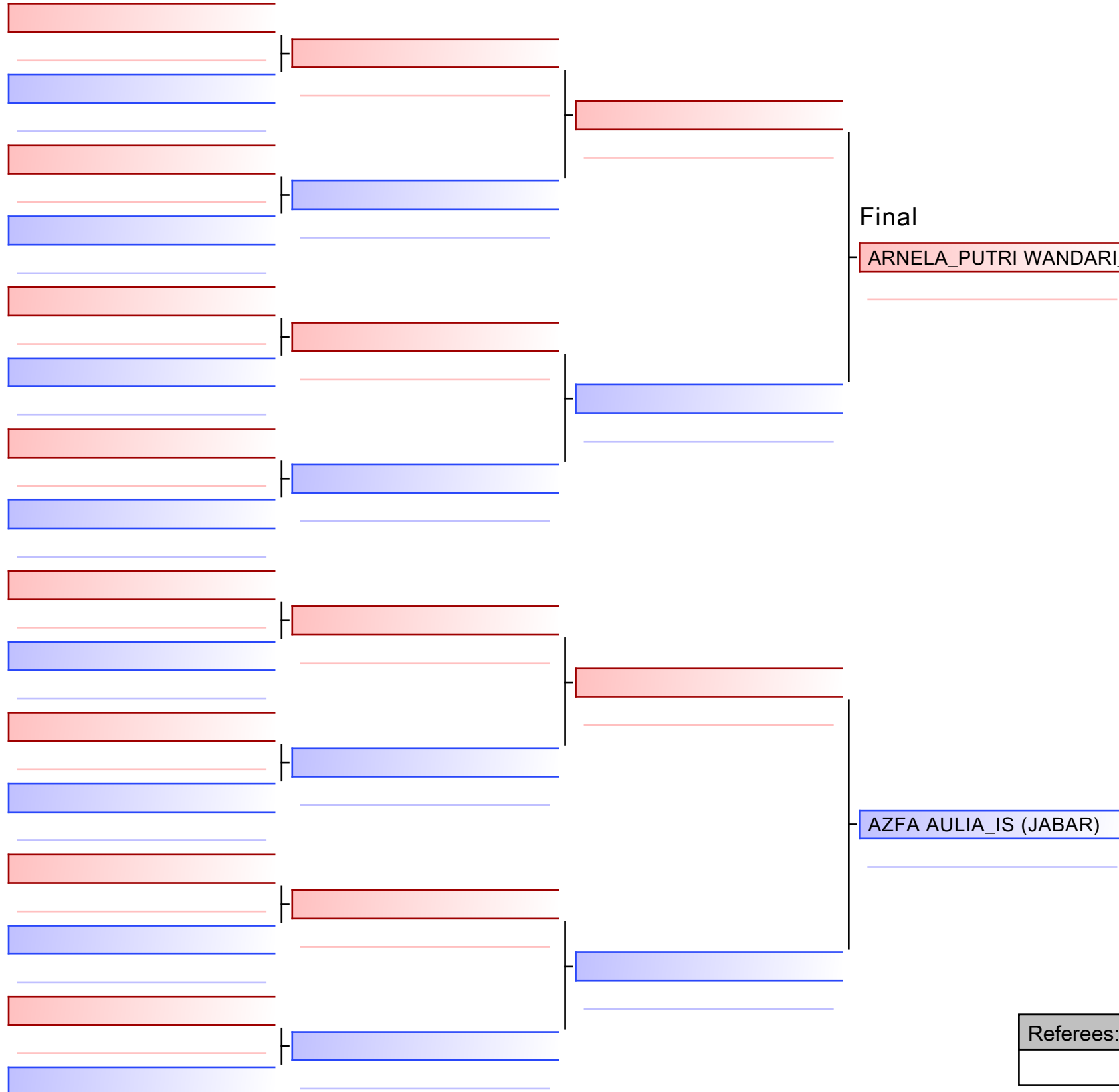

- | |
|---|
| 1. AZFA AULIA_IS (JABAR) |
| 2. ARNELA_PUTRI WANDARI_WK (SUMUT) |
| 3. NI_RAI_BINTANG PUTRI_FAJARANI (BALI) |
| 3. SALSA_G_P WAHONO-IKD (SULUT) |
| 5. RAMADHANI PANE (SHIROITE) |
| 5. FINALIRIN_ (INKANAS) |
| 7. RESTU DWIANSYAH (FUNAKOSHI) |
| 7. CHIKITA HANDRIANA (BANTEN) |

Referees:			

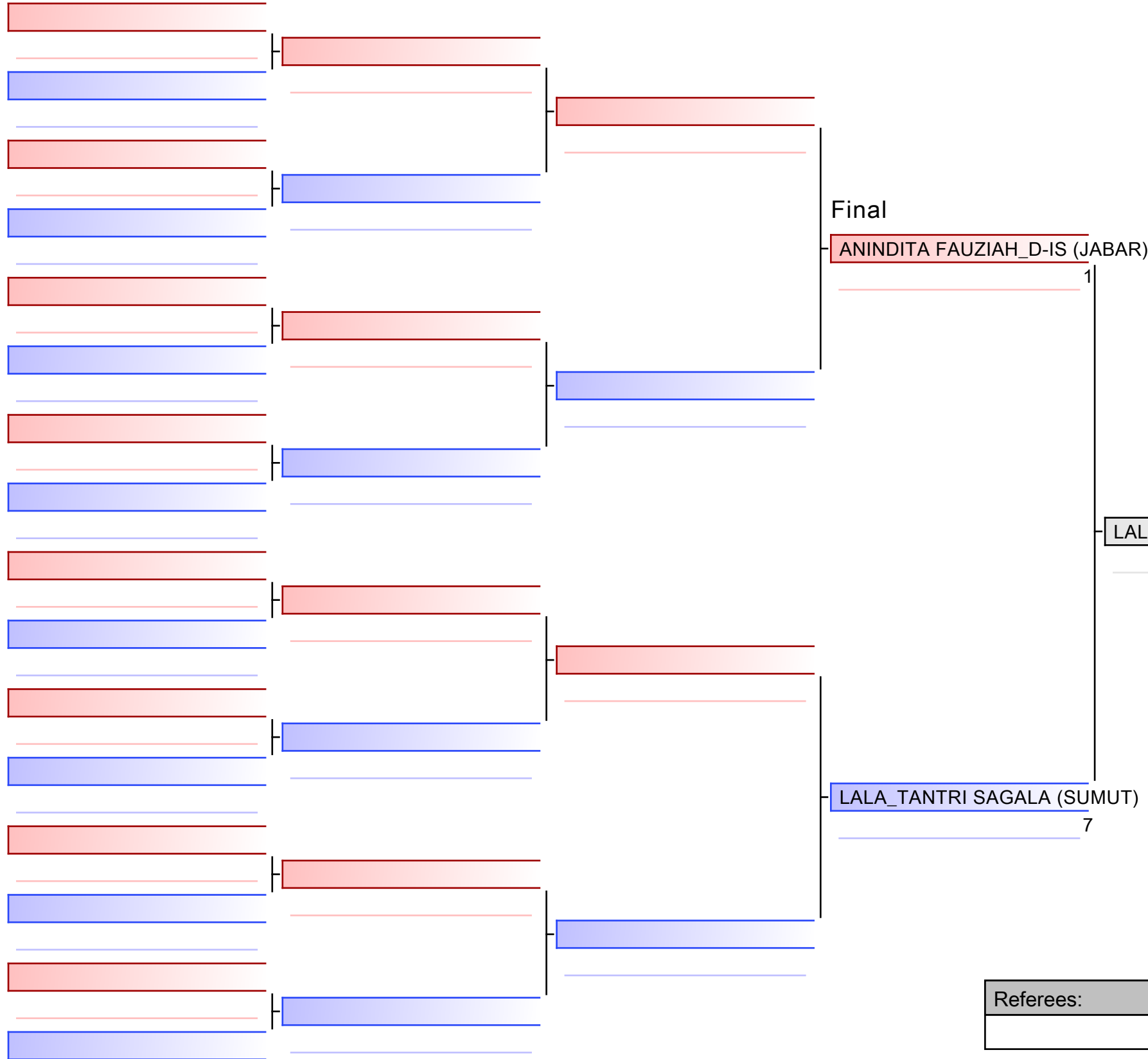

LALA_TANTRI SAGALA (SUMUT)

- | |
|---|
| 1. LALA_TANTRI SAGALA (SUMUT) |
| 2. ANINDITA FAUZIAH_D-IS (JABAR) |
| 3. NAJWA SABILA_HABIBIE_IS (GORONTALO) |
| 3. NI_MADE_DWI_KARTIKA APRIANTI (BALI) |
| 5. I_GUSTI_AGUNG_KETUT ADINDA_BELIA_LK (BANTEN) |
| 5. MELINDA_EKA PRATIWI-AS (DIY) |
| 7. ZAHRA_RAHMA QALBINA (KEPRI) |
| 7. MAYANG_FAUZIAH PUTRI (INKAI) |

Referees:			

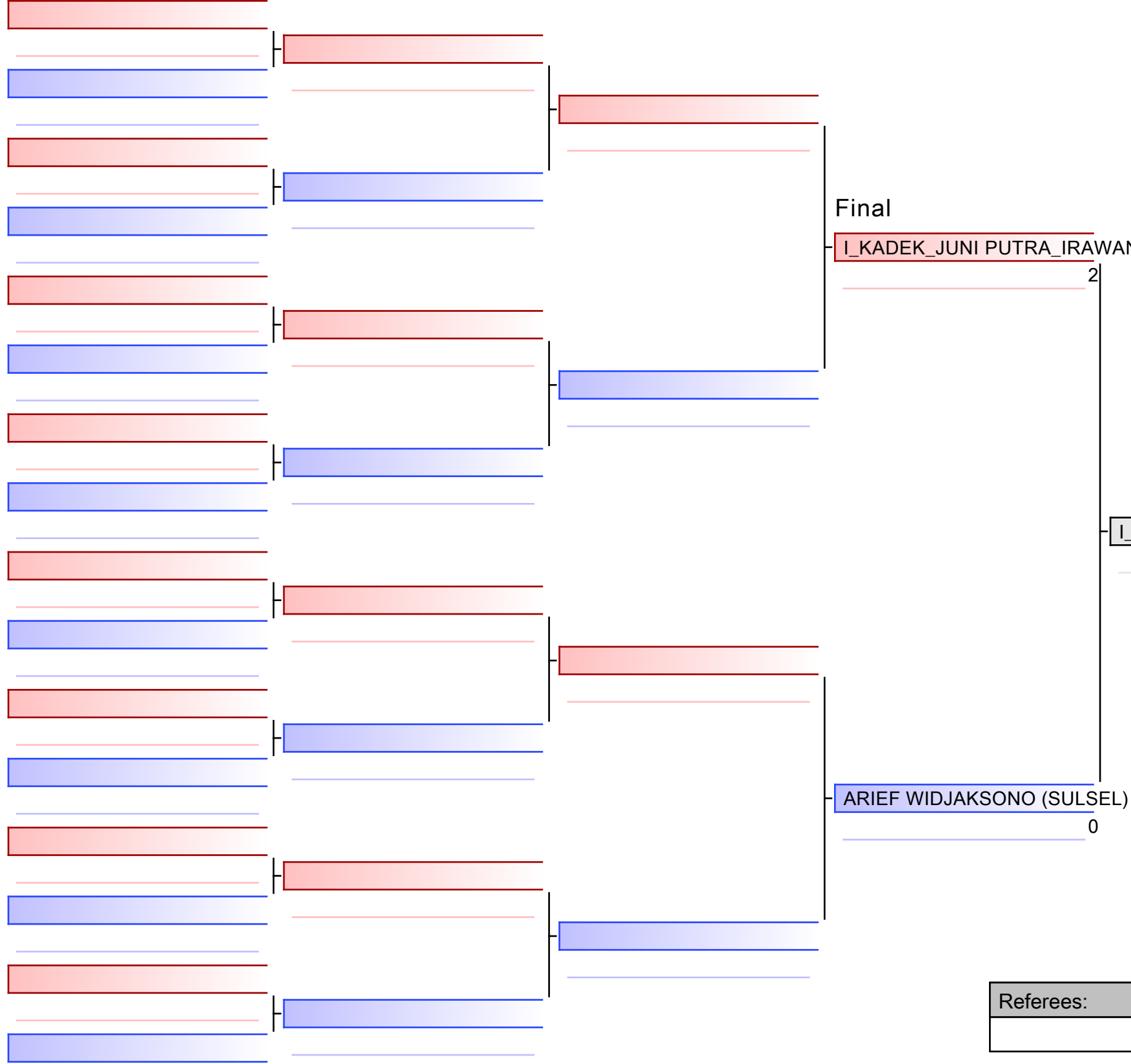

I_KADEK_JUNI PUTRA_IRAWAN (BALI)

- | |
|--|
| 1. I_KADEK_JUNI PUTRA_IRAWAN (BALI) |
| 2. ARIEF WIDJAKSONO (SULSEL) |
| 3. MOCHAMAD RAFAEL (INKANAS) |
| 3. FAHREL_APRIYANSYAH AMARTHA-KI (LAMPUNG) |
| 5. DHIAZ SHOBHI-BC (BENGKULU) |
| 5. MORI_DAFFA_HILMAN ROSYAD_KI (JABAR) |
| 7. MUHAMMAD_ABIMEYZHAR NUGRAHA (GOJUK) |
| 7. MUHAMMAD FARKHAM (LEMKARI) |

Referees:			

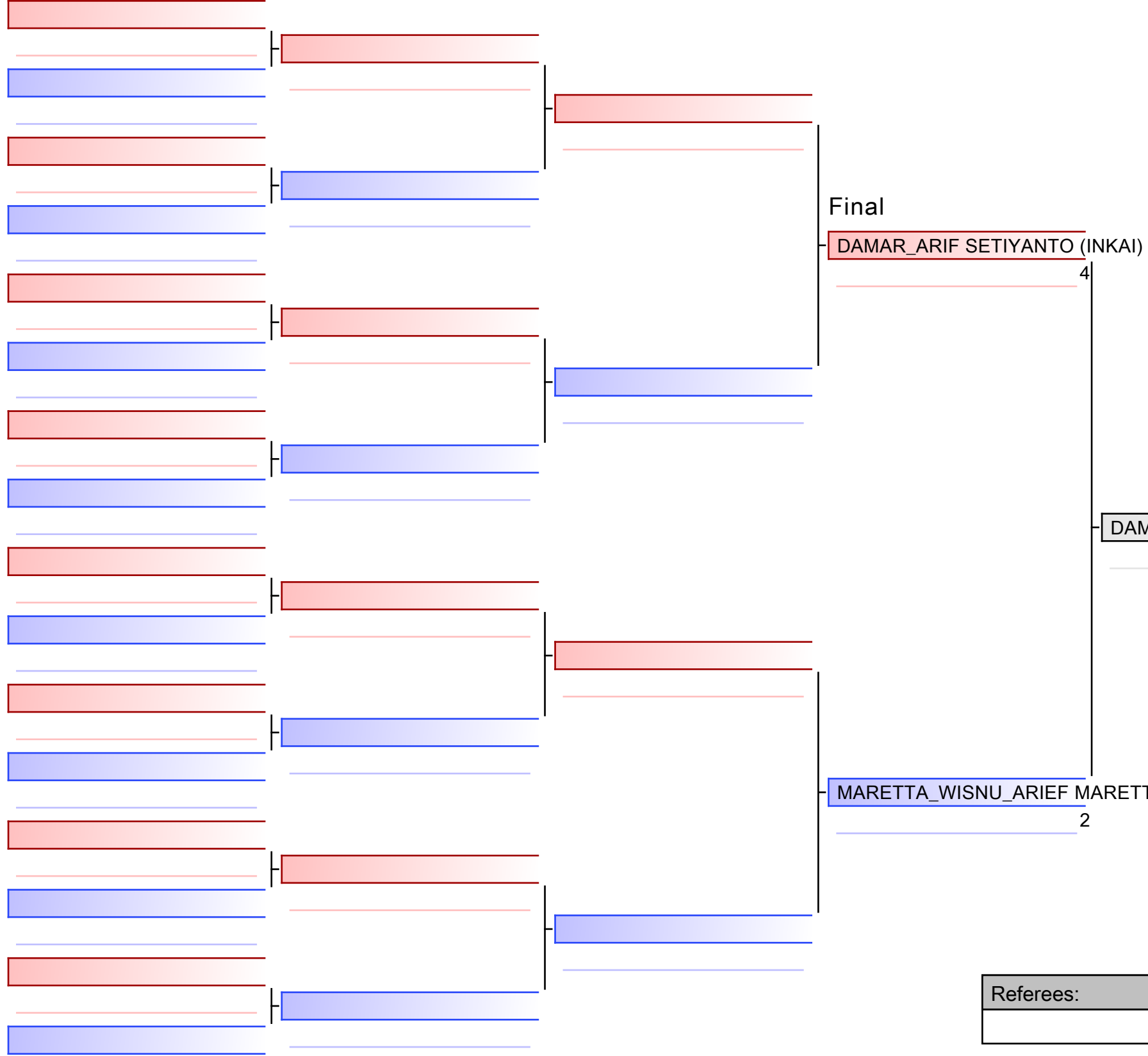

Final

DAMAR_ARIF SETIYANTO (INKAI)
 4

DAMAR_ARIF SETIYANTO (INKAI)

MARETTA_WISNU_ARIEF MARETTA_WISNU_ARIEF_AS (JATENG)
 2

- 1. DAMAR_ARIF SETIYANTO (INKAI)
- 2. MARETTA_WISNU_ARIEF MARETTA_WISNU_A
- 3. M_ARIQ AL_HAKIM-KI (LAMPUNG)
- 3. LINGGA KURNIAWAN (ASKI)
- 5. I_GEDE_FARAND_DARMIKA ANANDE (KKI)
- 5. MUHAMAD_MUFLI AWALIA_RAMADAN (BANTE
- 7. AKHBAR_PASYAH PURNOMO (BKC)
- 7. M_IKHSAN SAFRUDIN (SULSEL)

Referees:			

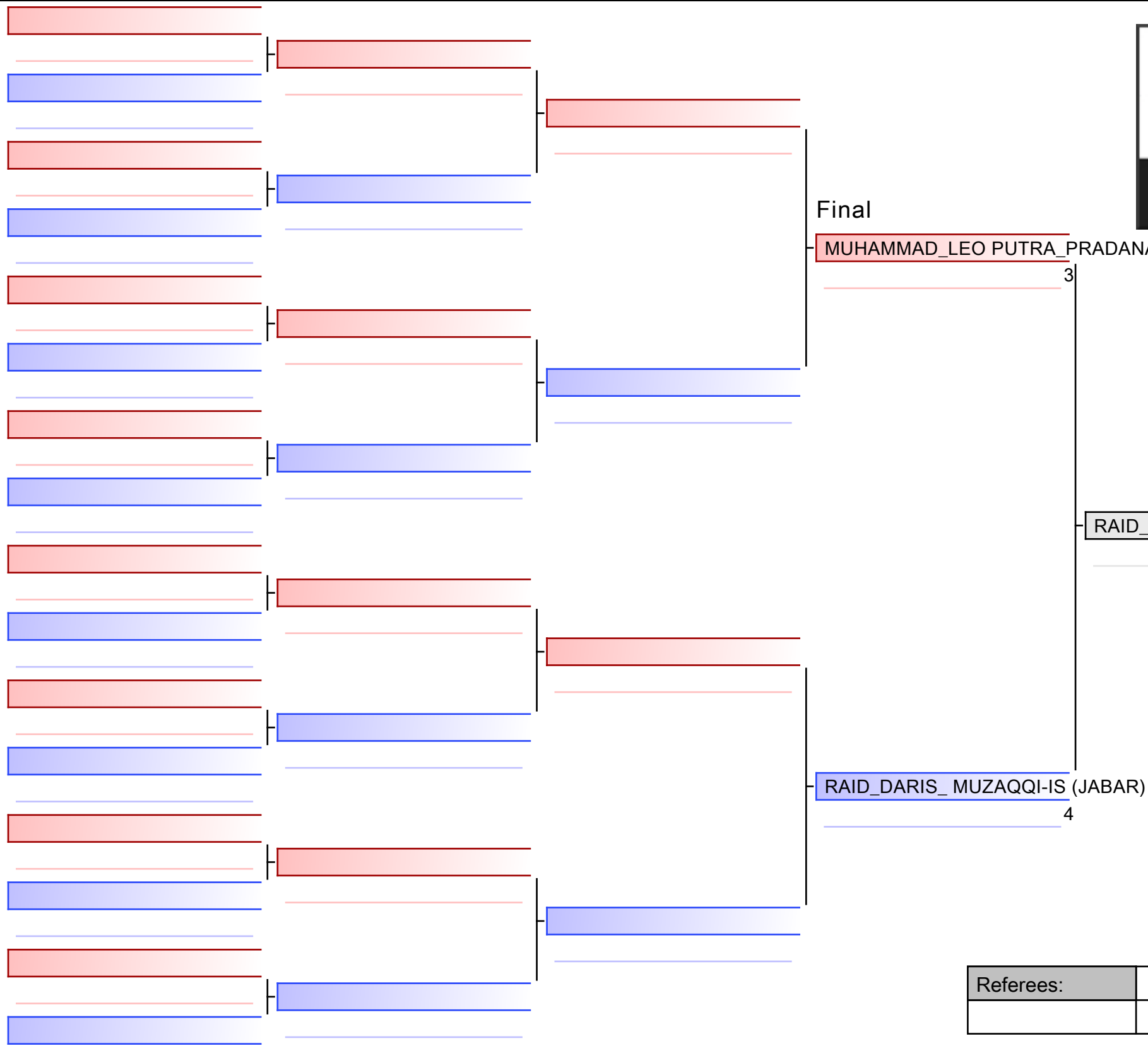

Final

MUHAMMAD_LEO PUTRA_PRADANA (INKAI)

3

RAID_DARIS_MUZAQQI-IS (JABAR)

RAID_DARIS_MUZAQQI-IS (JABAR)

4

- | |
|--|
| 1. RAID_DARIS_MUZAQQI-IS (JABAR) |
| 2. MUHAMMAD_LEO PUTRA_PRADANA (INKAI) |
| 3. I_GUSTI_AGUNG_BRAHMANTRA GAYATH_W (|
| 3. MICHEL_CHARIS KARWUR (SULUT) |
| 5. ANUGERAH_NABIL RANGGAWIJAYA (ASKI) |
| 5. MUH RAIHAN_IN (SULTENG) |
| 7. JOAN_HEBERT_TULUS SIBURIAN (SHOKAIDO) |
| 7. IRVAN_MAHMUD PRATAMA (BABEL) |

Referees:			

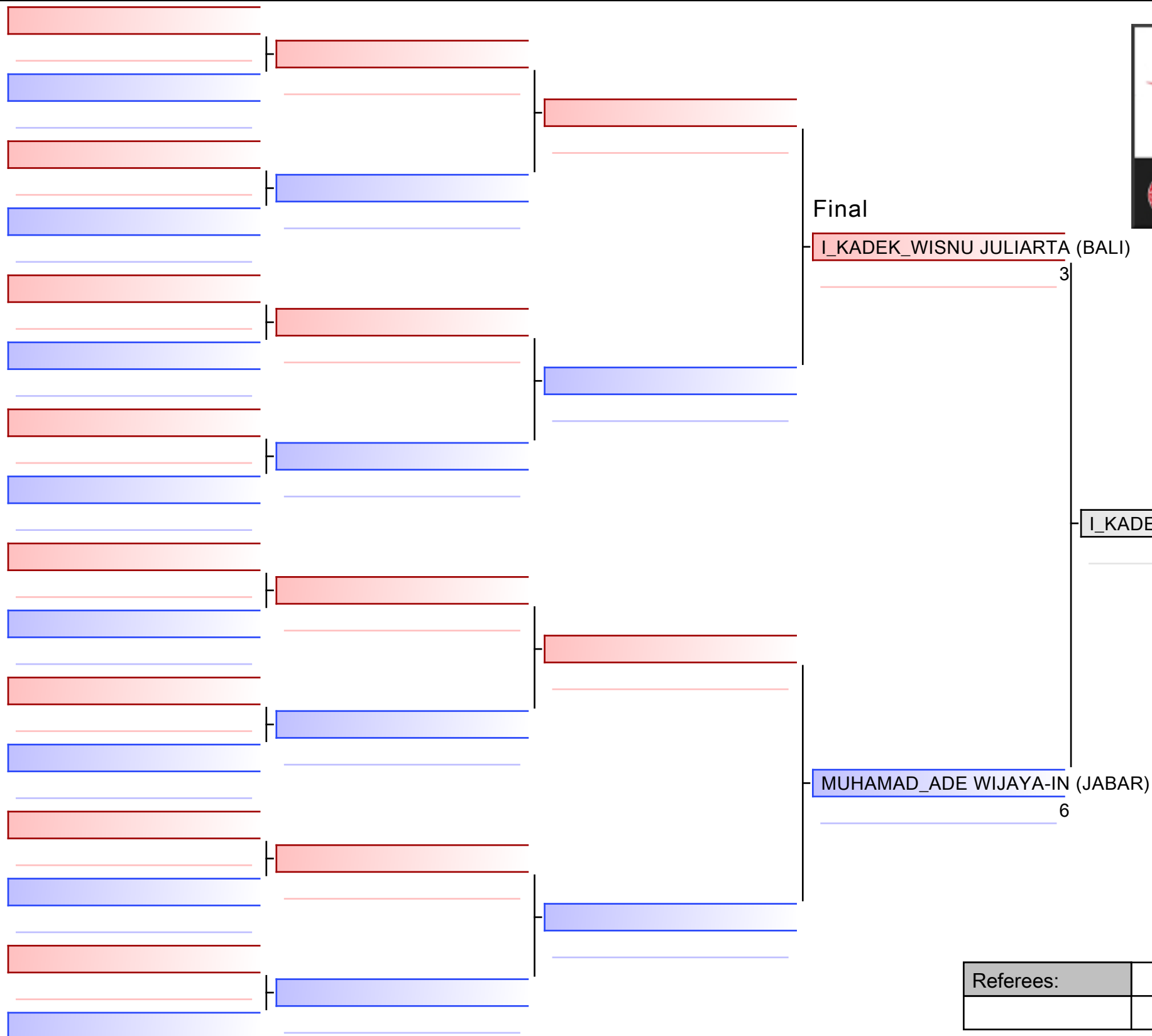

- | |
|---|
| 1. I_KADEK_WISNU JULIARTA (BALI) |
| 2. MUHAMAD_ADE WIJAYA-IN (JABAR) |
| 3. RACKEE BALARAMA_IN (JATENG) |
| 3. WINTAMA_DIMAS FIQIH-KI (LAMPUNG) |
| 5. MUHAMMAD_AFZAN ZIDANI-IS (RIAU) |
| 5. EXELINDO GRANDIS_PELUPESSY_IN (SULTEN) |
| 7. MUHAMMAD_DZAKA HIBATULLA (LEMKARI) |
| 7. MUHAMMAD_ATHAILLAH AL_CHARIM (GOJUKA) |

Referees:			

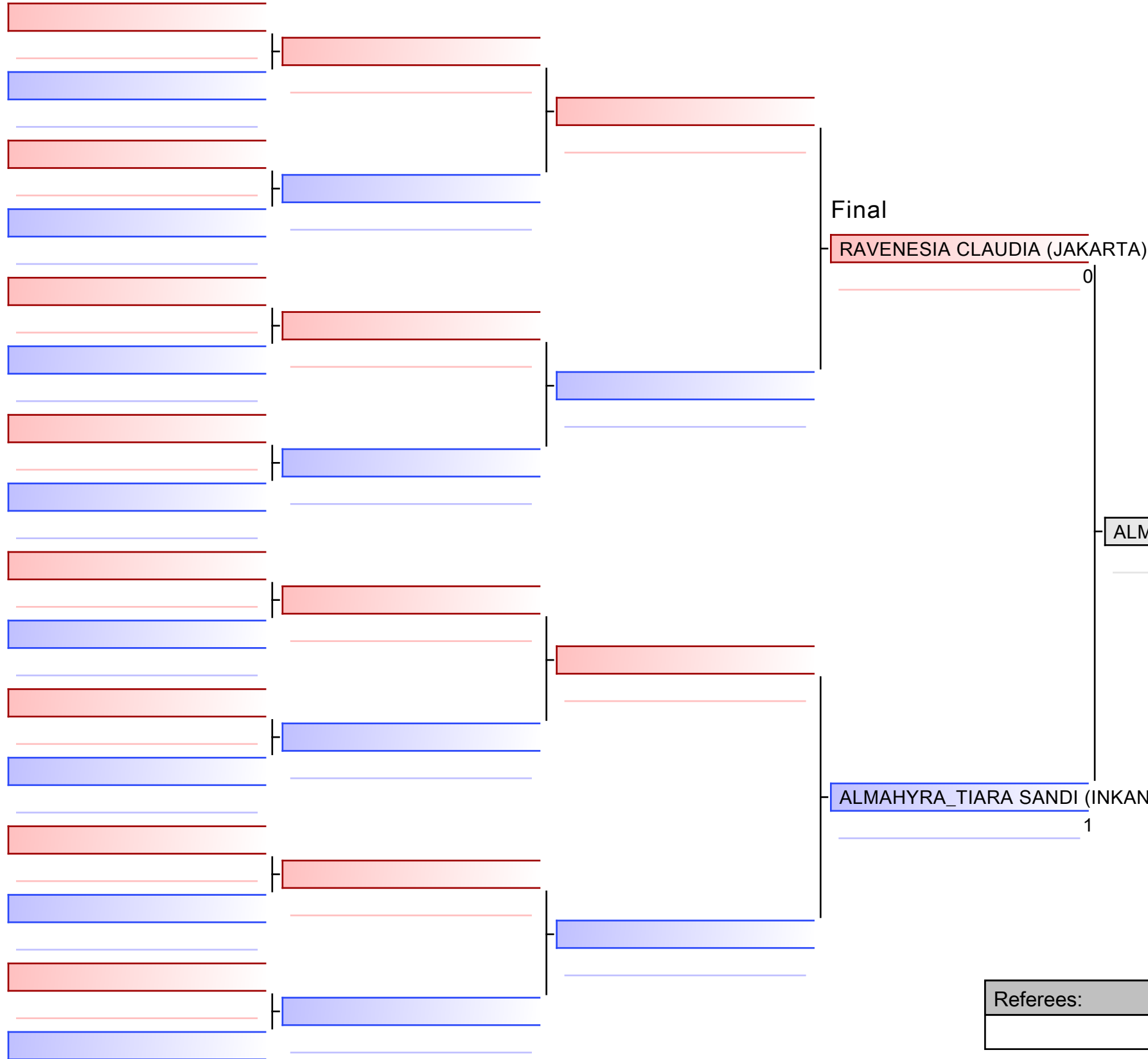

- | |
|--|
| 1. ALMAHYRA_TIARA SANDI (INKANAS) |
| 2. RAVENESIA CLAUDIA (JAKARTA) |
| 3. SYAIRA_AFSARIN GUSTIAN-KI (LAMPUNG) |
| 3. GRAISELLA_HELENA TARANDUNG (SULUT) |
| 5. NAFAHATIN FADILLAH_A (LEMKARI) |
| 5. SALMA AULIA_ (INKAI) |
| 7. PASKA_ROMAULI SIANIPAR (KEISHINKAN) |
| 7. NABILA PUSPA_WK (JATENG) |

Referees:			

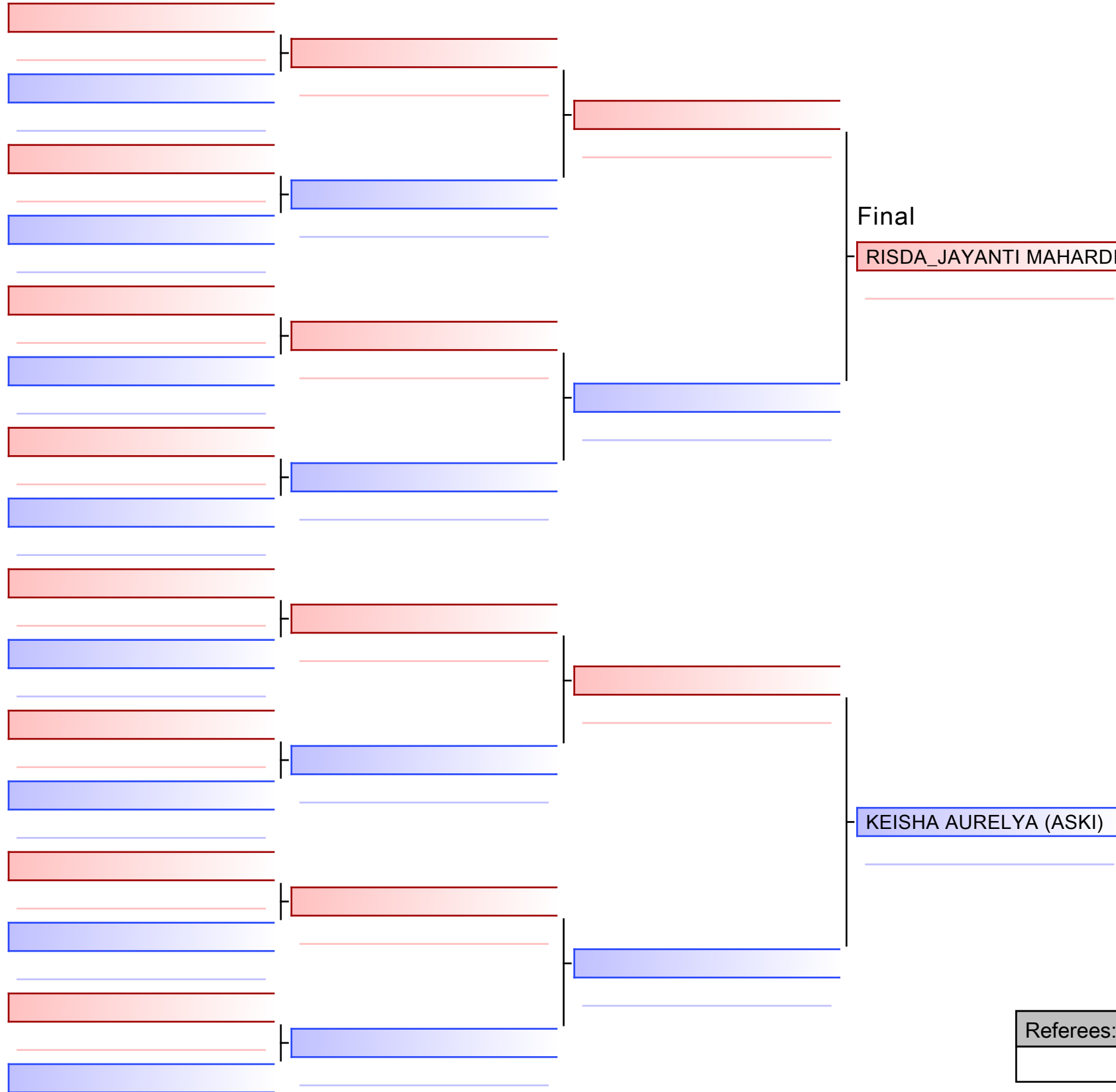

Final

RISDA_JAYANTI MAHARDIKA-IN (JABAR)

3

RISDA_JAYANTI MAHARDIKA-IN (JABAR)

KEISHA AURELYA (ASKI)

1

- | |
|---|
| 1. RISDA_JAYANTI MAHARDIKA-IN (JABAR) |
| 2. KEISHA AURELYA (ASKI) |
| 3. CAROLLIN CASEYPRILIA_IN (JATENG) |
| 3. PRIEL_RENATA_YOSINA HIDOM (INKADO) |
| 5. NURUL_SANDIKA MAUDI-IN (KALTIM) |
| 5. IDA_AYU_MIRAH PRAMISWARI_PUTRI_TENAY |
| 7. NOVI YANTI_SAPITRI_LK (RIAU) |
| 7. NAURAH RAUDHATUL_JANNAH_WK (SUMSEL) |

Referees:			

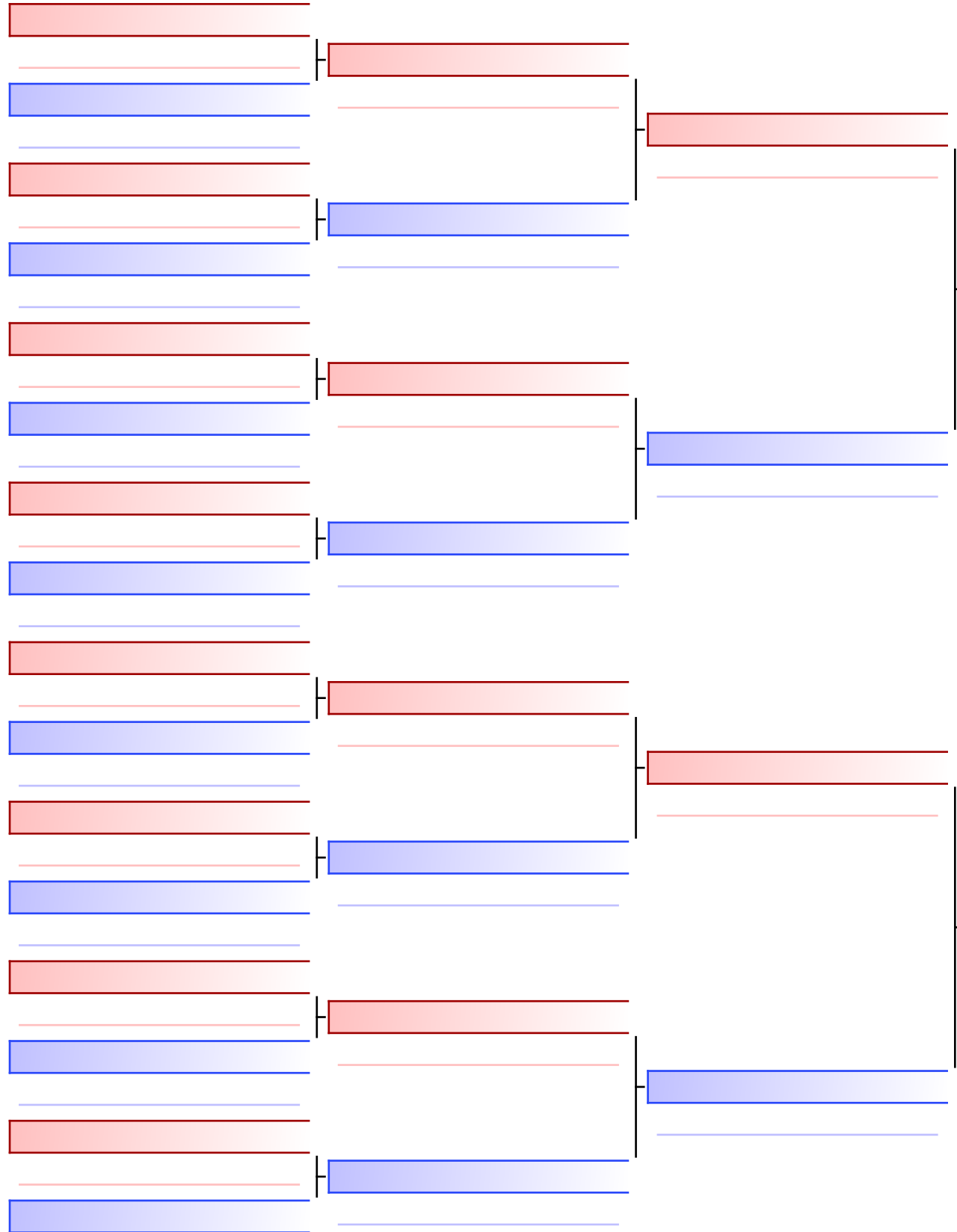

Final

IMMANIAR_ANGELA_SUDARNO PUTRI (INKAI)

1

LUVENA MILANO_SETIYAKO_IN (JATENG)

LUVENA MILANO_SETIYAKO_IN (JATENG)

3

- | |
|--|
| 1. LUVENA MILANO_SETIYAKO_IN (JATENG) |
| 2. IMMANIAR_ANGELA_SUDARNO PUTRI (INKAI) |
| 3. ARDIANI_SITI FADILLA (SUMUT) |
| 3. DELA LUTFIA (LEMKARI) |
| 5. ERINE_BRYTHANIA_AURORA POTOROLI (SUL) |
| 5. NINDYA KIRANA (ASKI) |
| 7. NABILA_ZHULFA LAILA (WADOKAI) |
| 7. SYFA_HANIDAH SALSA_DILA_IS (SULTENG) |

Referees:			

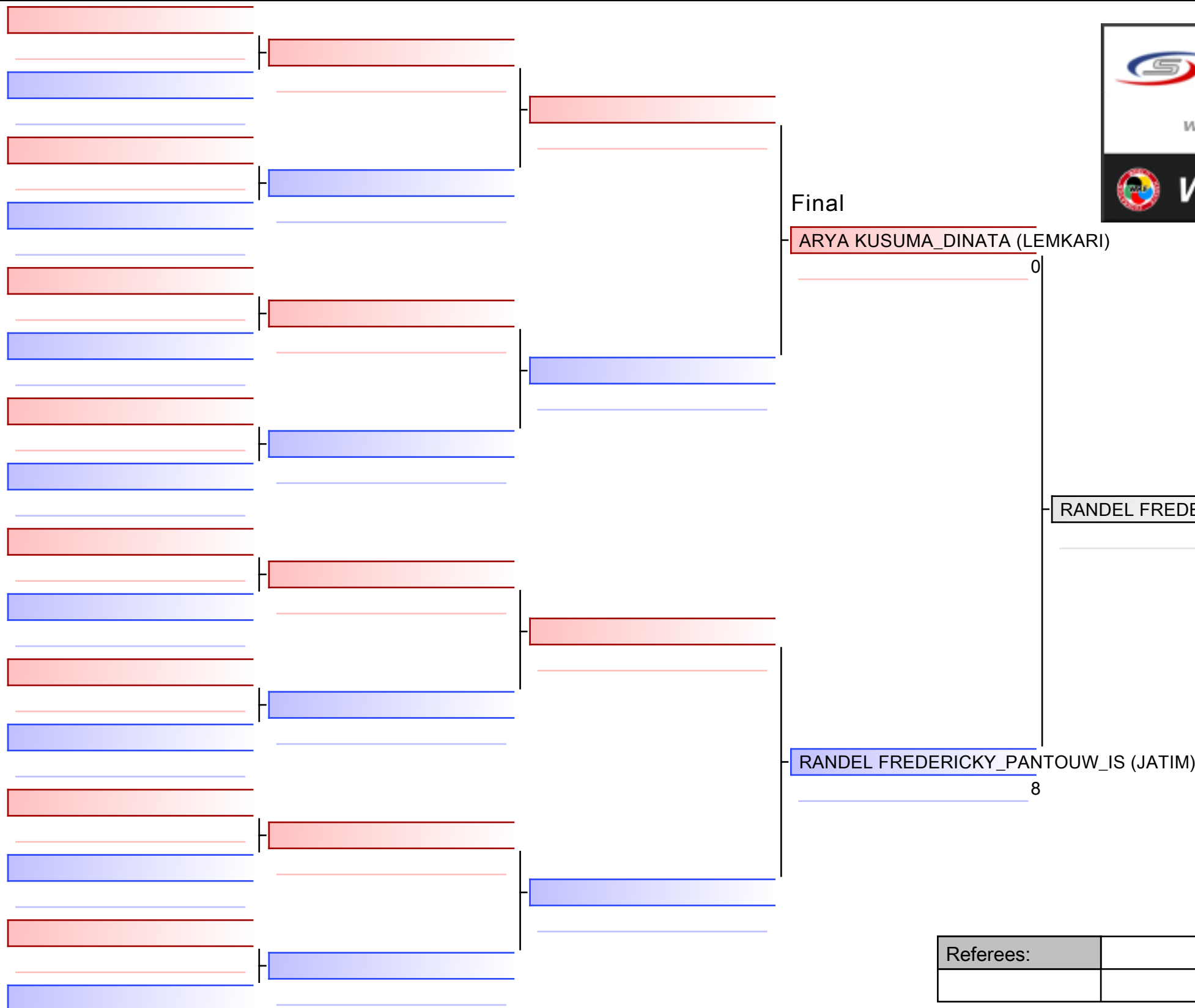

- | |
|---|
| 1. RANDEL FREDERICKY_PANTOUW_IS (JATIM) |
| 2. ARYA KUSUMA_DINATA (LEMKARI) |
| 3. PRAYOGA_DWI CAHYONO (BABEL) |
| 3. RINALDY RAMADIA (JAKARTA) |
| 5. MIFTAH_FAUZAN TANDJUNGBULU (INKANAS) |
| 5. ILHAM_YADI SYAM (BKC) |
| 7. JIMMY ADITYA_AKBAR_IN (NTB) |
| 7. ANDI_RAFLI RANDI (INKADO) |

Referees:			

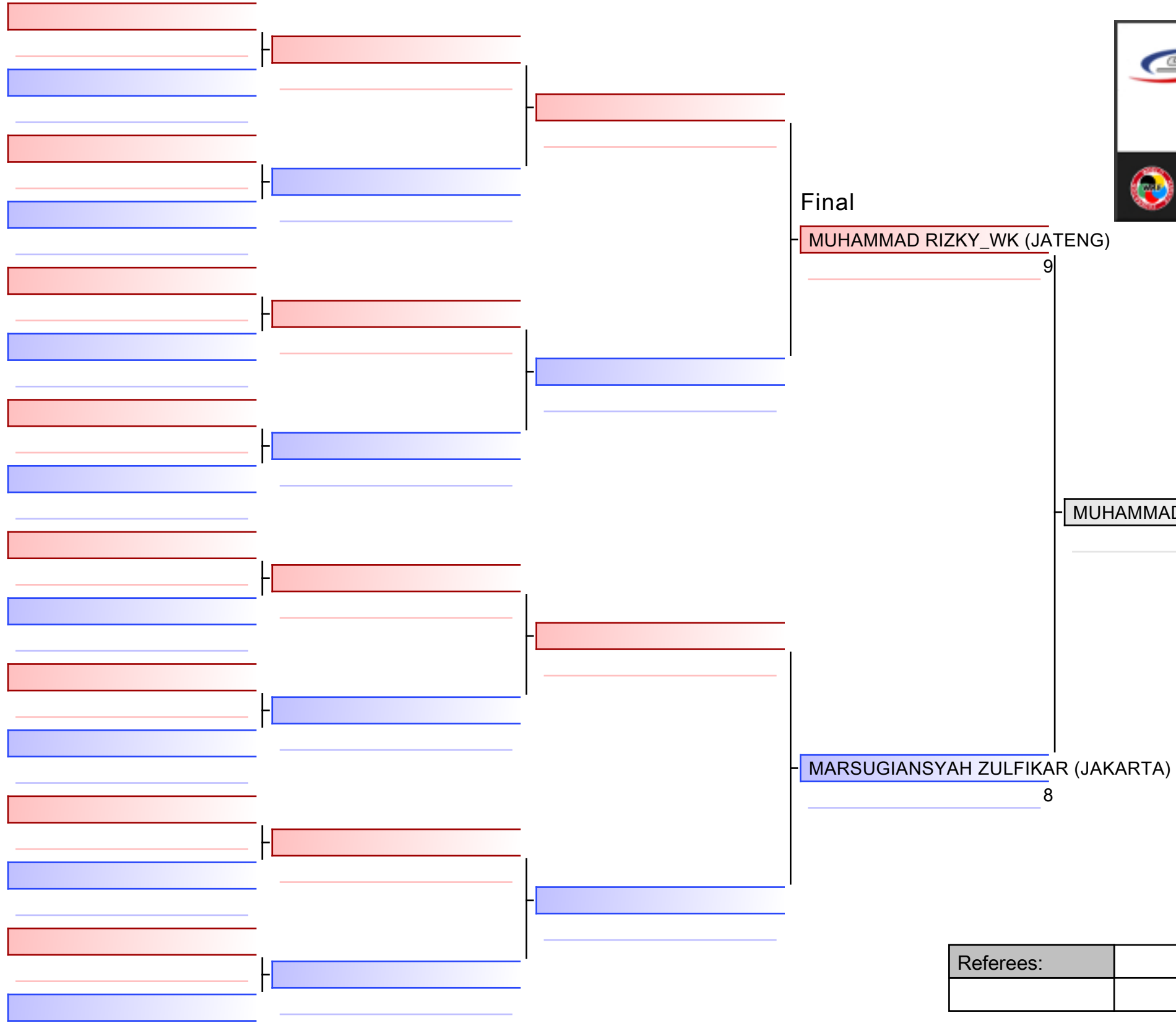

MUHAMMAD RIZKY_WK (JATENG)

MUHAMMAD RIZKY_WK (JATENG)

9

MARSUGIANSYAH ZULFIKAR (JAKARTA)

8

- | |
|-------------------------------------|
| 1. MUHAMMAD RIZKY_WK (JATENG) |
| 2. MARSUGIANSYAH ZULFIKAR (JAKARTA) |
| 3. FRANSISCUS_FINA SAUNOA (INKAI) |
| 3. GRAIN_MAESA TAMPI (SULUT) |
| 5. M_ARDHIAT SYAM (SULSEL) |
| 5. I_PUTU_SACKLI EKA_NATA (BALI) |
| 7. MUHAMMAD_FAJRUL MANA (NTB) |
| 7. RIDHO HUTAPEA (TAKO) |

Referees:			

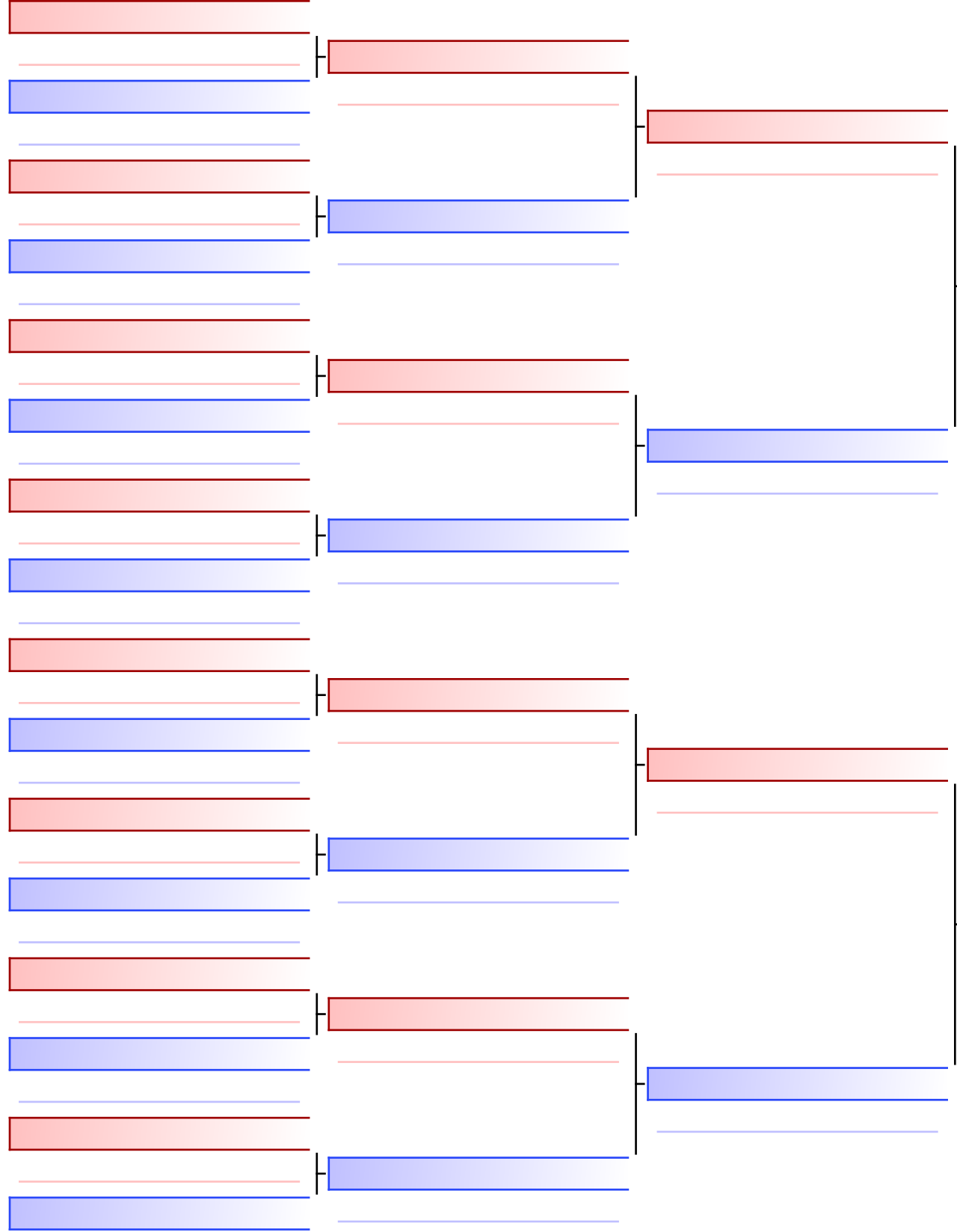

Final

I_KOMANG_BAGUS SURYADANA (BALI)

2

ALFIANO_ADI RISTIAWAN (INKANAS)

ALFIANO_ADI RISTIAWAN (INKANAS)

10

- | |
|---|
| 1. ALFIANO_ADI RISTIAWAN (INKANAS) |
| 2. I_KOMANG_BAGUS SURYADANA (BALI) |
| 3. BRILLIAN OGI (INKAI) |
| 3. IMMANUEL_HEPRIANTO SIMANJUNTAK_KI (SU) |
| 5. M_RISKY ROMADHONI-IN (JATIM) |
| 5. MUHAMMAD_GHAZY AL_GHIFARI (SHOKAIDO) |
| 7. ANGGA PRATAMA_ID (SULSEL) |
| 7. ANDRIANTO SINAGA (WADOKAI) |

Referees:			

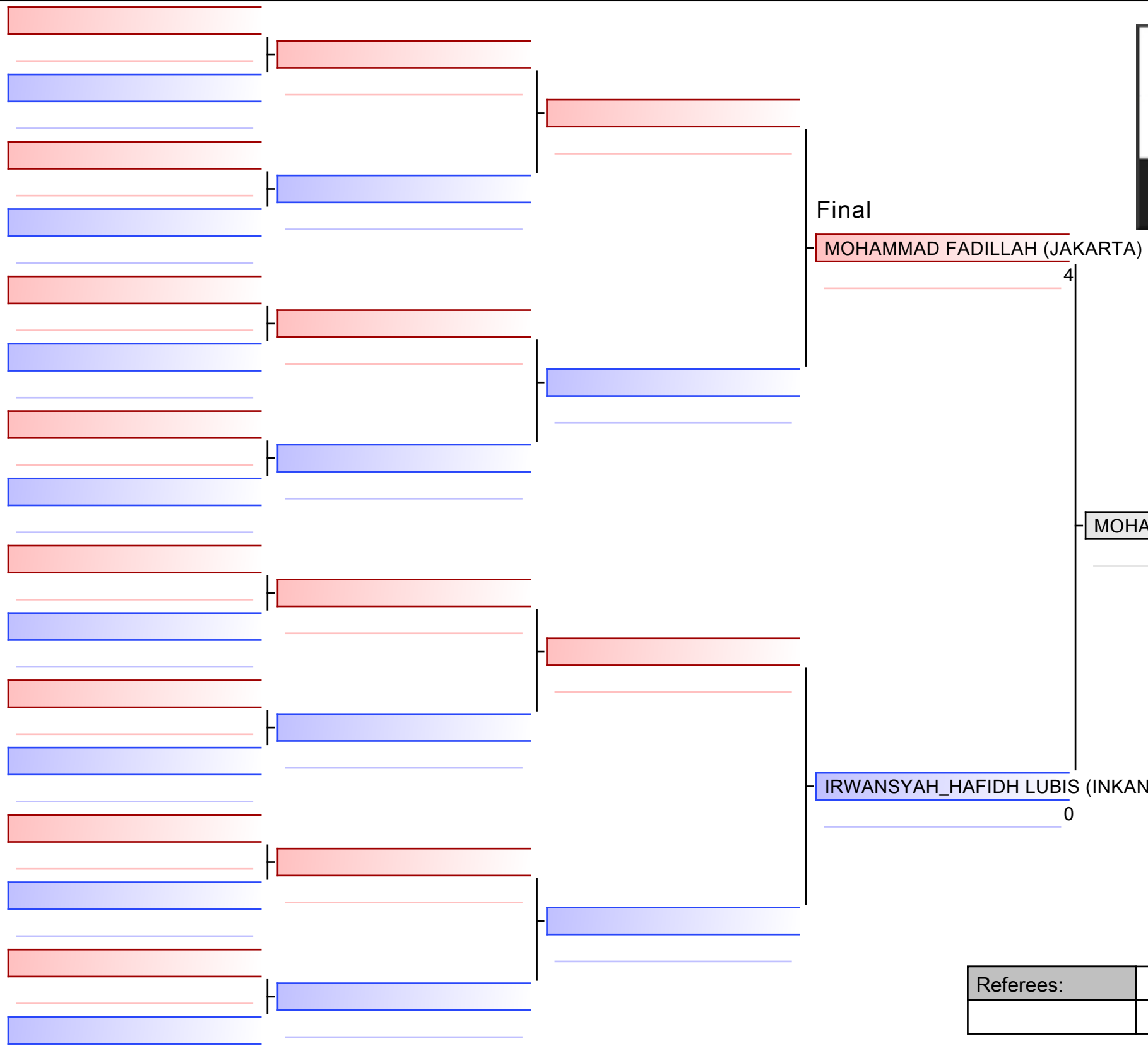

MOHAMMAD FADILLAH (JAKARTA)

- 1. MOHAMMAD FADILLAH (JAKARTA)
- 2. IRWANSYAH_HAFIDH LUBIS (INKANAS)
- 3. RISKIANDO_CHARLOS RIHULAY_IN (MALUKU)
- 3. DUSKY MUBARAQ (TAKO)
- 5. MOCHAMAD ZHIDAN_IS (JABAR)
- 5. I_GUSTI_PUTU NGURAH_WIDIWAN (BALI)
- 7. MUHAMMAD_TEGUH PEBRIAN (BKC)
- 7. WIRA_SURYA ADESAPUTRA_IN (SULSEL)

Referees:			



ANNISA_NUR ANGGRAENI (JAKARTA)

- | |
|-----------------------------------|
| 1. ANNISA_NUR ANGGRAENI (JAKARTA) |
| 2. ABDIRA NADIRASI-IS (NTB) |
| 3. FARADILA ADAM_IS (GORONTALO) |
| 3. FIQRA_DWI SASKIAH (KKI) |
| 5. ANNIDA SYADIAHRO (ASKI) |
| 5. SEKAR_DWI AYU_TYAS (LEMKARI) |
| 7. EVINA SEPTIYANI (BKC) |
| 7. MERLYANTI _BD (SULTENG) |

Referees:			

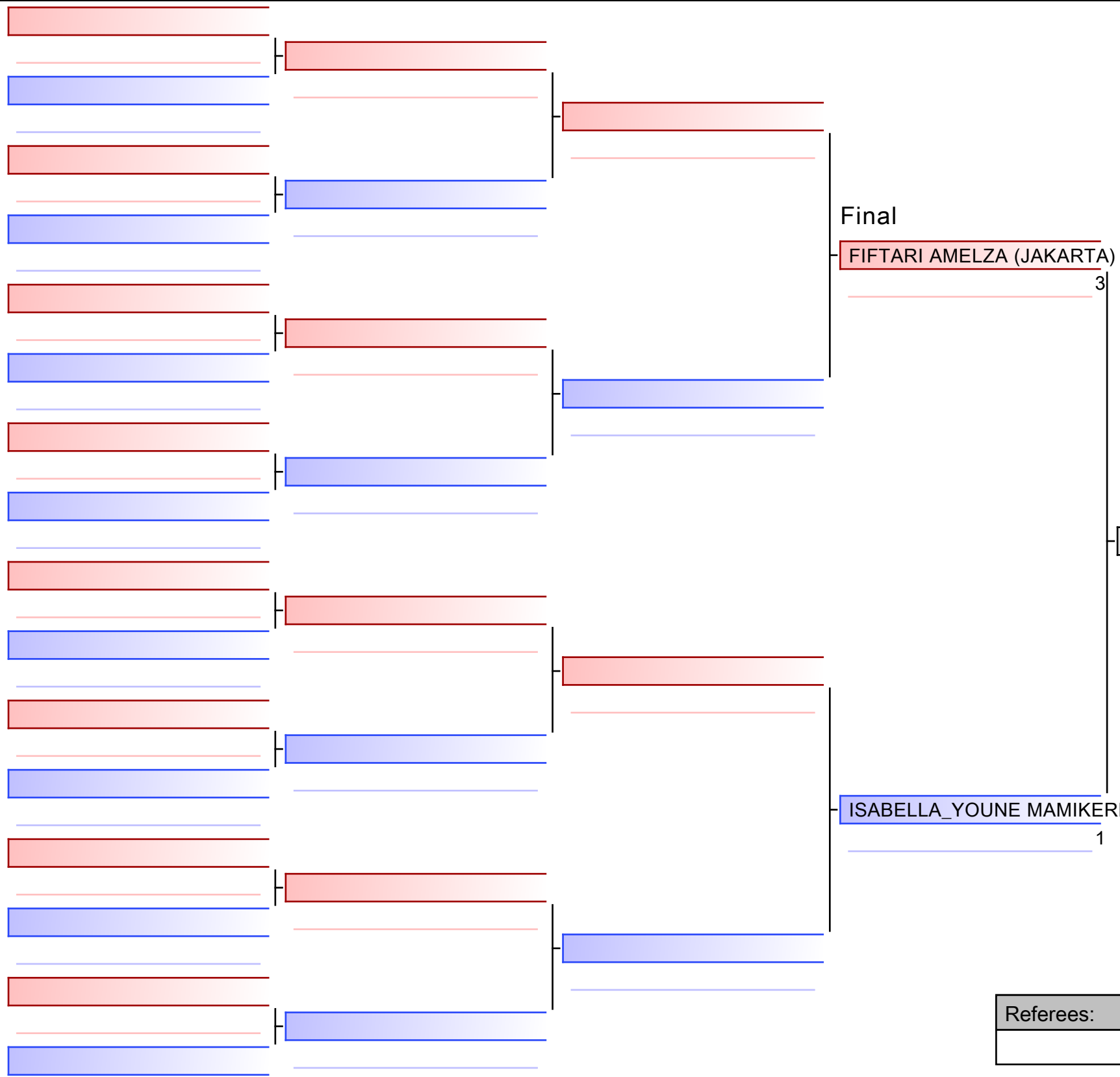

FIFTARI AMELZA (JAKARTA)

- | |
|--------------------------------------|
| 1. FIFTARI AMELZA (JAKARTA) |
| 2. ISABELLA_YOUNE MAMIKERE (INKANAS) |
| 3. ANGURI_NASYWA PRASISTA-IN (JATIM) |
| 3. SANIA - (KKI) |
| 5. NABELA ZAIDAH (INKAI) |
| 5. MARINI_SELOMITA LERAH (SULUT) |
| 7. CHAVELLA TEYZA_WK (JATENG) |
| 7. APRILIANI ELSIE-KI (KALTIM) |

Referees:			

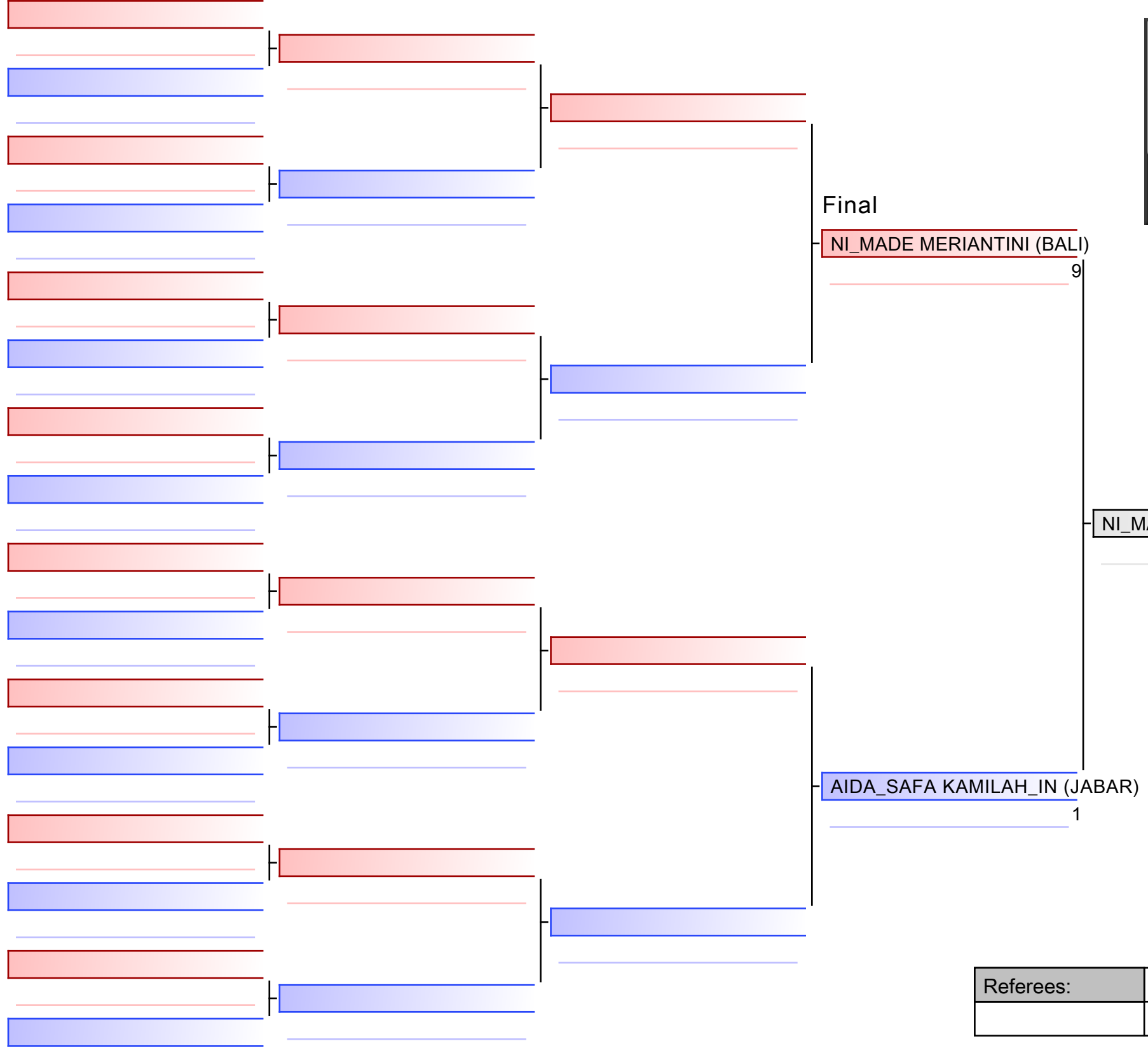

NI_MADE MERIANTINI (BALI)

- | |
|--------------------------------------|
| 1. NI_MADE MERIANTINI (BALI) |
| 2. AIDA_SAFa KAMILAH_IN (JABAR) |
| 3. THERESIA DEVINA (KKI) |
| 3. PANGEST_ANANDA MAHANANII-AS (DIY) |
| 5. ARGYA_DAMA NARARYA (ASKI) |
| 5. ANNISA SYATRA (NTB) |
| 7. NUR_KHOFIFAH HARAHAP_TK (SUMBAR) |
| 7. AMELIA AMANDA (INKAI) |

Referees:			

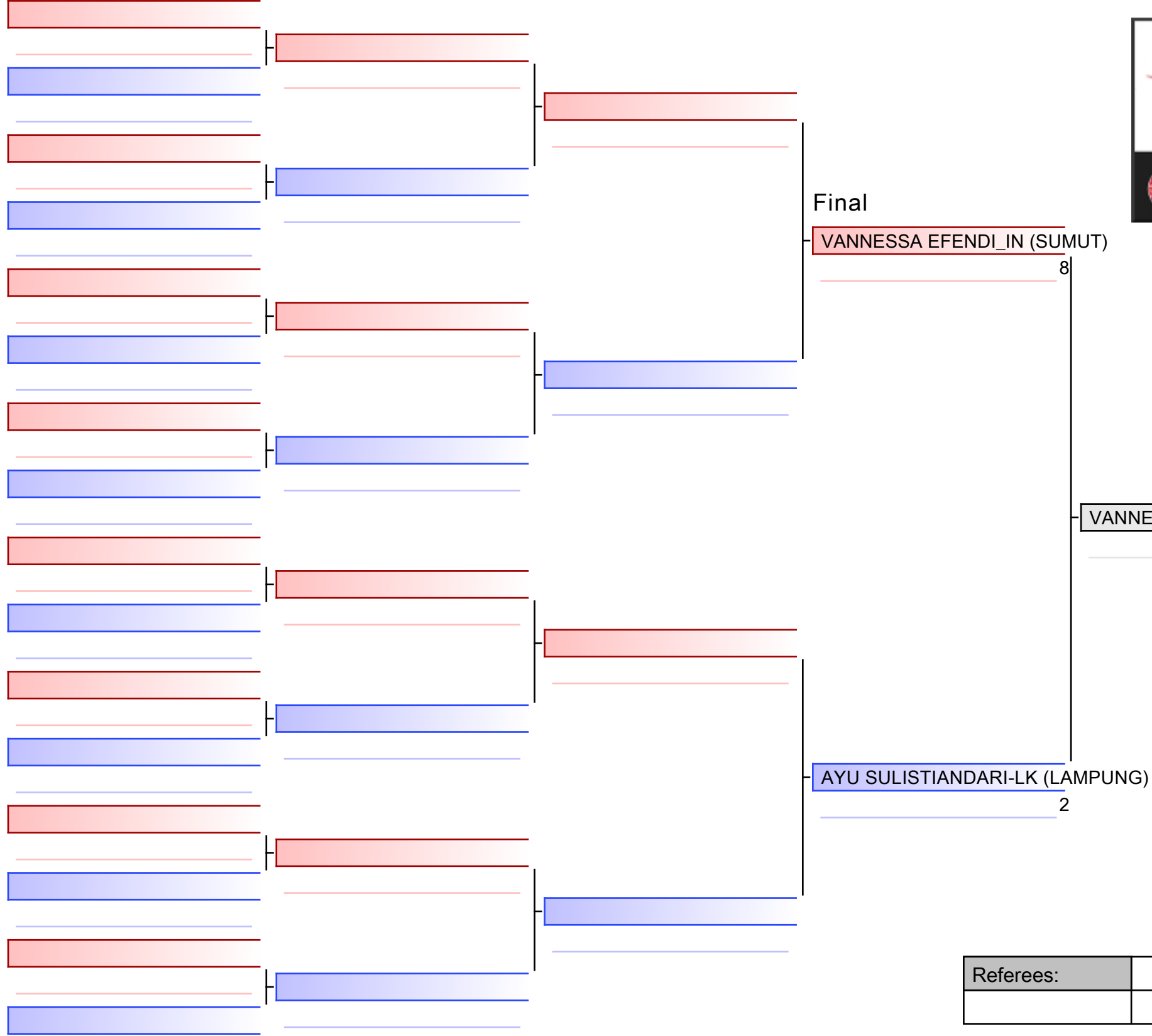

VANNESSA EFENDI_IN (SUMUT)

- | |
|-------------------------------------|
| 1. VANNESSA EFENDI_IN (SUMUT) |
| 2. AYU SULISTIANDARI-LK (LAMPUNG) |
| 3. MONIKA_RESWARA K_P-SO (JATIM) |
| 3. SALSABILA_RAGIL PUTRI (INKAI) |
| 5. PUTRI_YASMIN AZ_ZAHRA-IS (JABAR) |
| 5. ADIS_BUDI UTAMI (WADOKAI) |
| 7. ANDIEN SALSABILA (KEISHINKAN) |
| 7. CHINTIA_RIZKY_EKA PUTRI (BKC) |

Referees:			

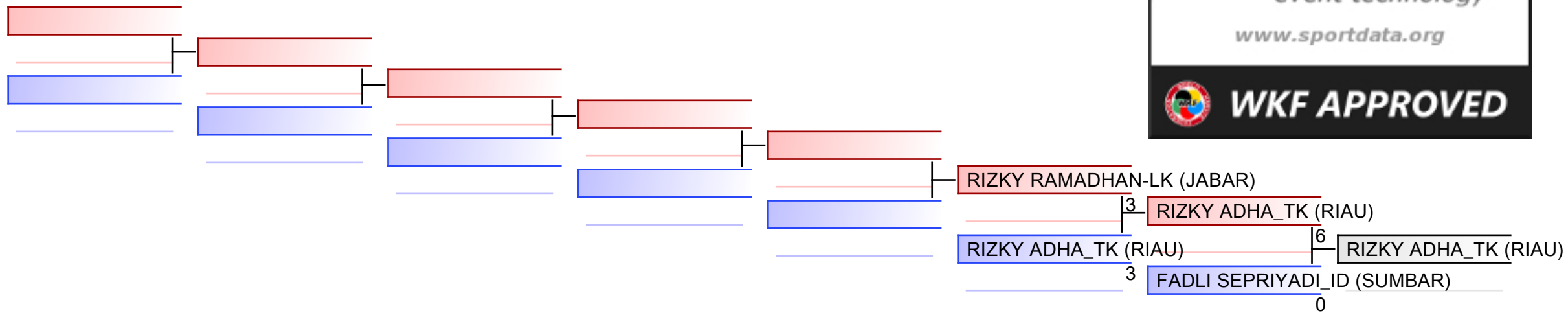

REPECHAGE: (1)

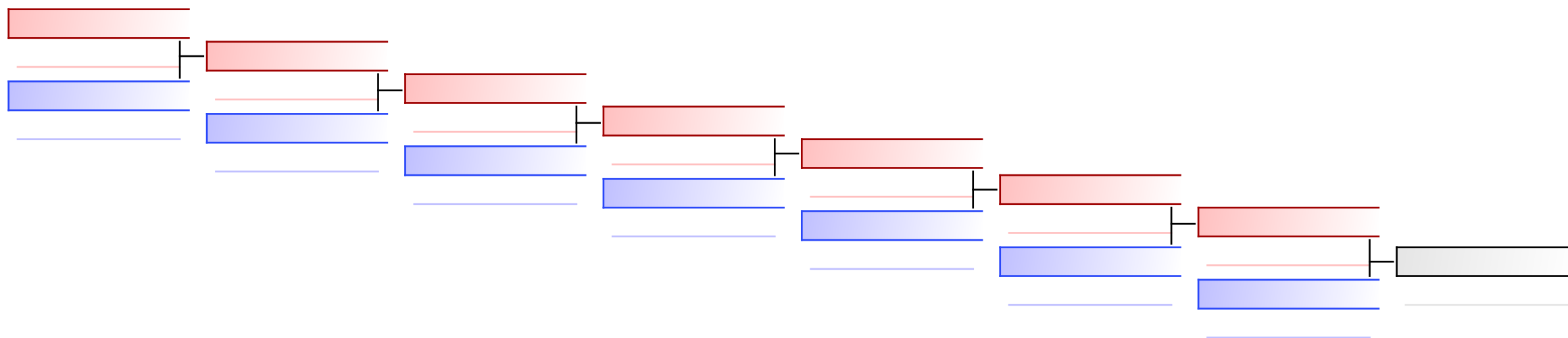

Referees:							
-----------	--	--	--	--	--	--	--

JUNIOR KUMITE PUTRA +76 KG
 KEJURNAS KARATE CADET, JUNIOR & U21 TAHUN 2021

Tatami 1 14:40
 Pool 2

(c)sportdata GmbH & Co KG 2000-2021(2021-11-08 11:11) -WKF Approved- v 9.8.8 build 1 (2021-07-19) License: Yoyo Satrio INA (expire 2022-09-03)

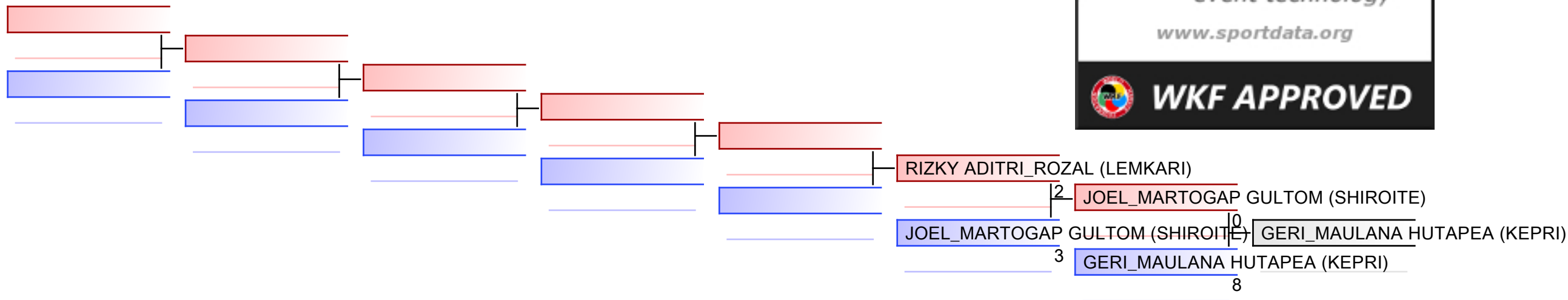

REPECHAGE: (2)

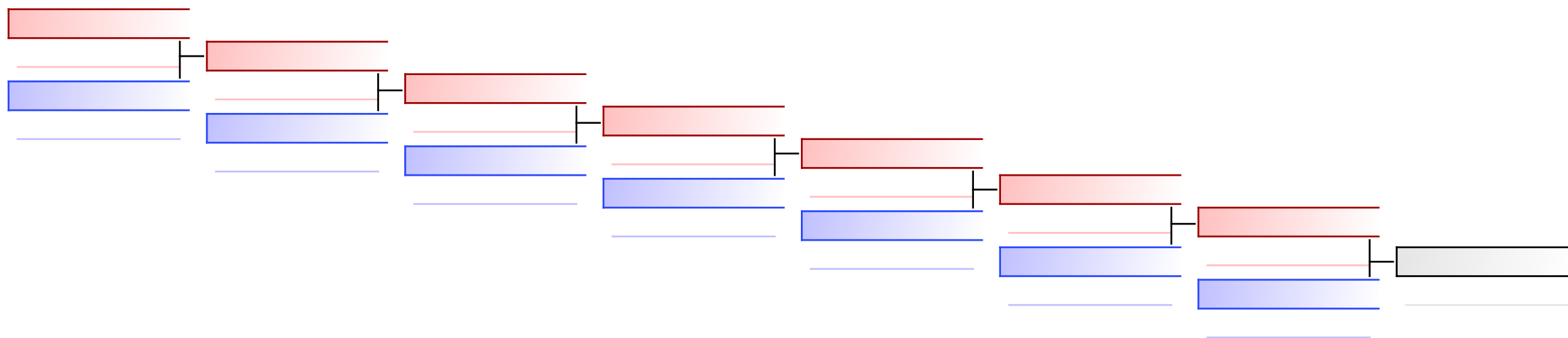

Referees:							
-----------	--	--	--	--	--	--	--

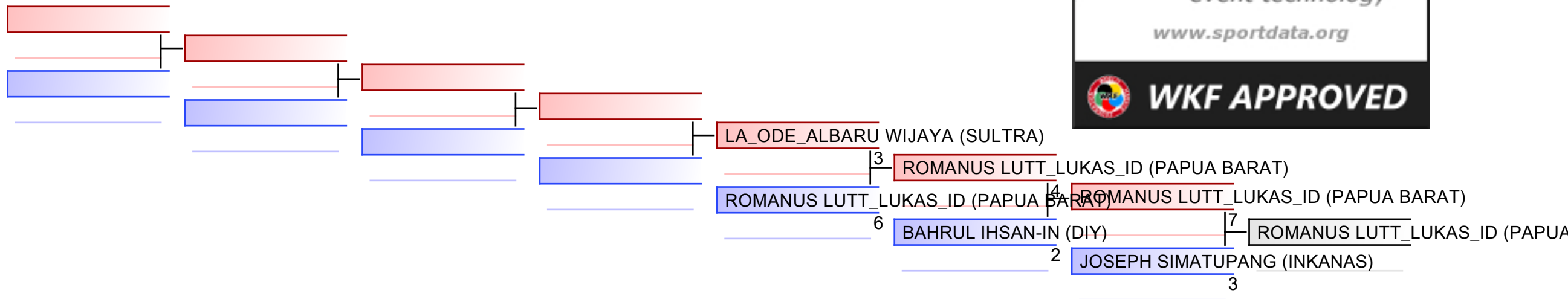

REPECHAGE: (2)

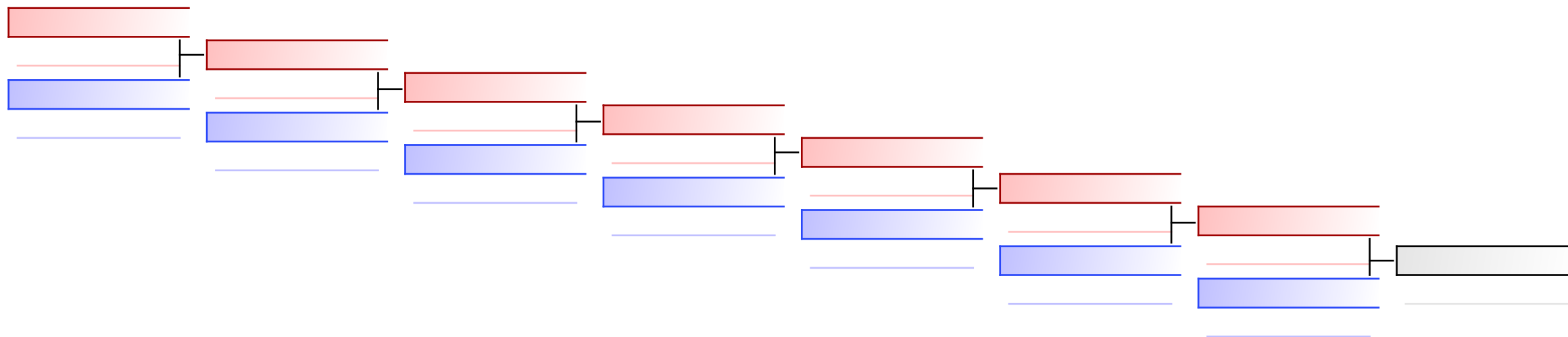

Referees:							
-----------	--	--	--	--	--	--	--

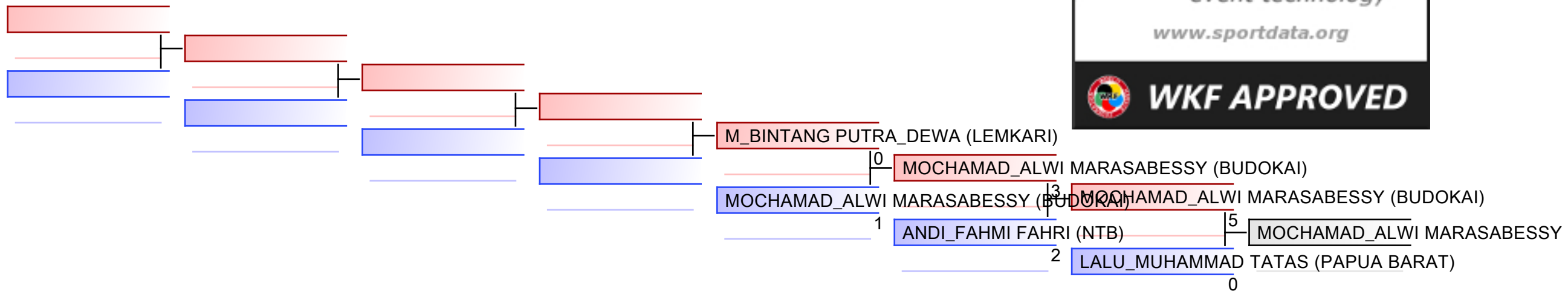

REPECHAGE: (1)

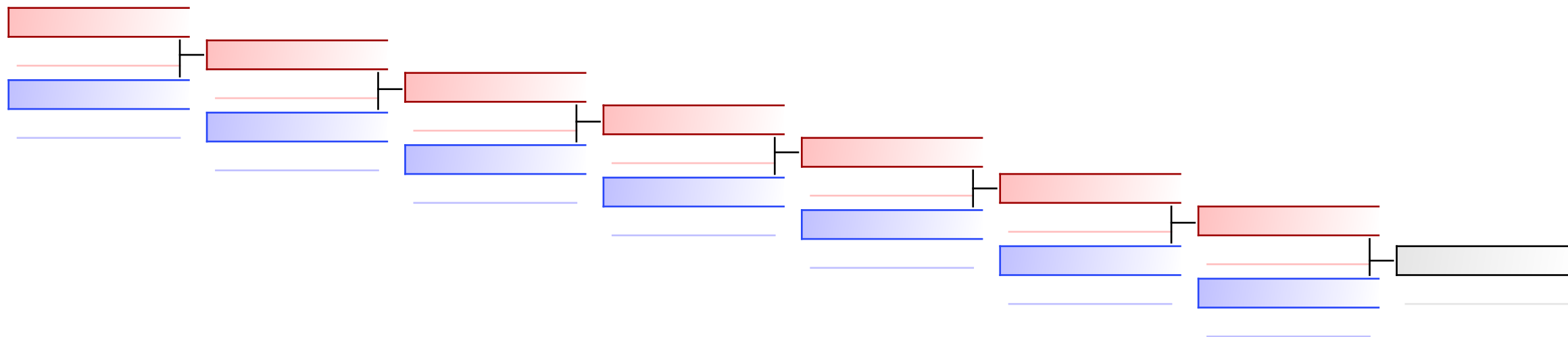

Referees:							
-----------	--	--	--	--	--	--	--

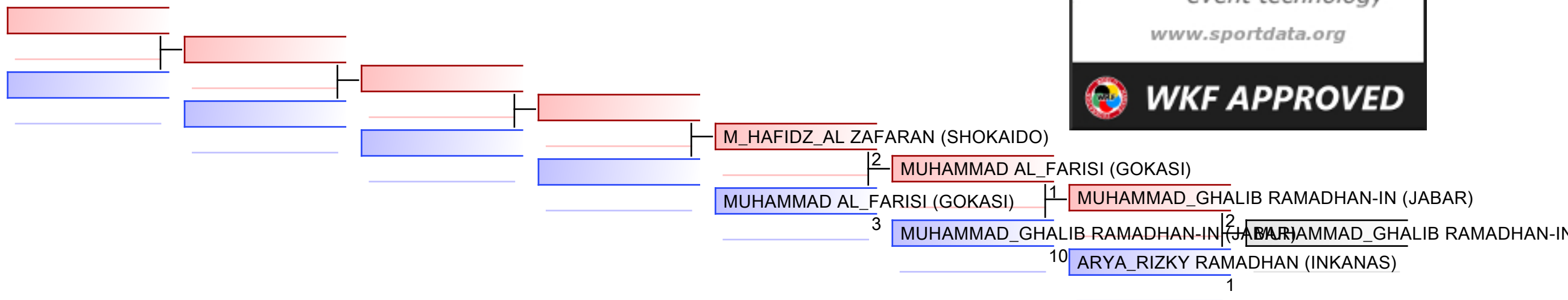

REPECHAGE: (1)

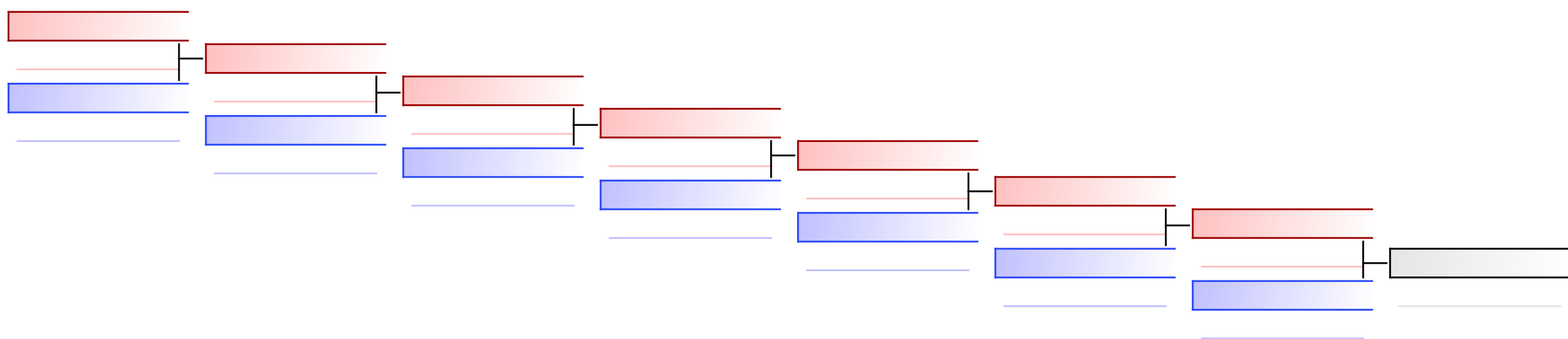

Referees:							
-----------	--	--	--	--	--	--	--

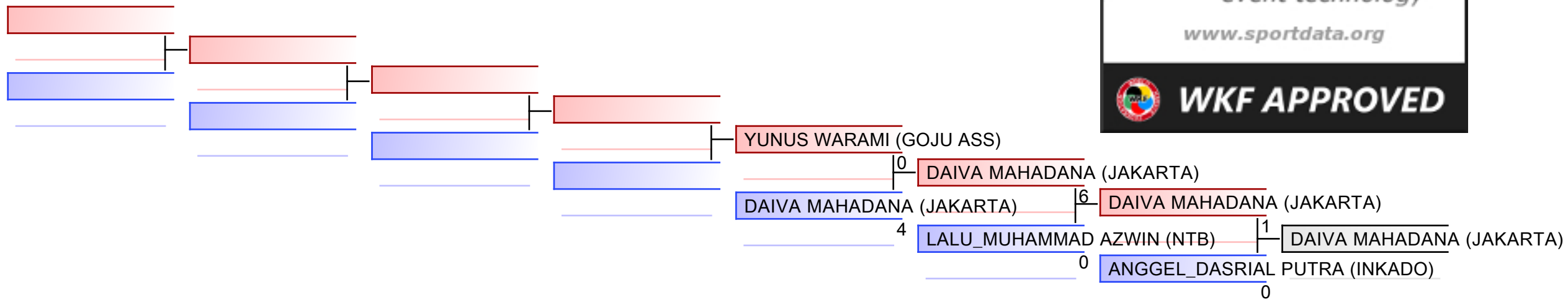

REPECHAGE: (2)

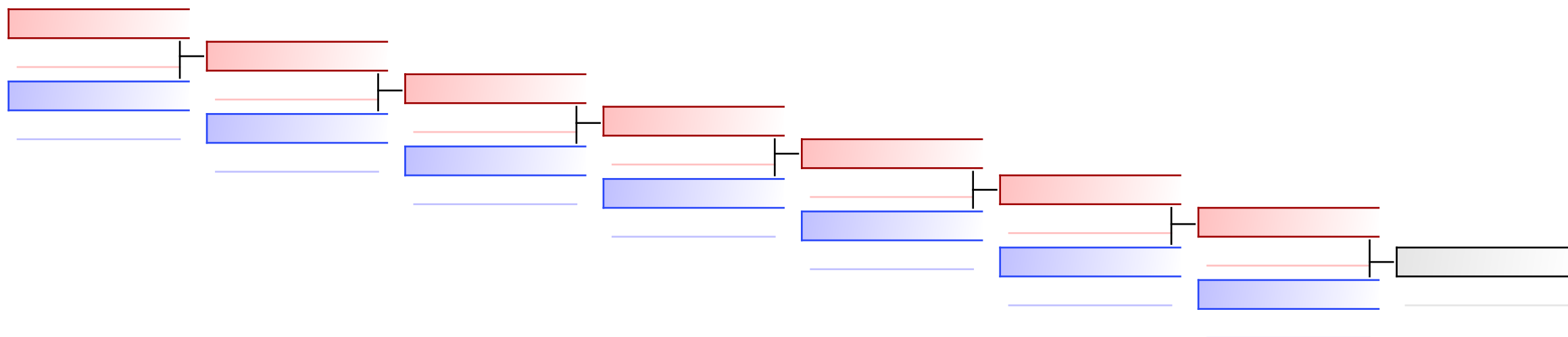

Referees:							
-----------	--	--	--	--	--	--	--

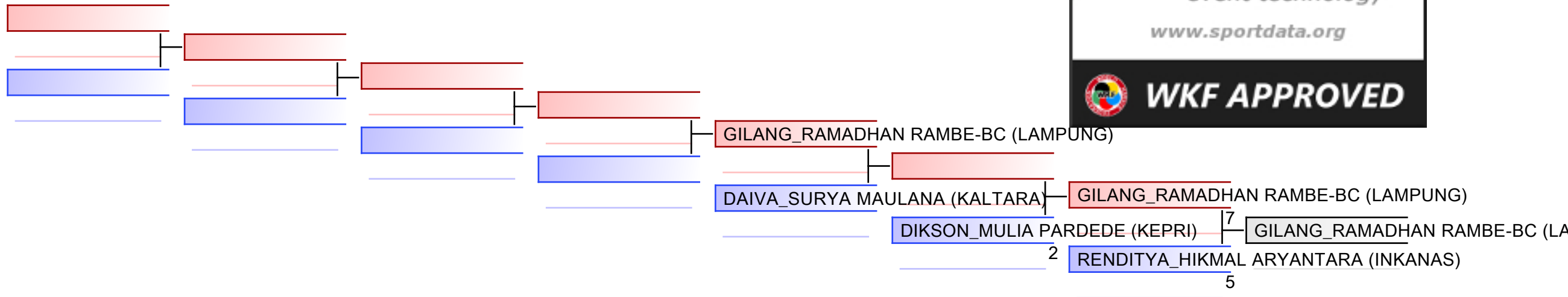

REPECHAGE: (1)

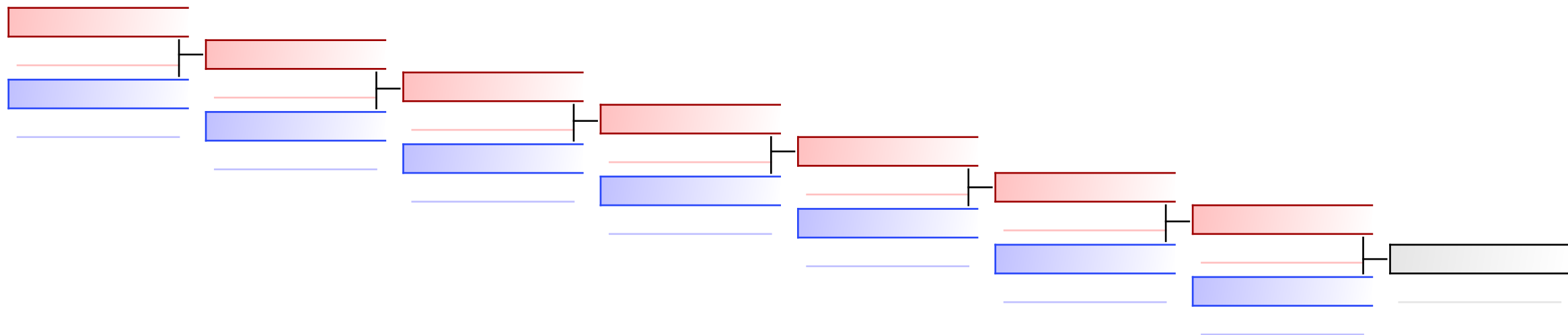

Referees:							
-----------	--	--	--	--	--	--	--

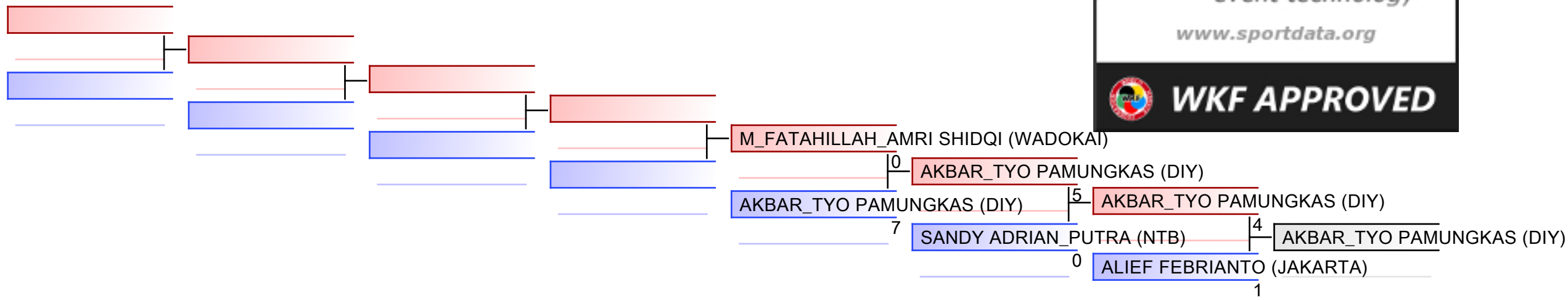

REPECHAGE: (2)

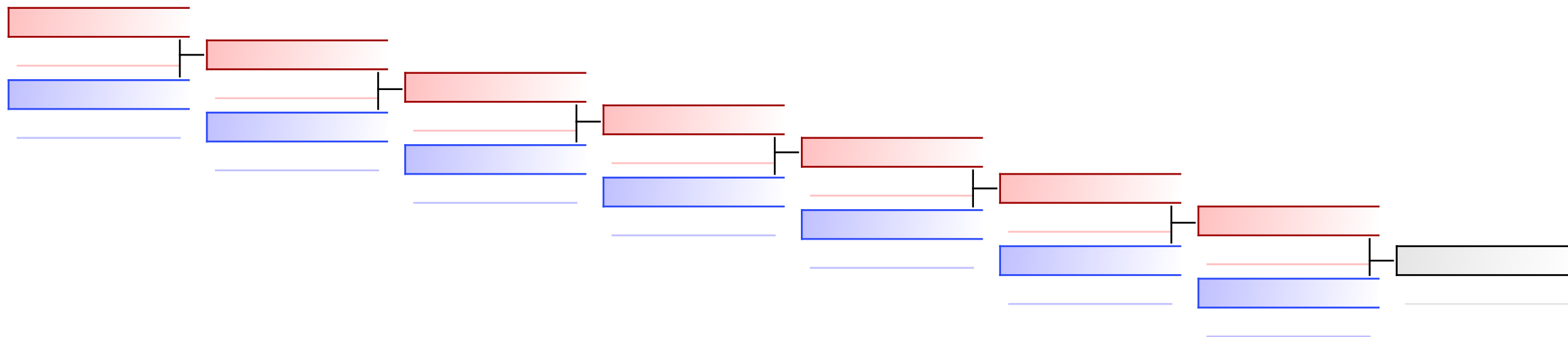

Referees:							
-----------	--	--	--	--	--	--	--

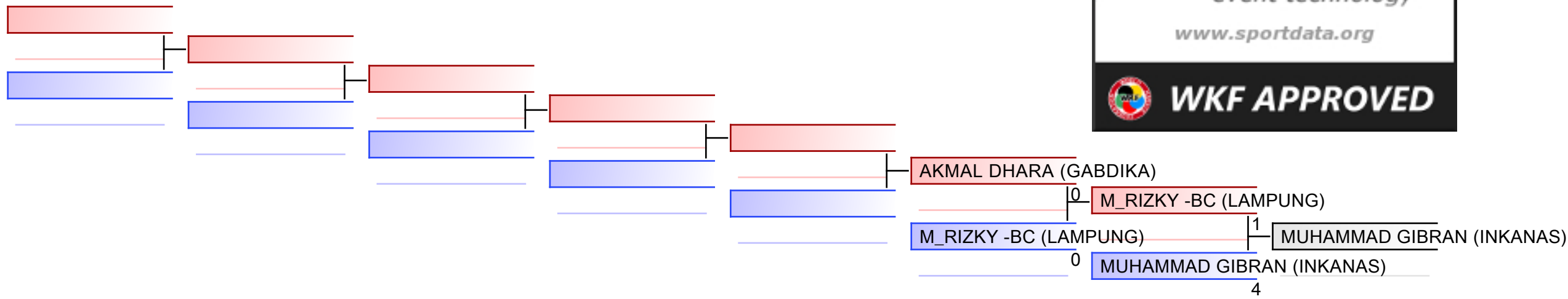

REPECHAGE: (1)

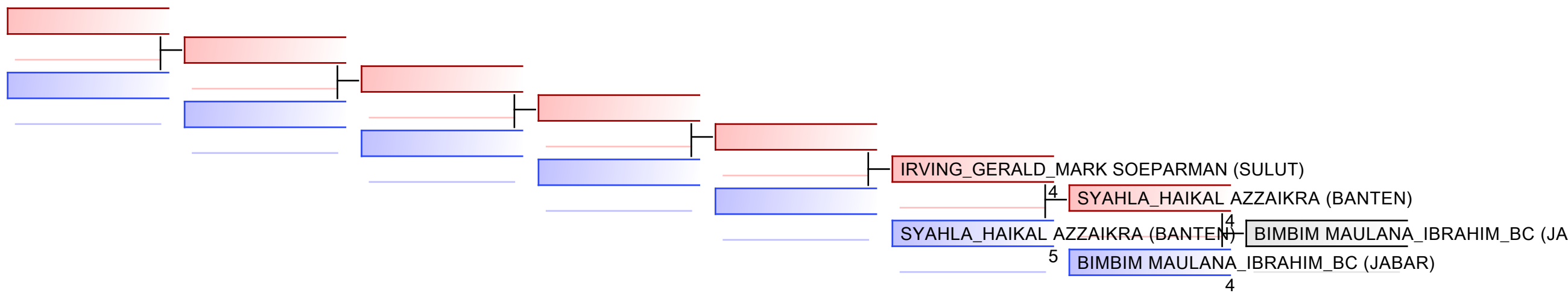

Referees:							
-----------	--	--	--	--	--	--	--

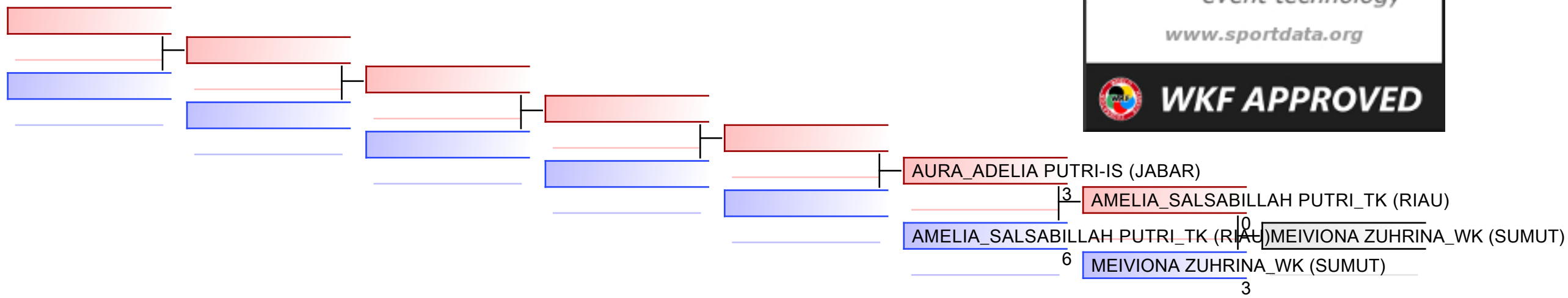

REPECHAGE: (1)

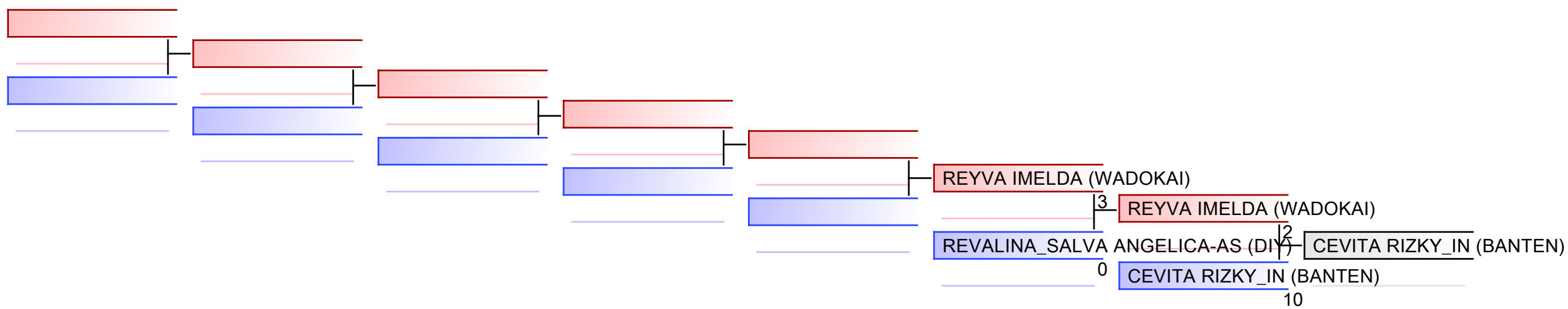

Referees:							
-----------	--	--	--	--	--	--	--

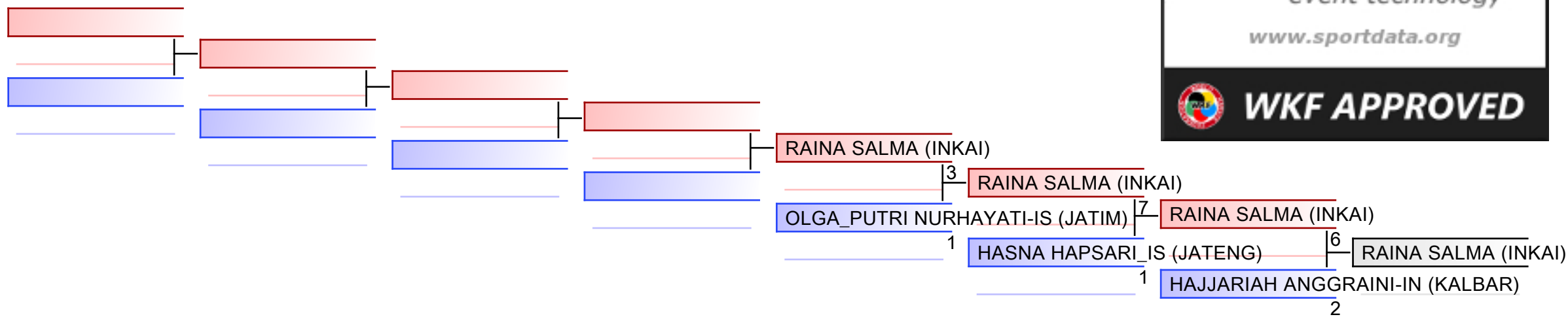

REPECHAGE: (1)

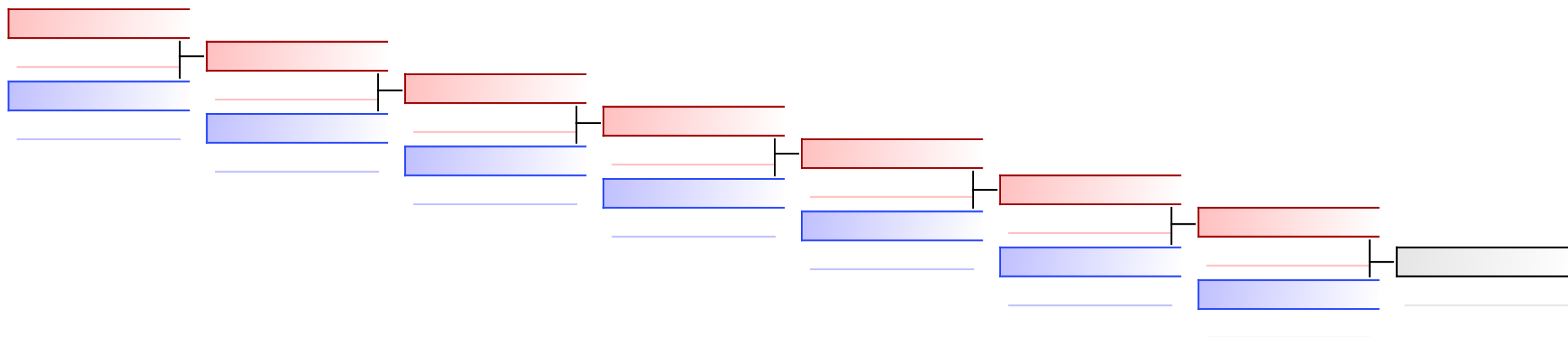

Referees:							
-----------	--	--	--	--	--	--	--

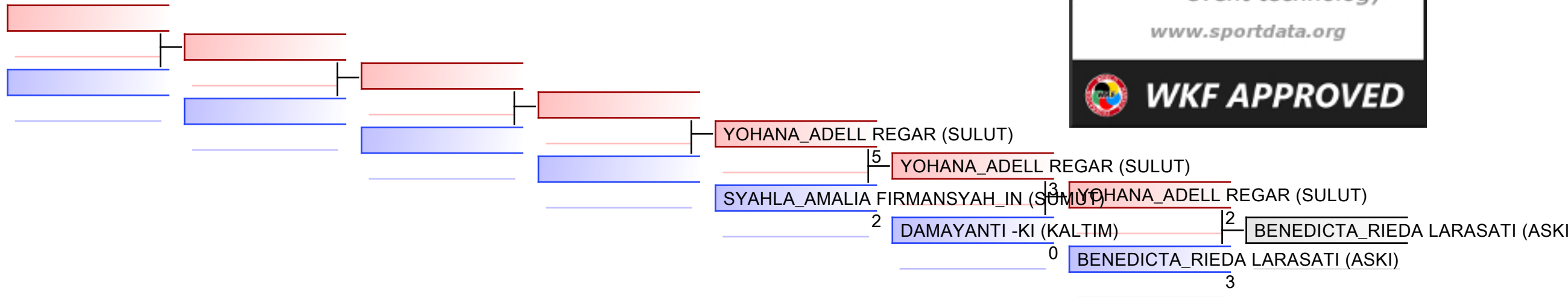

REPECHAGE: (2)

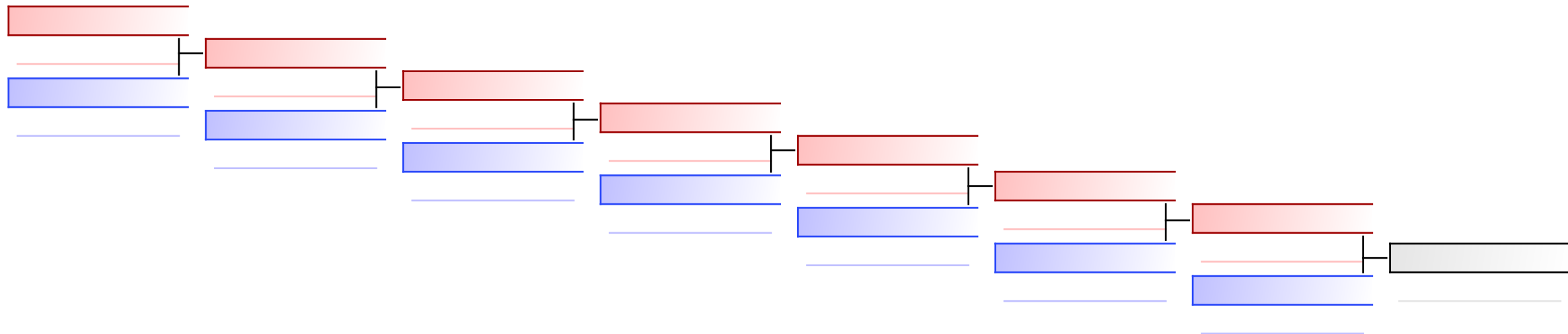

Referees:							
-----------	--	--	--	--	--	--	--

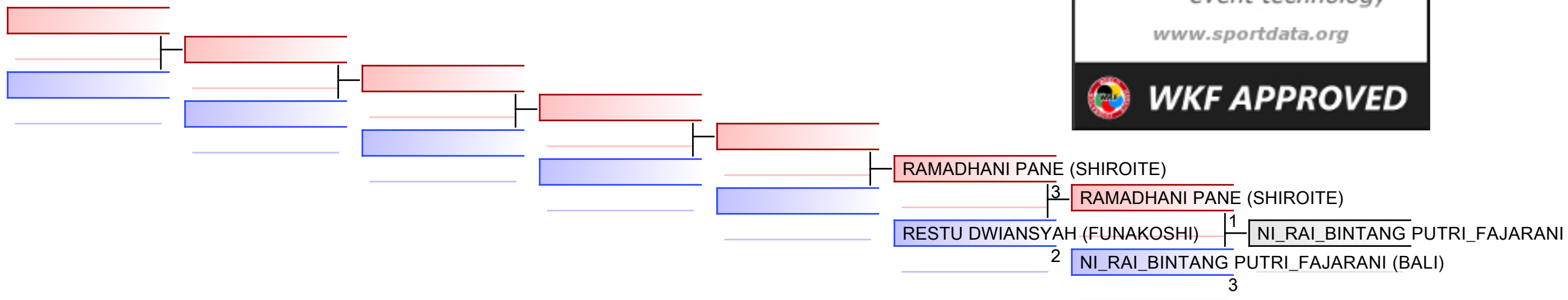

REPECHAGE: (1,2)

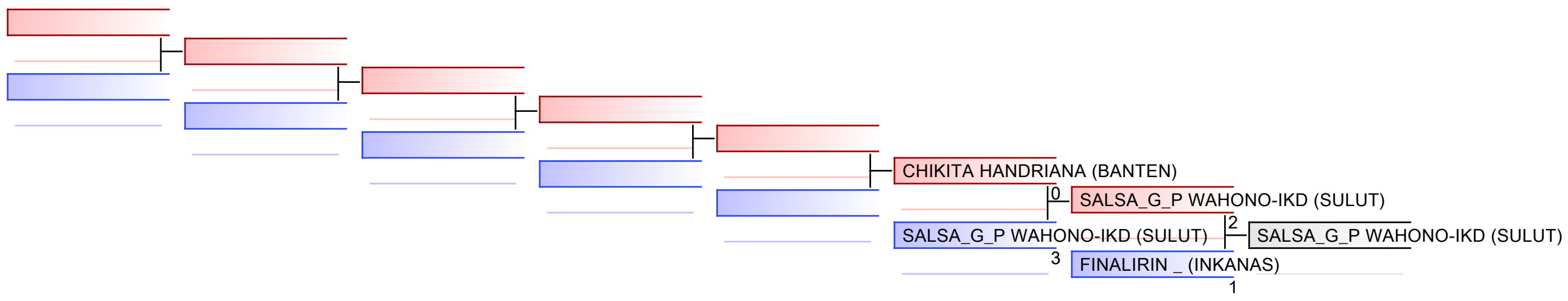

Referees:							
-----------	--	--	--	--	--	--	--

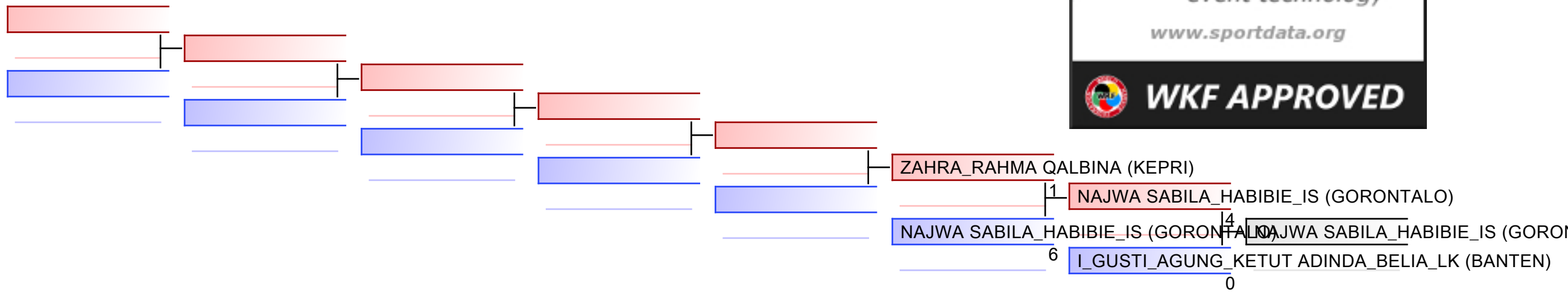

REPECHAGE: (1)

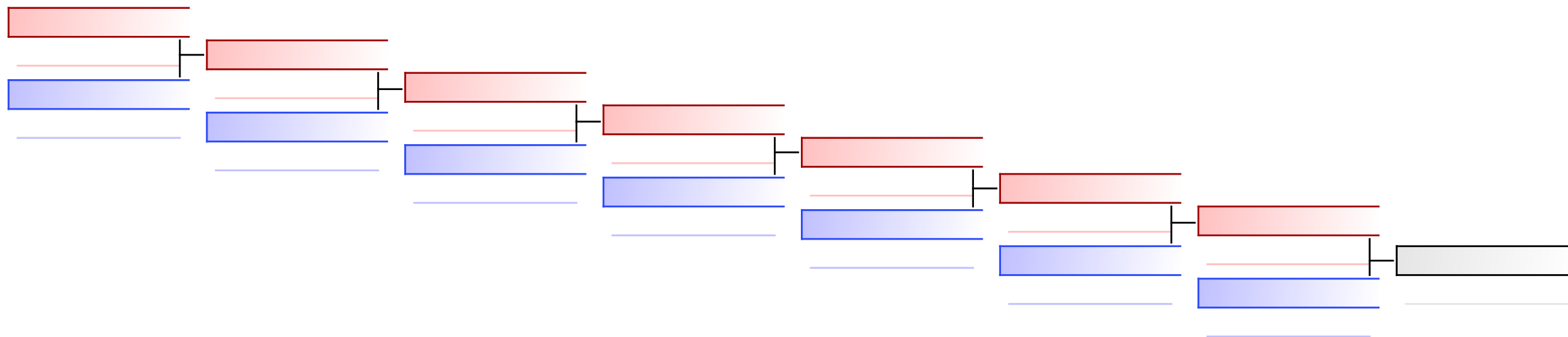

Referees:							
-----------	--	--	--	--	--	--	--

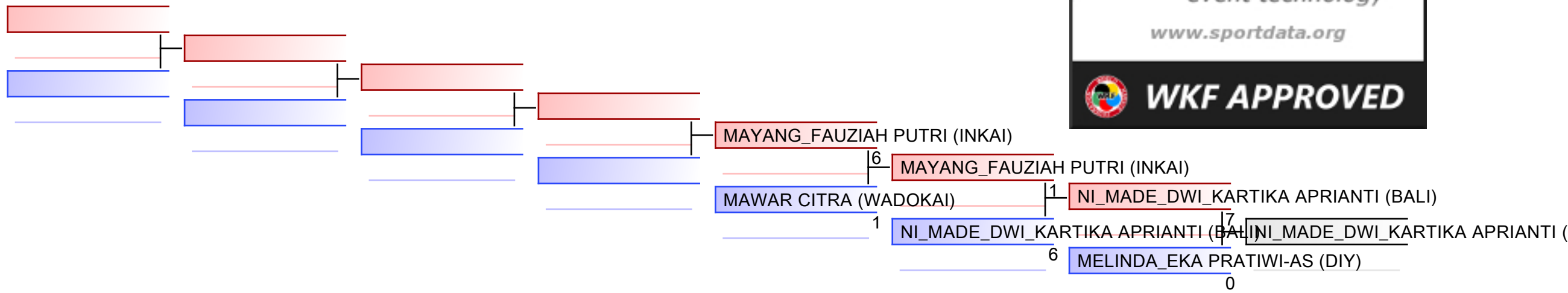

REPECHAGE: (2)

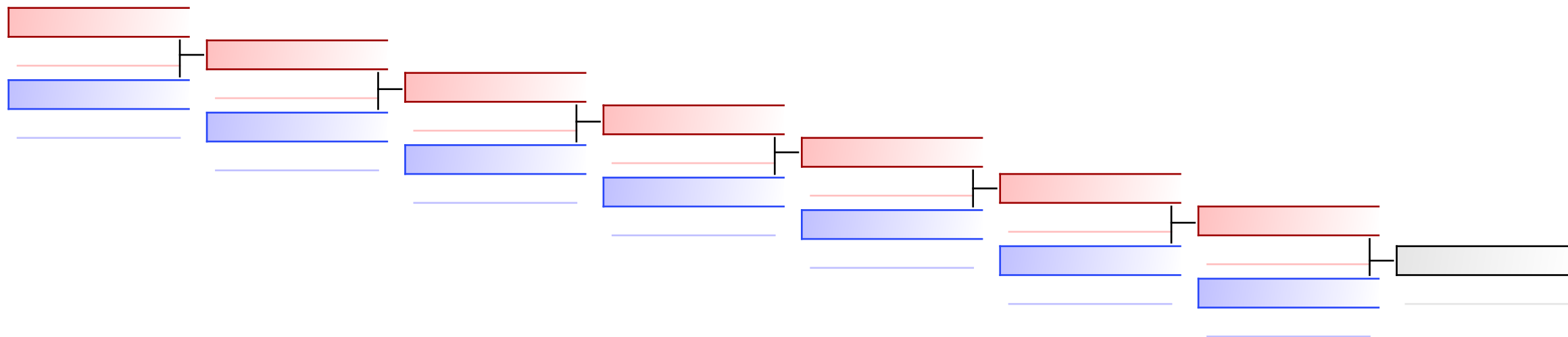

Referees:							
-----------	--	--	--	--	--	--	--

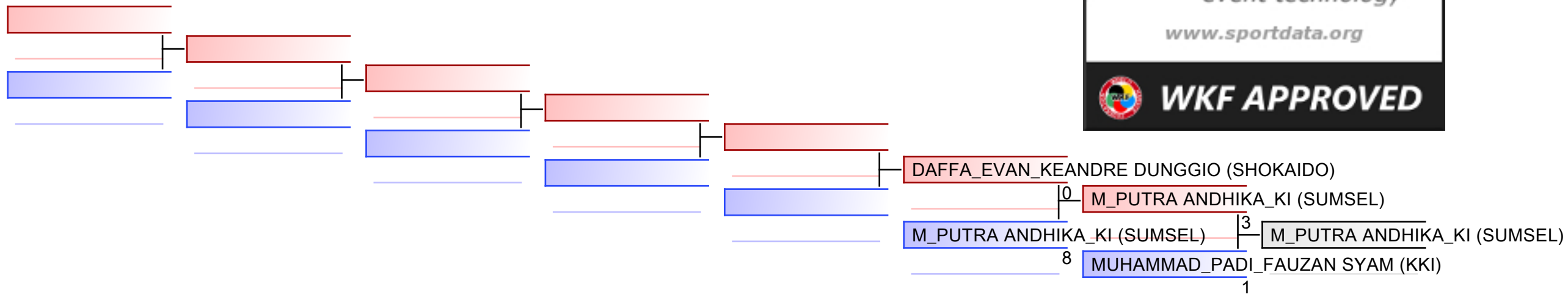

REPECHAGE: (1)

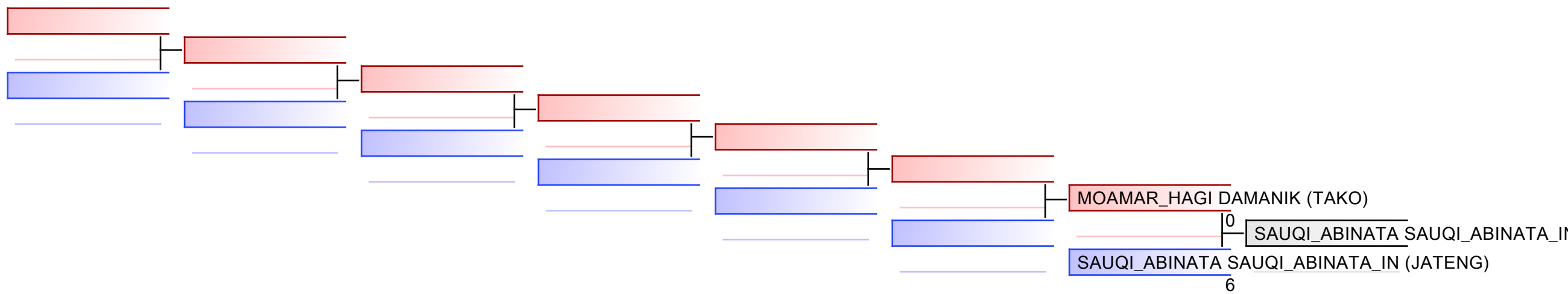

Referees:							
-----------	--	--	--	--	--	--	--

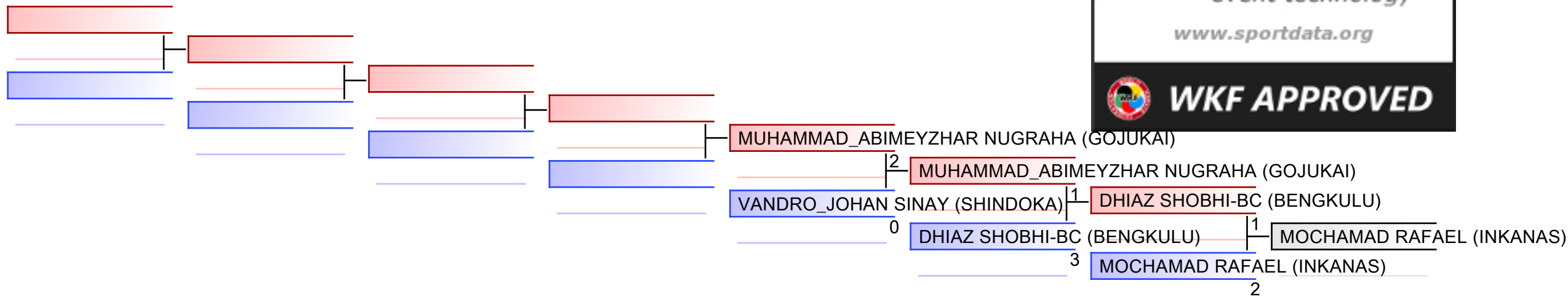

REPECHAGE: (1,2)

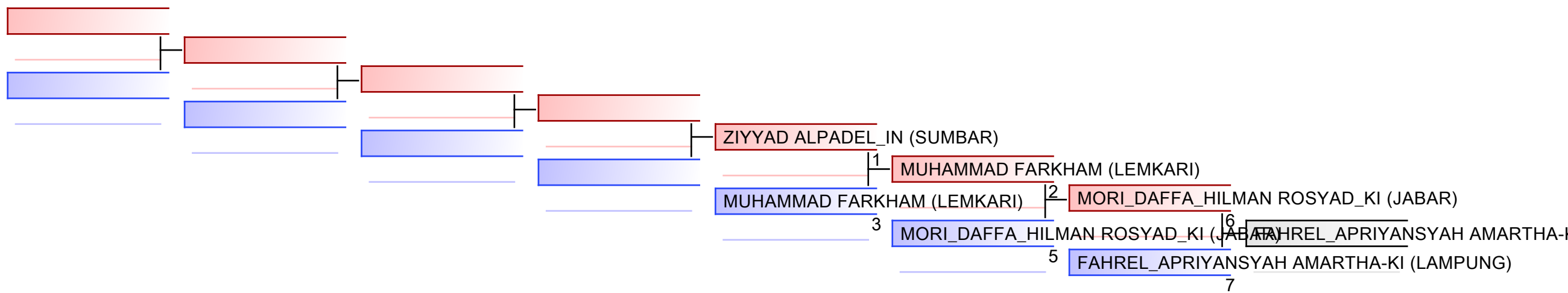

Referees:							
-----------	--	--	--	--	--	--	--

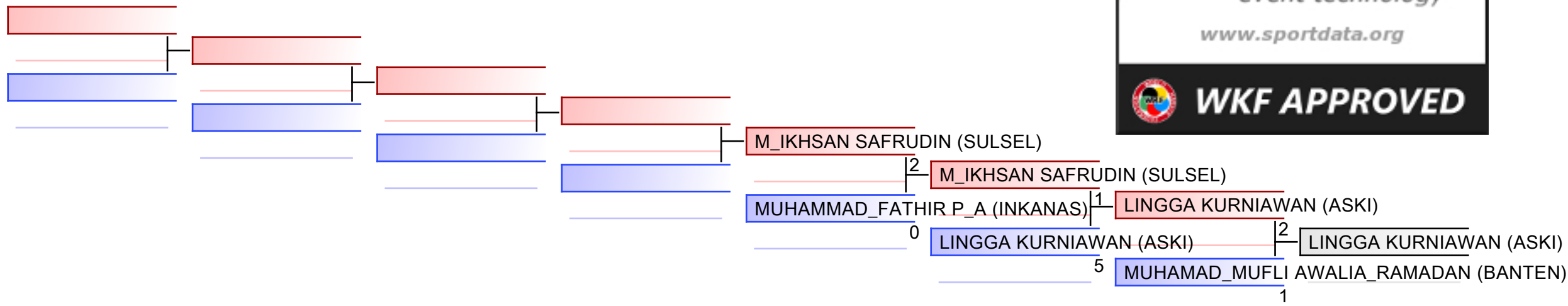

REPECHAGE: (2)

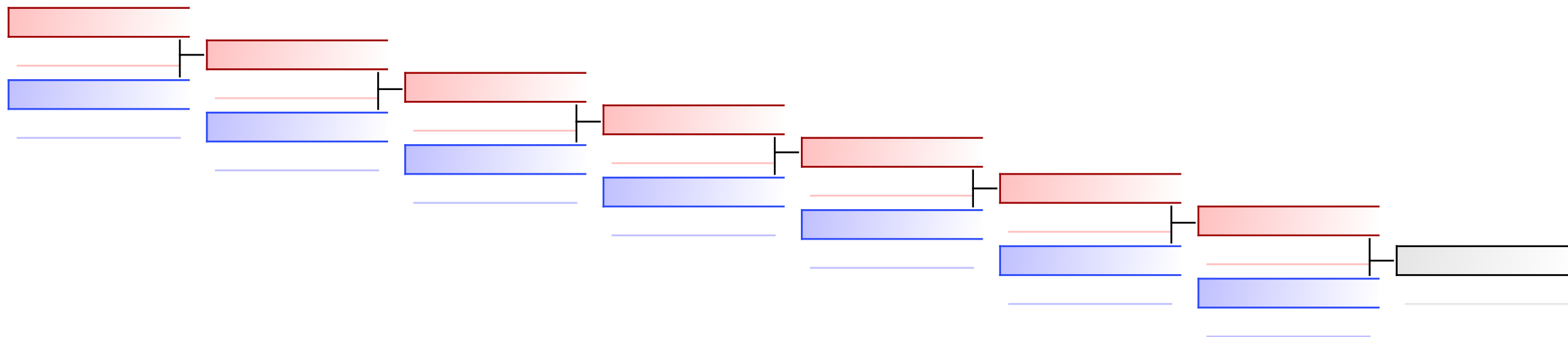

Referees:							
-----------	--	--	--	--	--	--	--

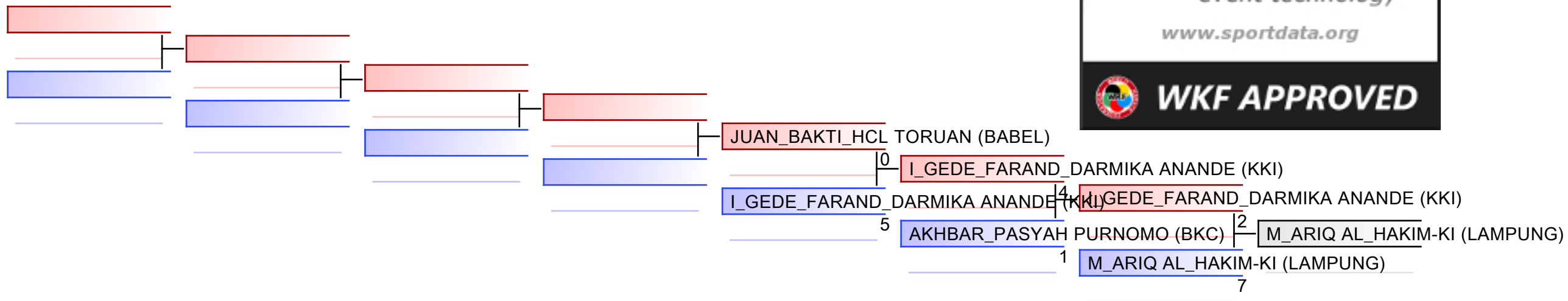

REPECHAGE: (1)

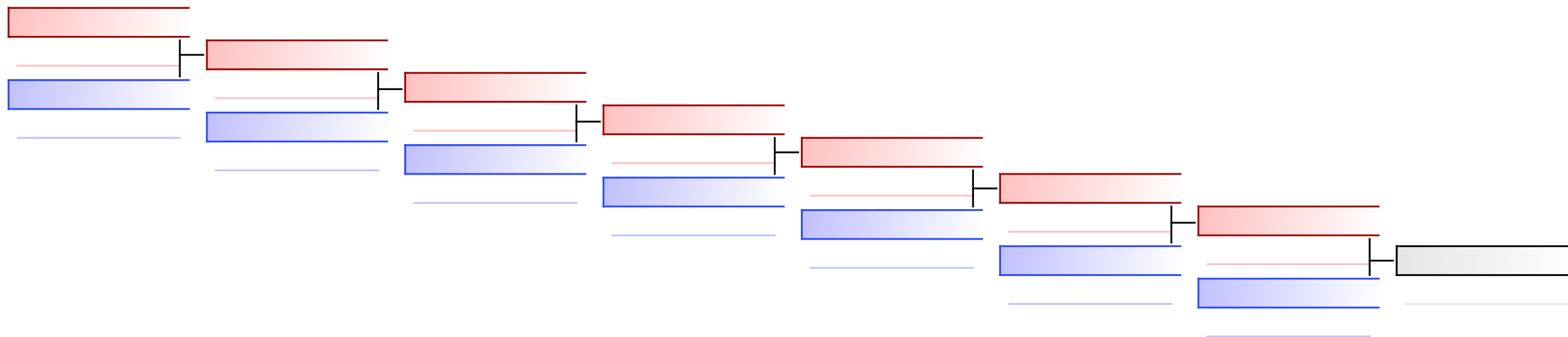

Referees:							
-----------	--	--	--	--	--	--	--

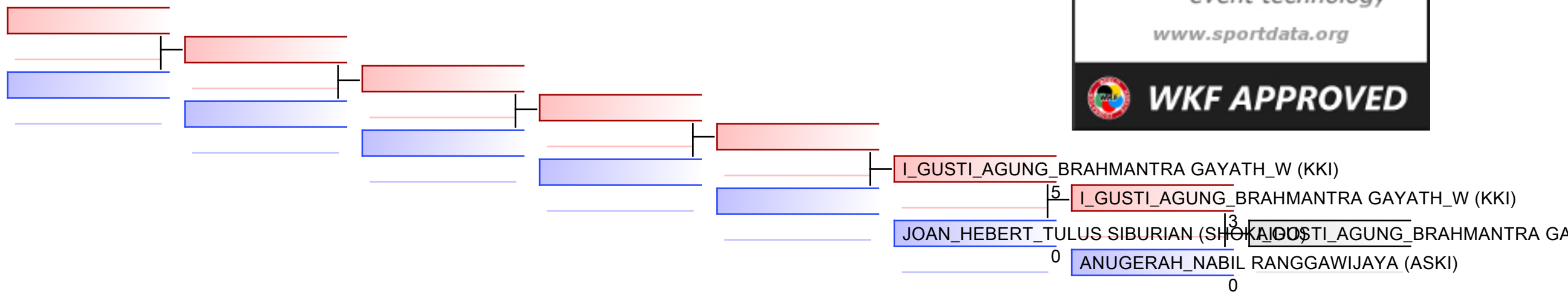

REPECHAGE: (1,2)

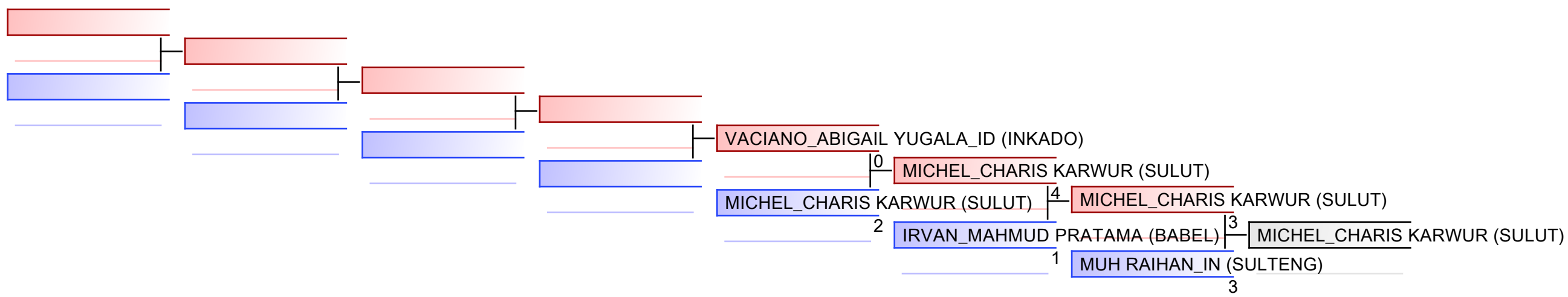

Referees:							
-----------	--	--	--	--	--	--	--

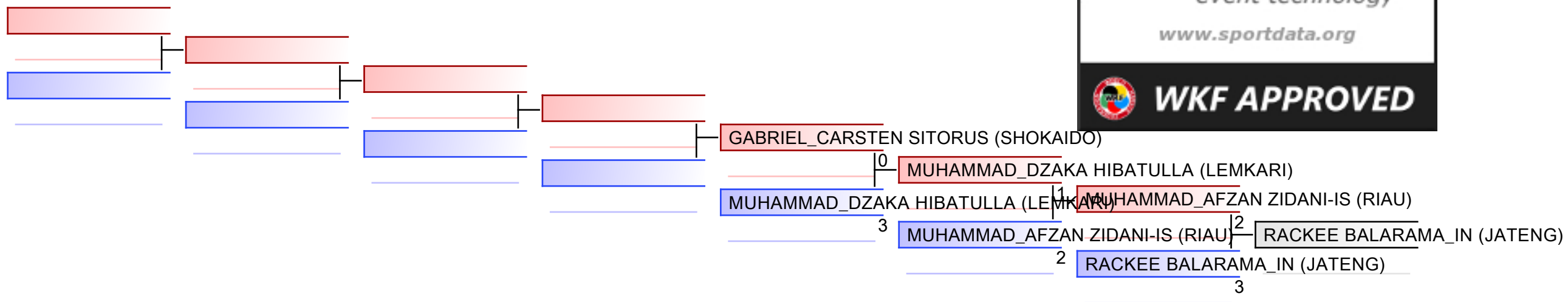

REPECHAGE: (1,2)

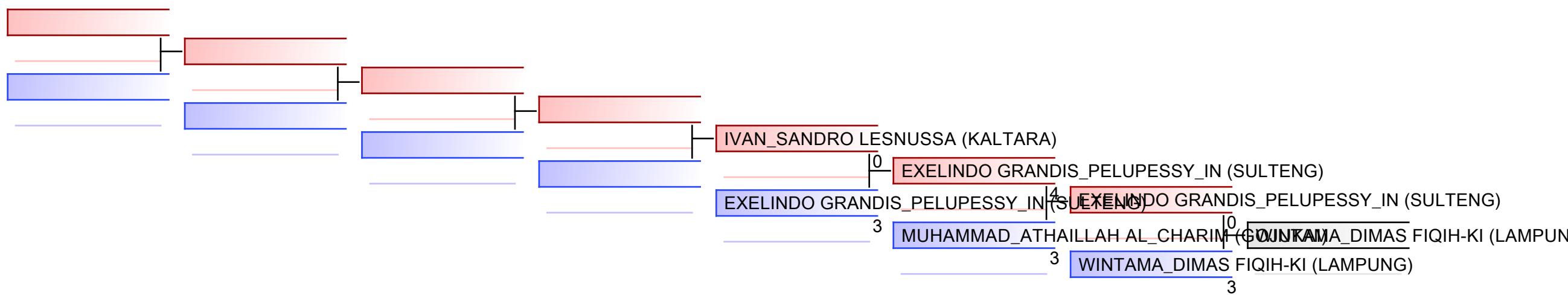

Referees:							
-----------	--	--	--	--	--	--	--

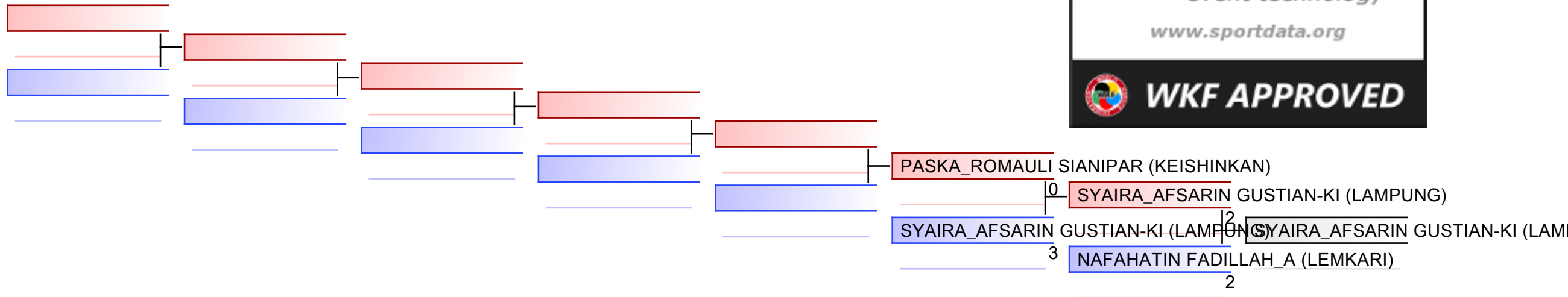

REPECHAGE: (1,2)

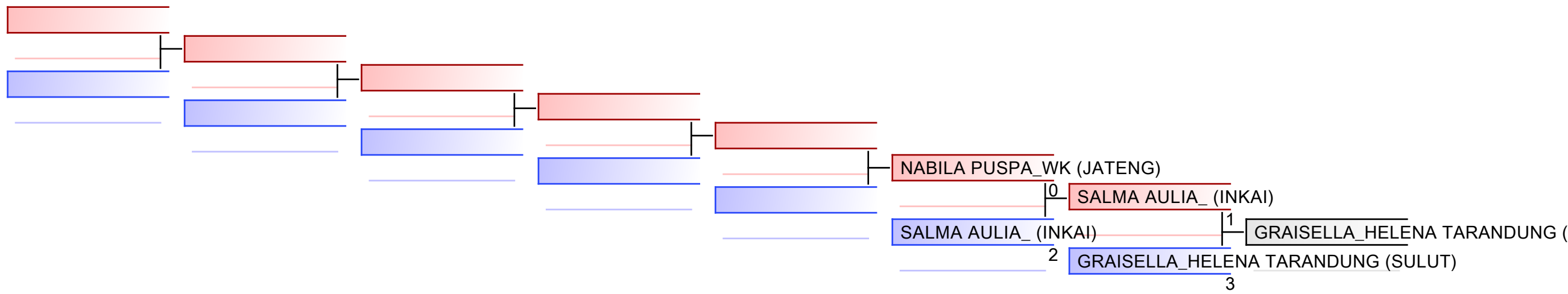

Referees:							
-----------	--	--	--	--	--	--	--

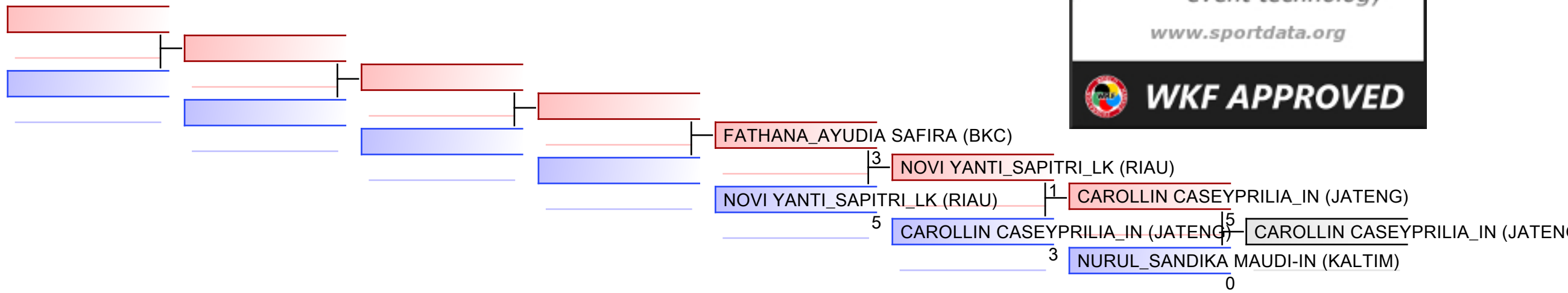

REPECHAGE: (1,2)

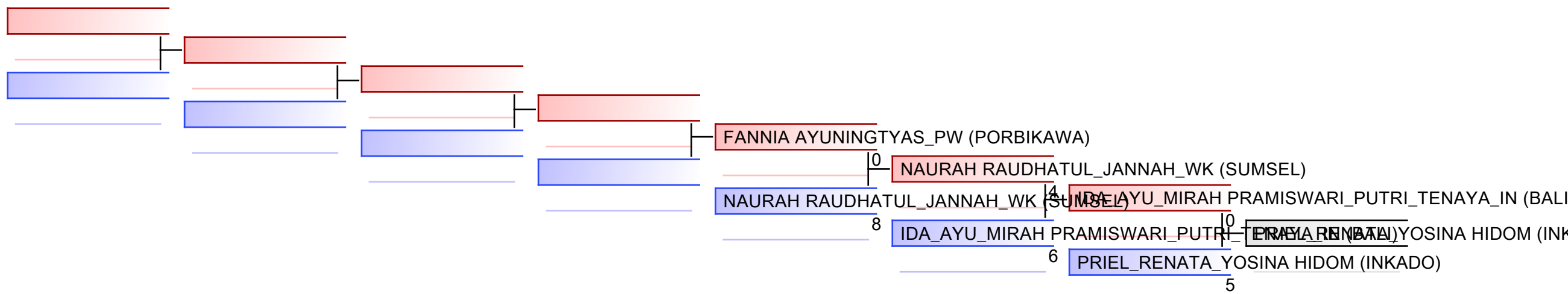

Referees:							
-----------	--	--	--	--	--	--	--

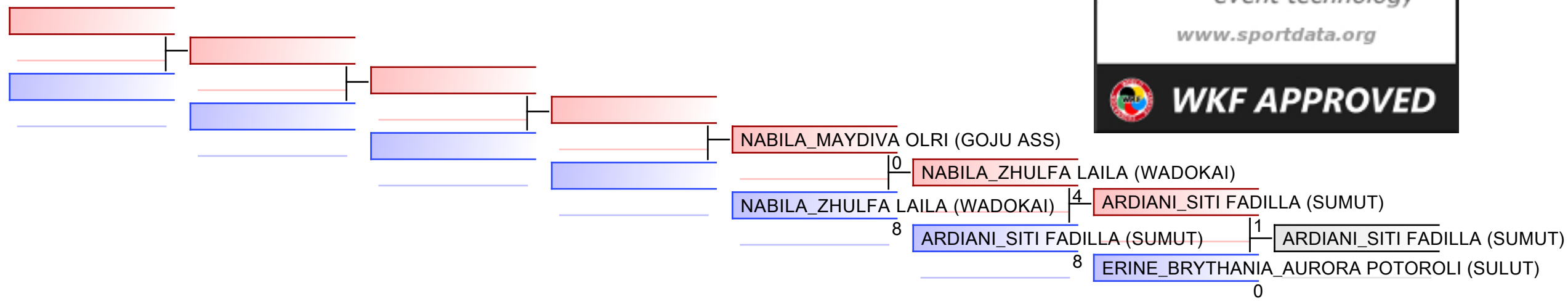

REPECHAGE: (1,2)

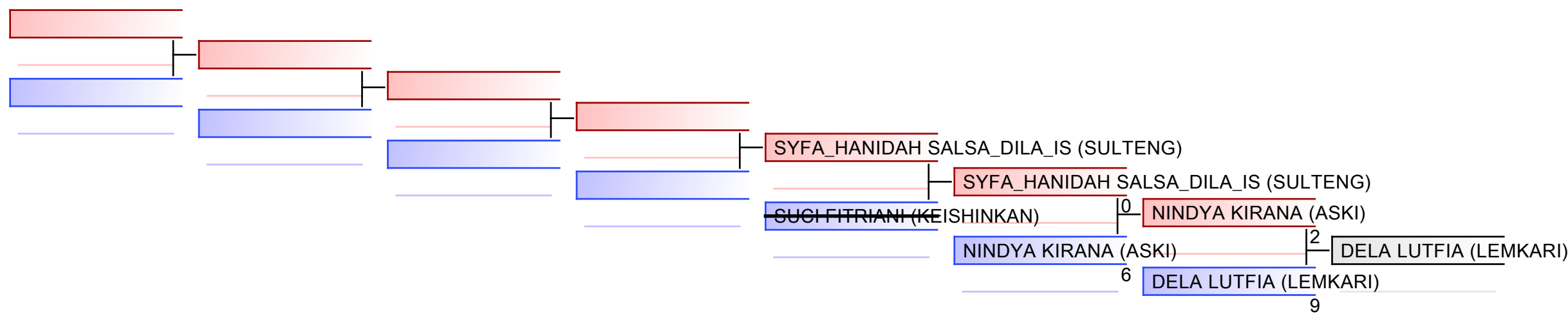

Referees:							
-----------	--	--	--	--	--	--	--

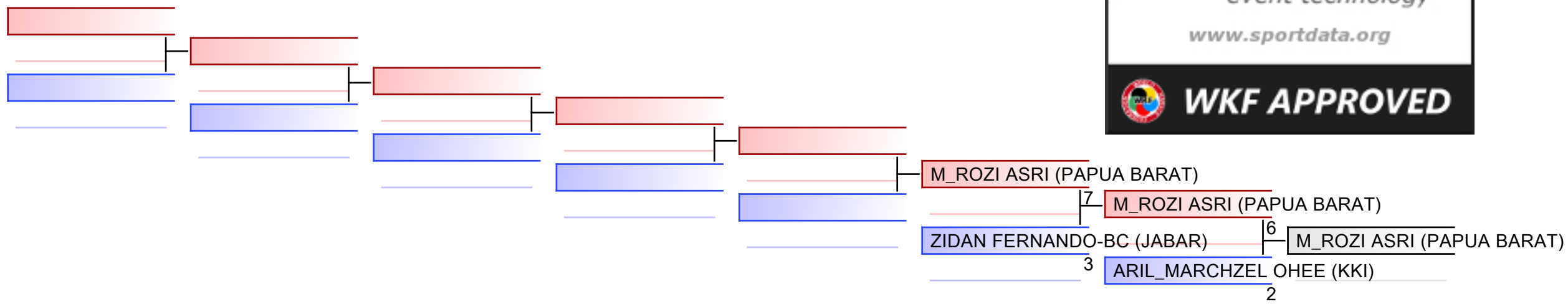

REPECHAGE: (1)

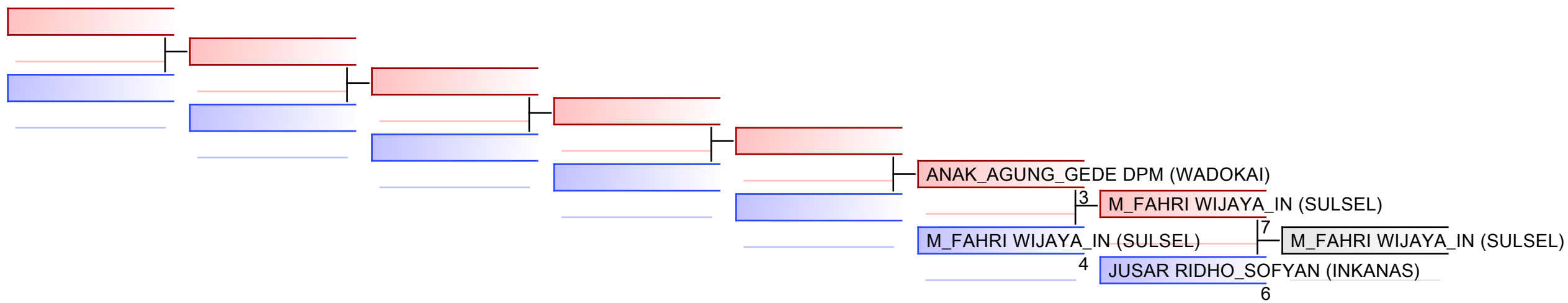

Referees:							
-----------	--	--	--	--	--	--	--

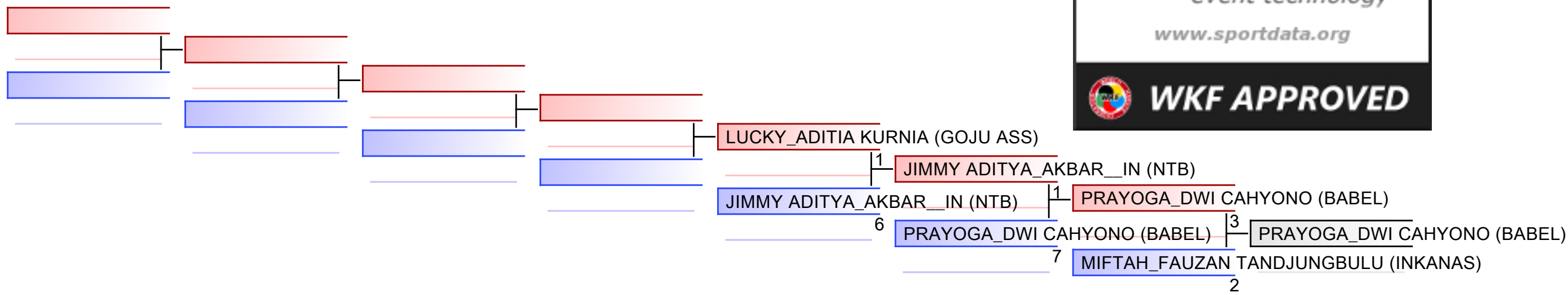

REPECHAGE: (1,2)

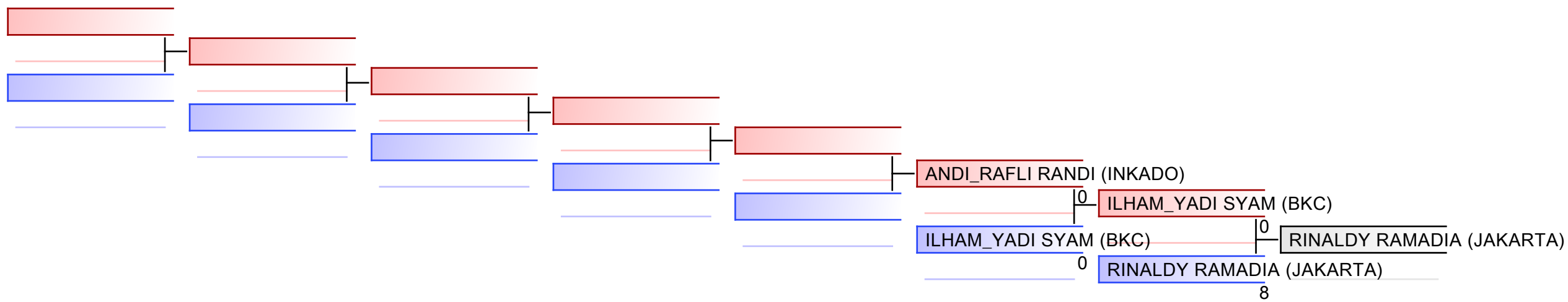

Referees:							
-----------	--	--	--	--	--	--	--

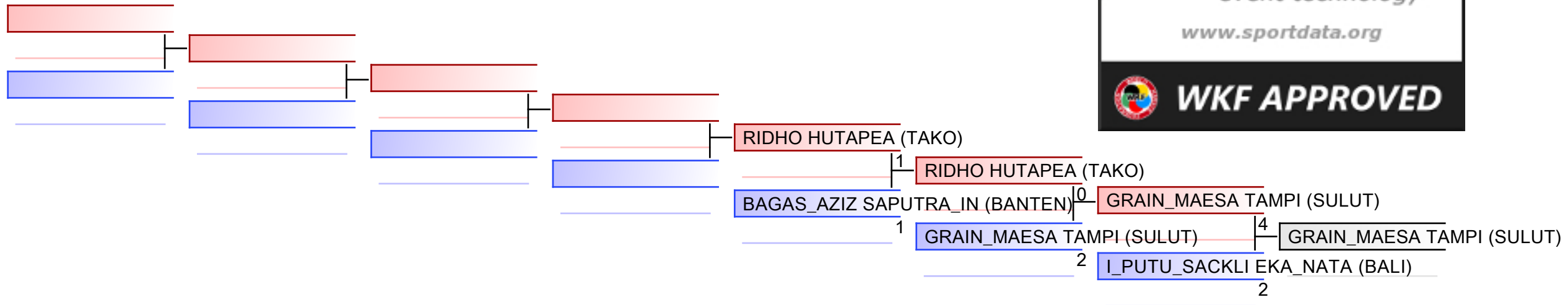

REPECHAGE: (1)

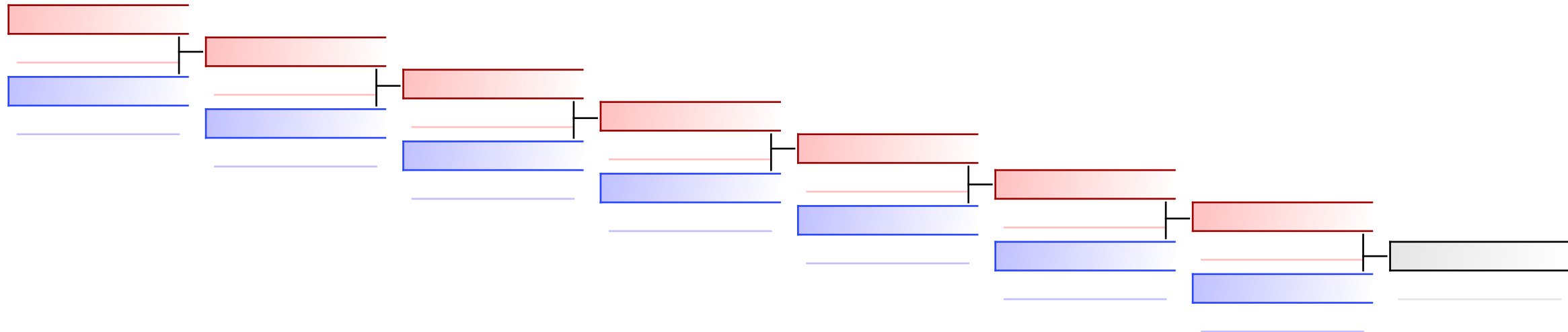

Referees:							
-----------	--	--	--	--	--	--	--

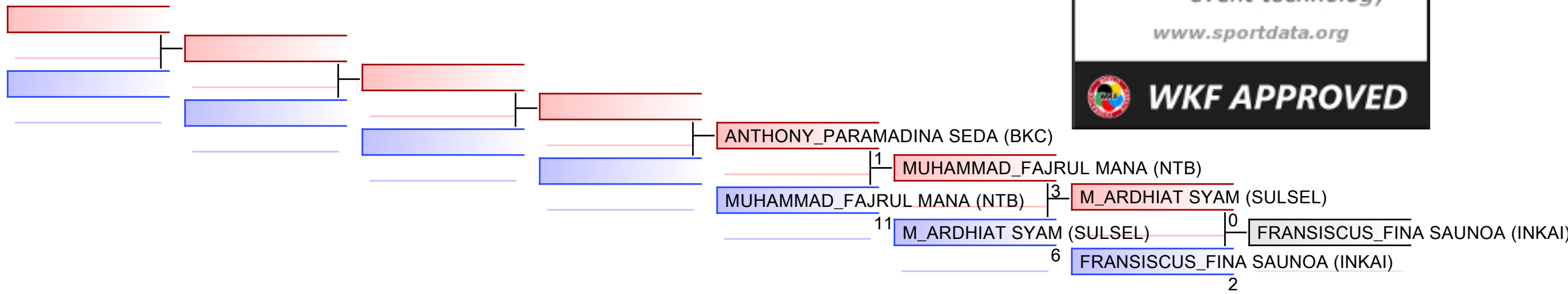

REPECHAGE: (2)

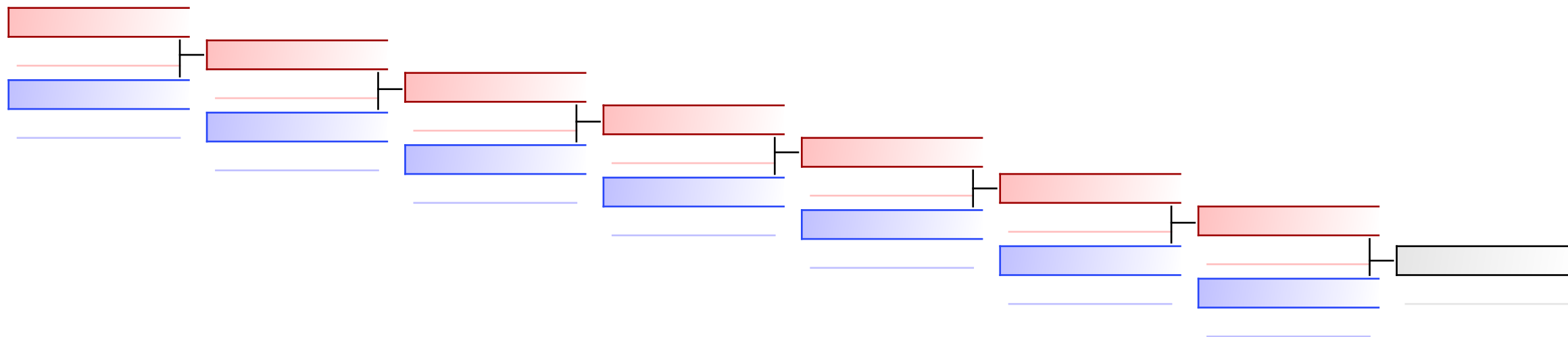

Referees:							
-----------	--	--	--	--	--	--	--

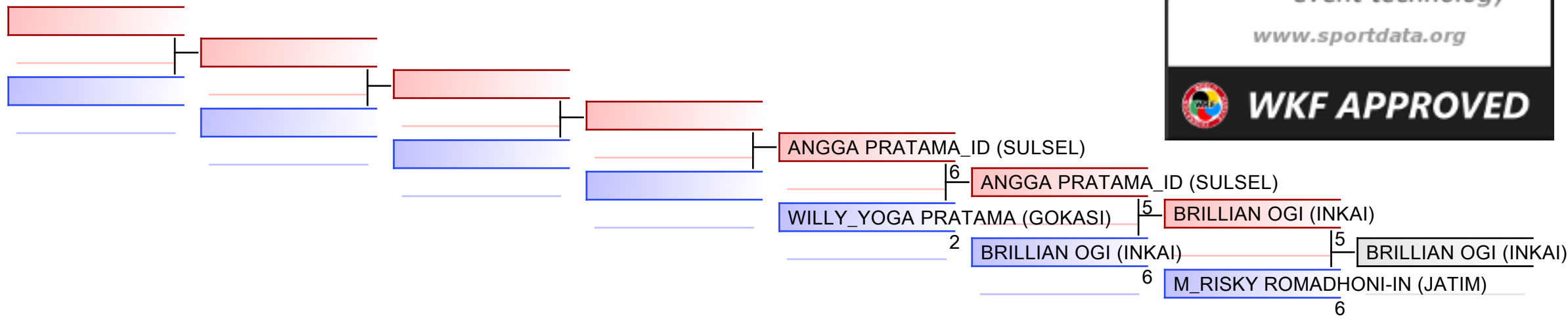

REPECHAGE: (2)

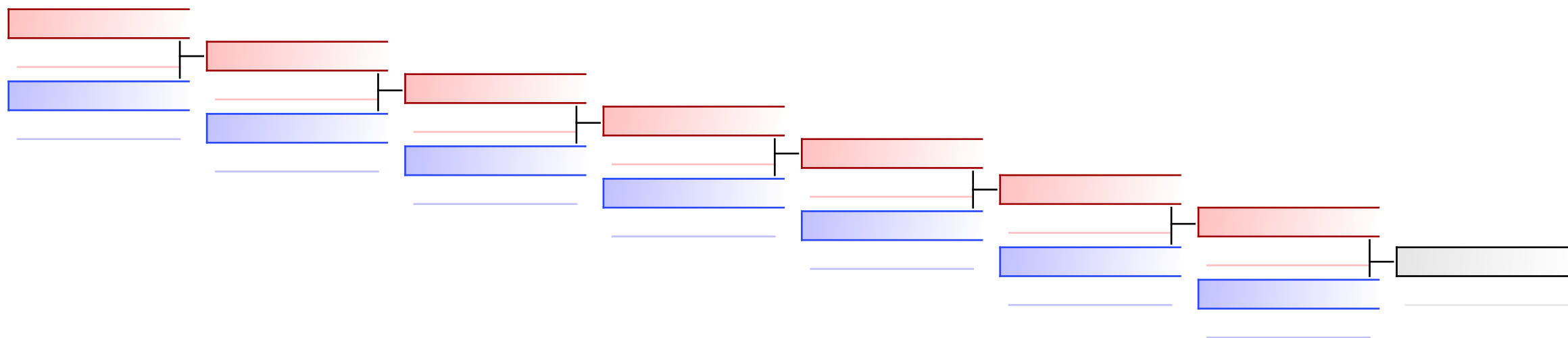

Referees:							
-----------	--	--	--	--	--	--	--

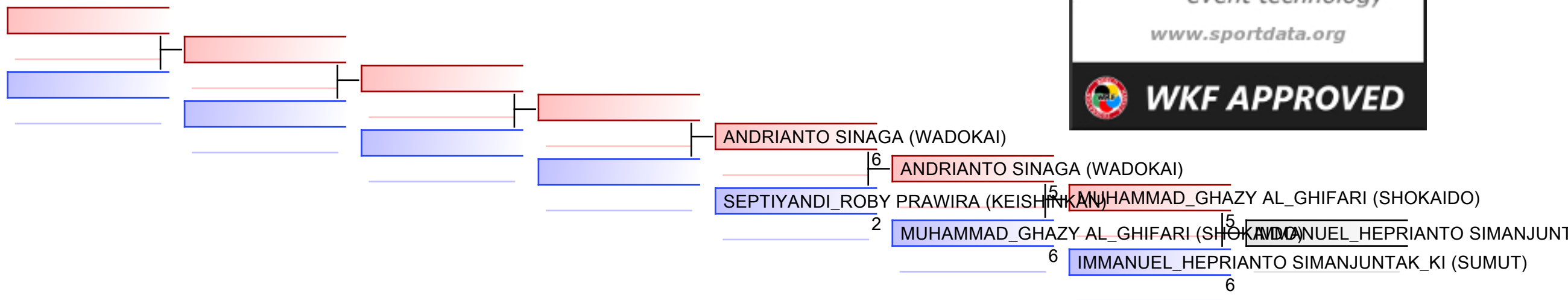

REPECHAGE: (1,2)

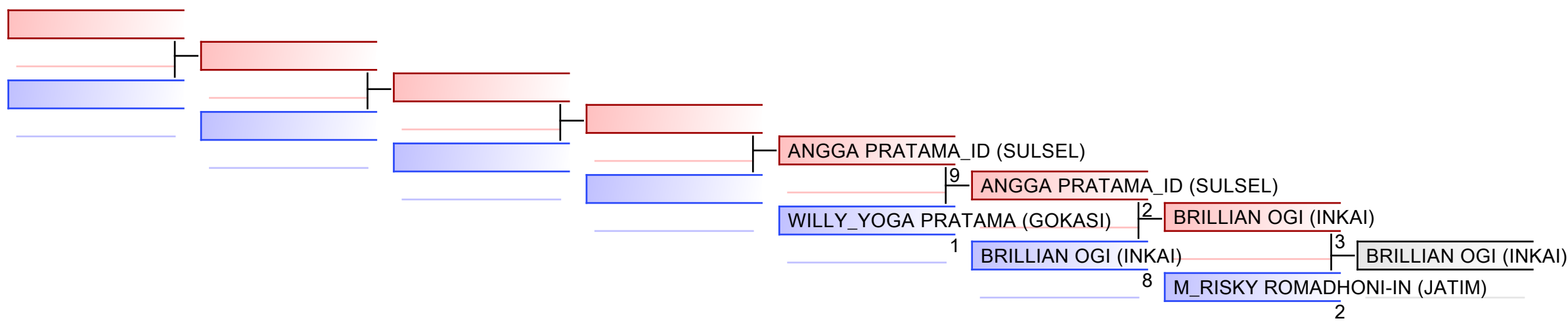

Referees:							
-----------	--	--	--	--	--	--	--

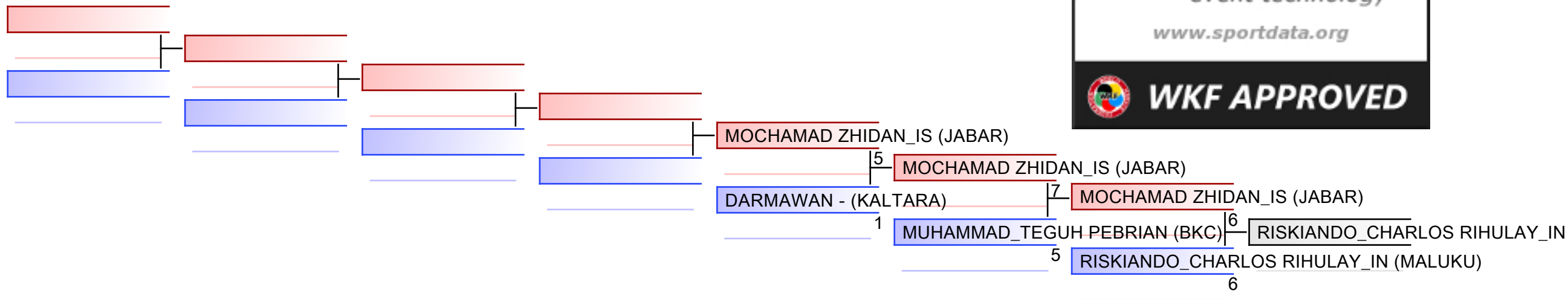

REPECHAGE: (1)

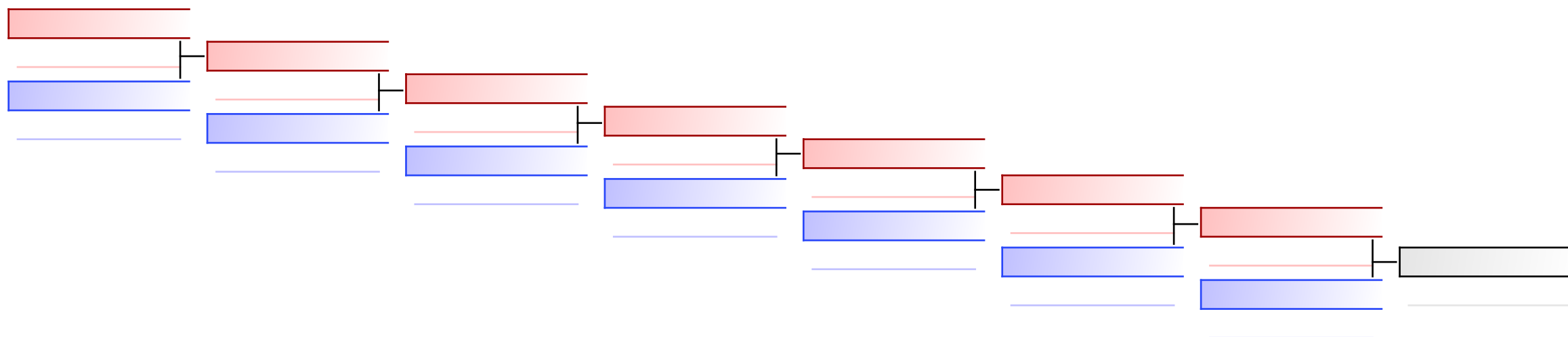

Referees:							
-----------	--	--	--	--	--	--	--

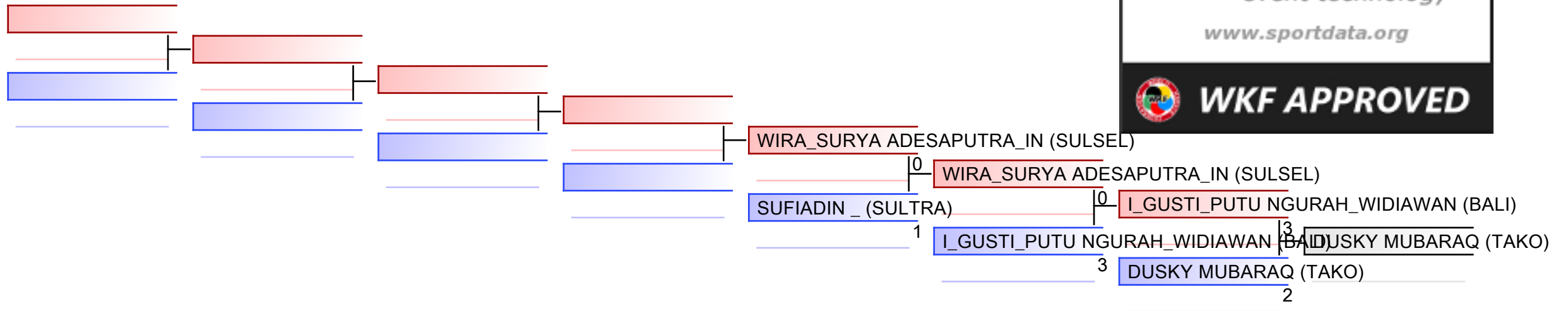

REPECHAGE: (2)

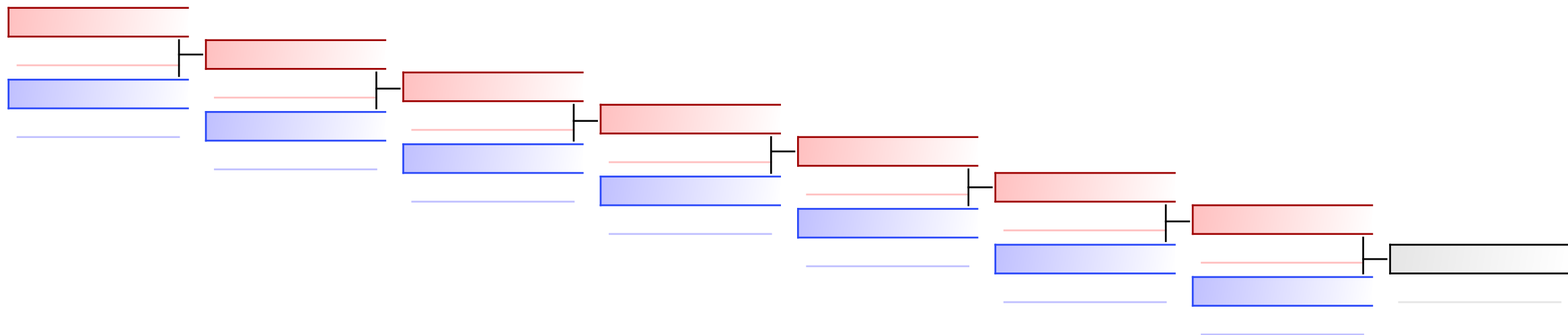

Referees:							
-----------	--	--	--	--	--	--	--

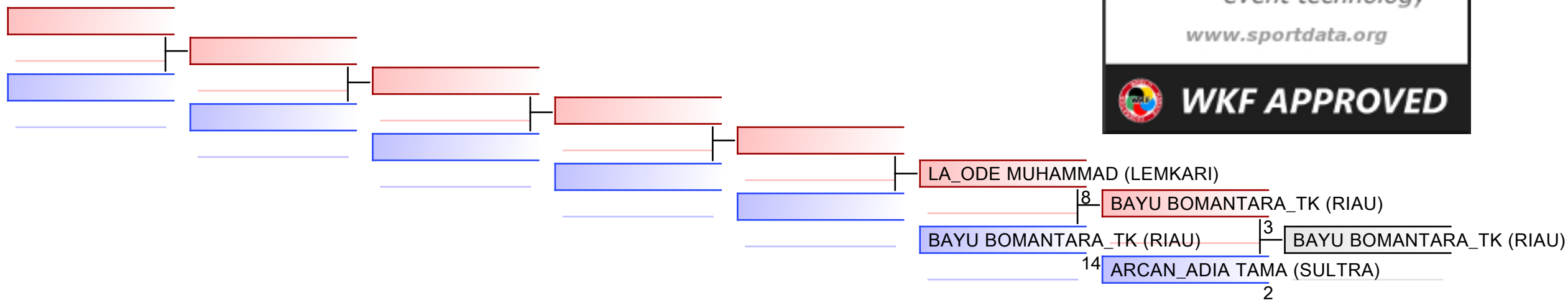

REPECHAGE: (1)

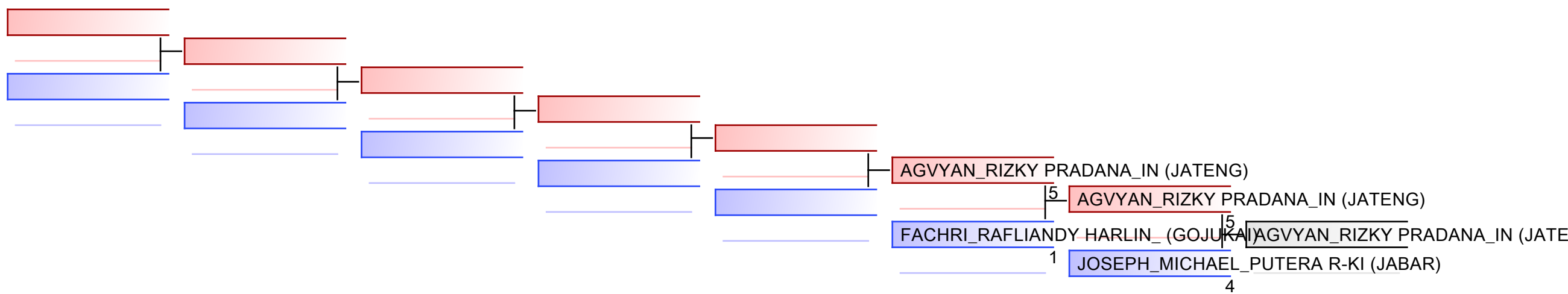

Referees:							
-----------	--	--	--	--	--	--	--

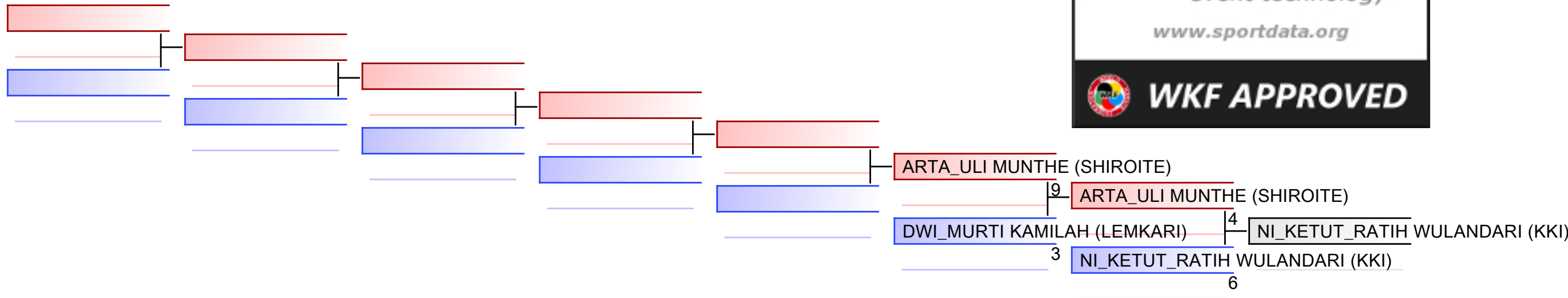

REPECHAGE: (1)

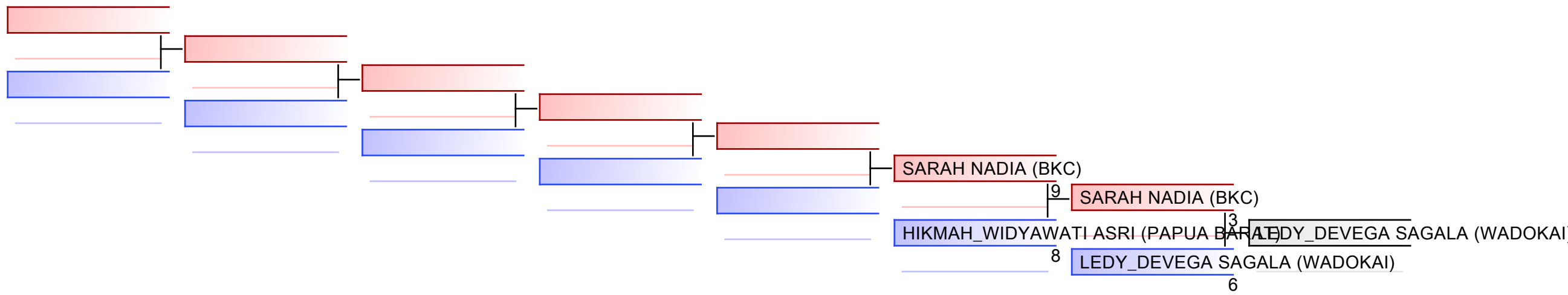

Referees:							
-----------	--	--	--	--	--	--	--

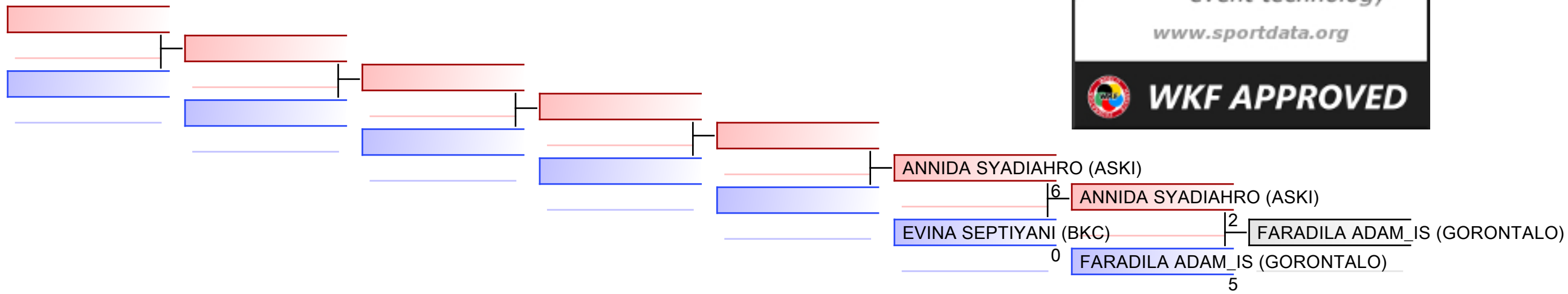

REPECHAGE: (1)

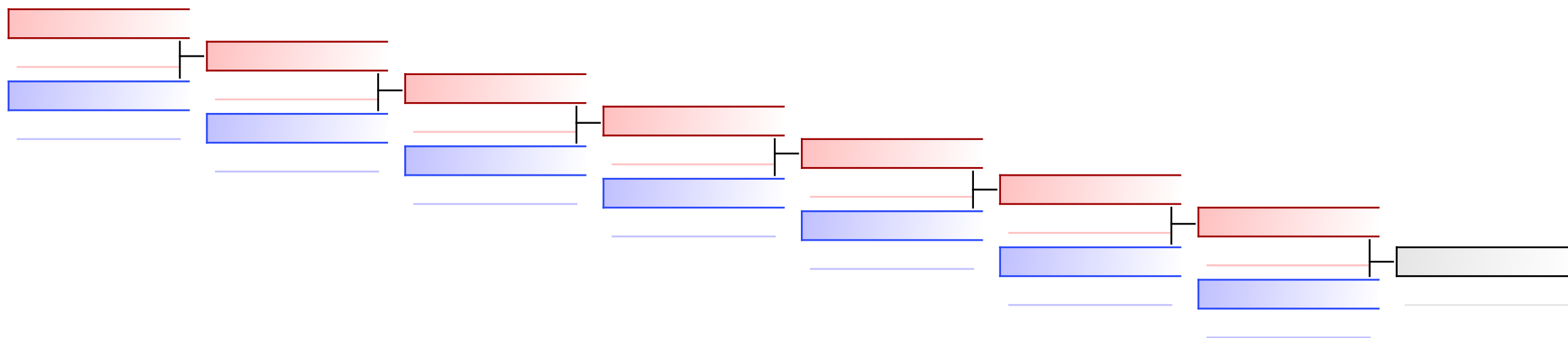

Referees:							
-----------	--	--	--	--	--	--	--

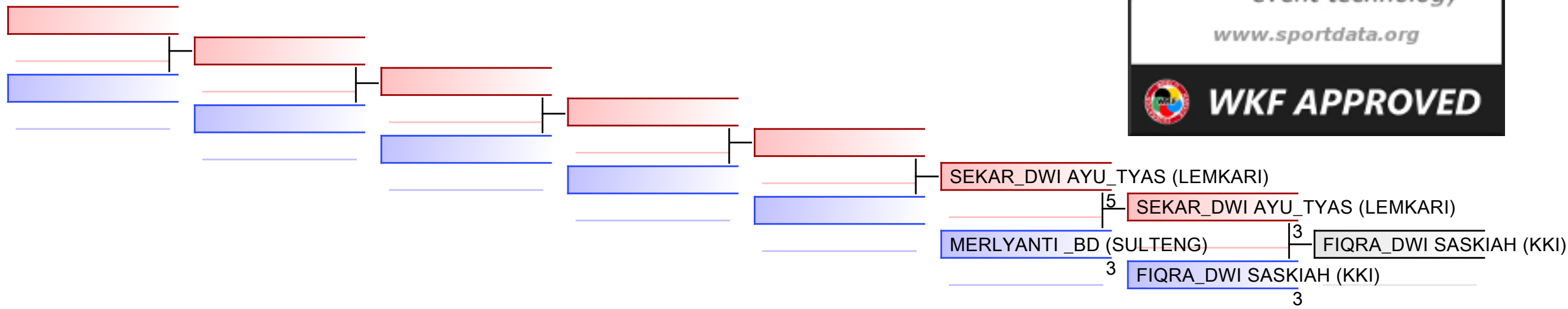

REPECHAGE: (2)

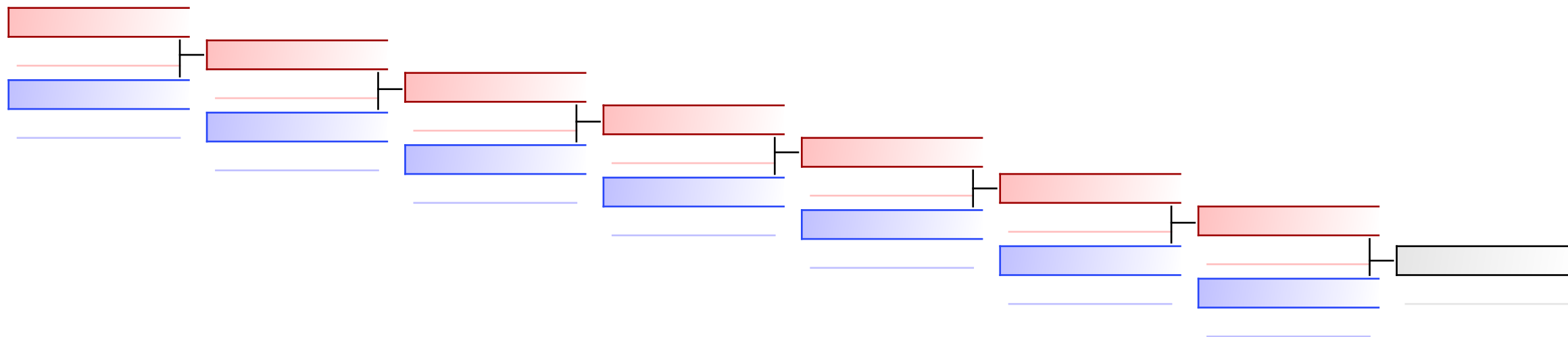

Referees:							
-----------	--	--	--	--	--	--	--

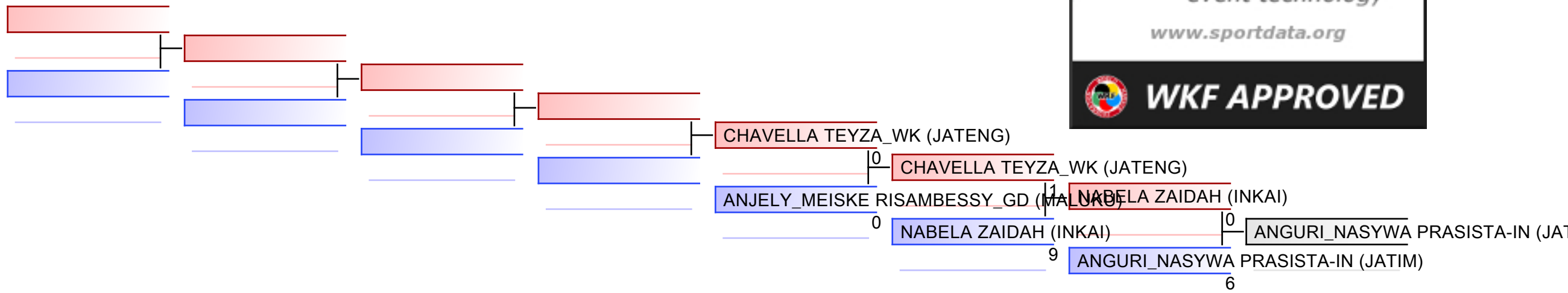

REPECHAGE: (1)

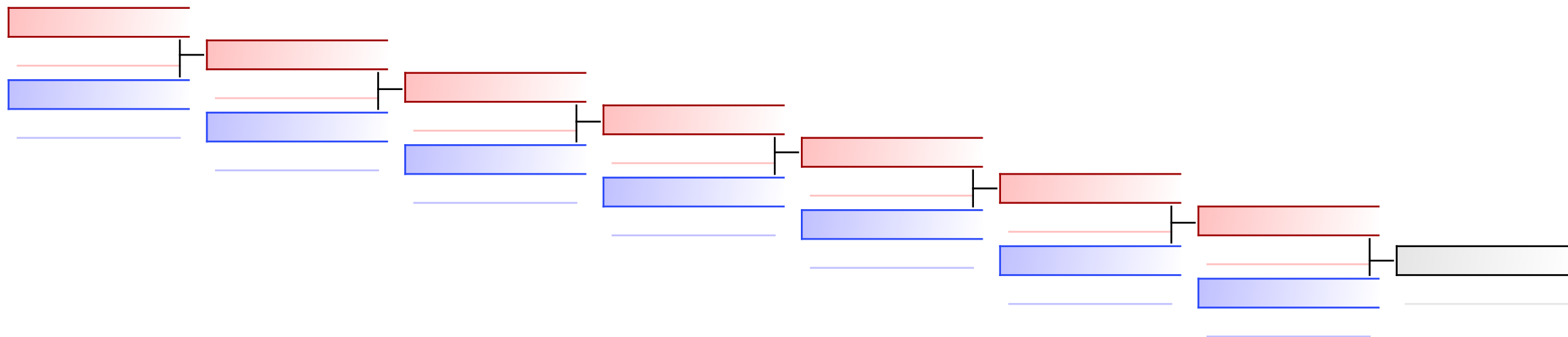

Referees:							
-----------	--	--	--	--	--	--	--

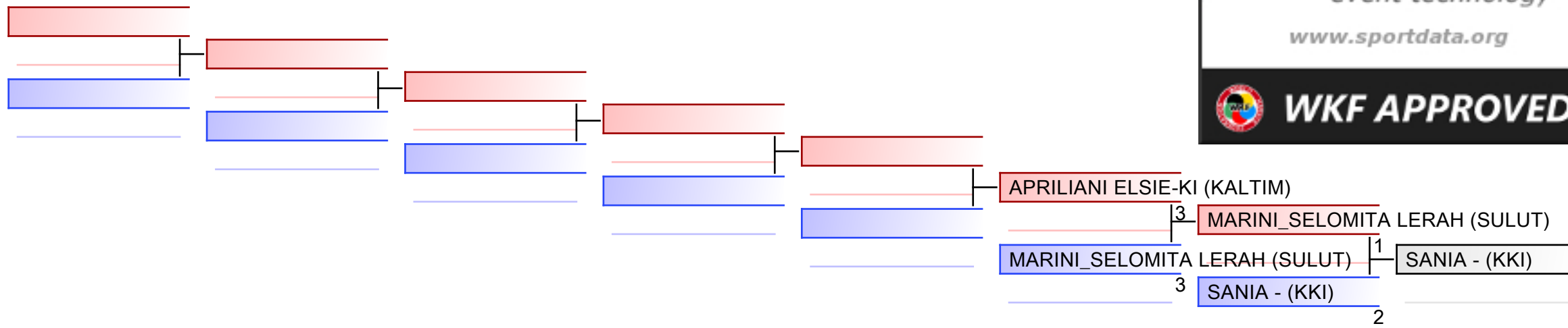

REPECHAGE: (2)

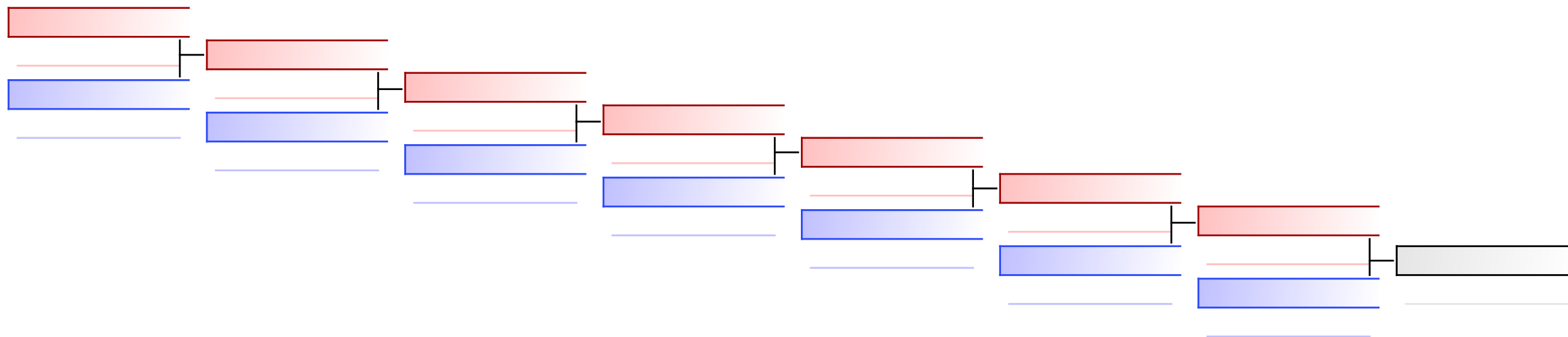

Referees:							
-----------	--	--	--	--	--	--	--

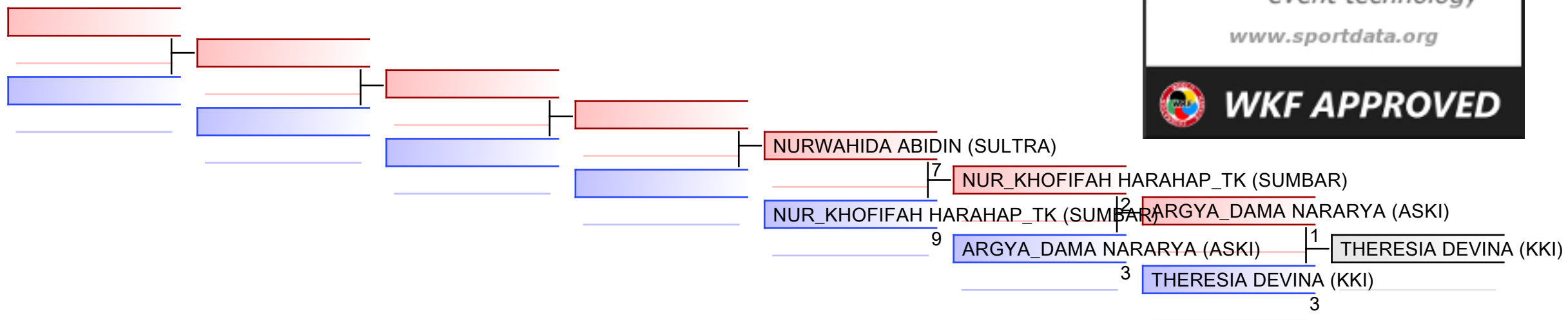

REPECHAGE: (2)

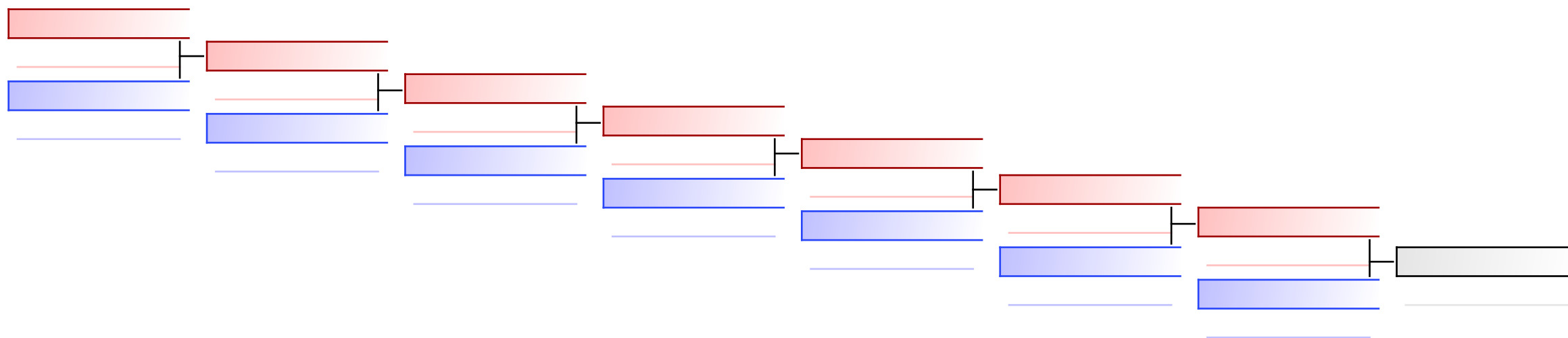

Referees:							
-----------	--	--	--	--	--	--	--

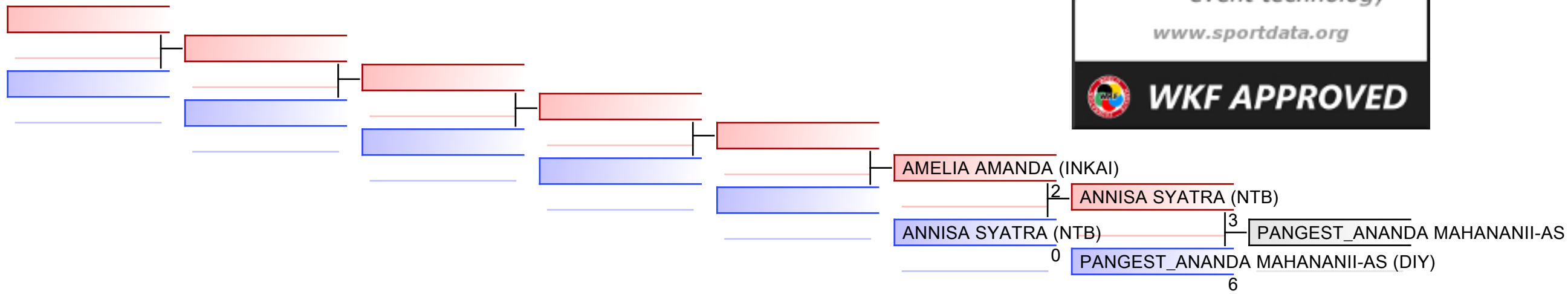

REPECHAGE: (1)

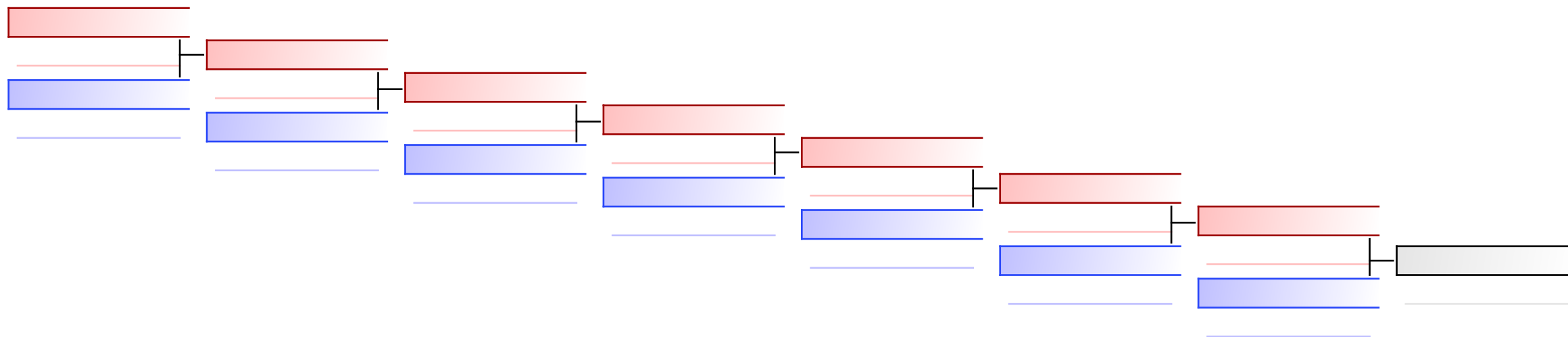

Referees:							
-----------	--	--	--	--	--	--	--

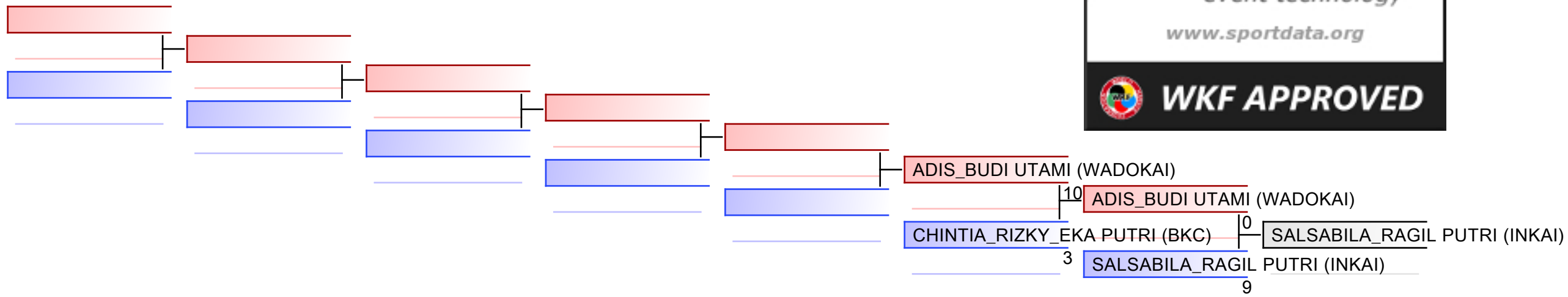

REPECHAGE: (2)

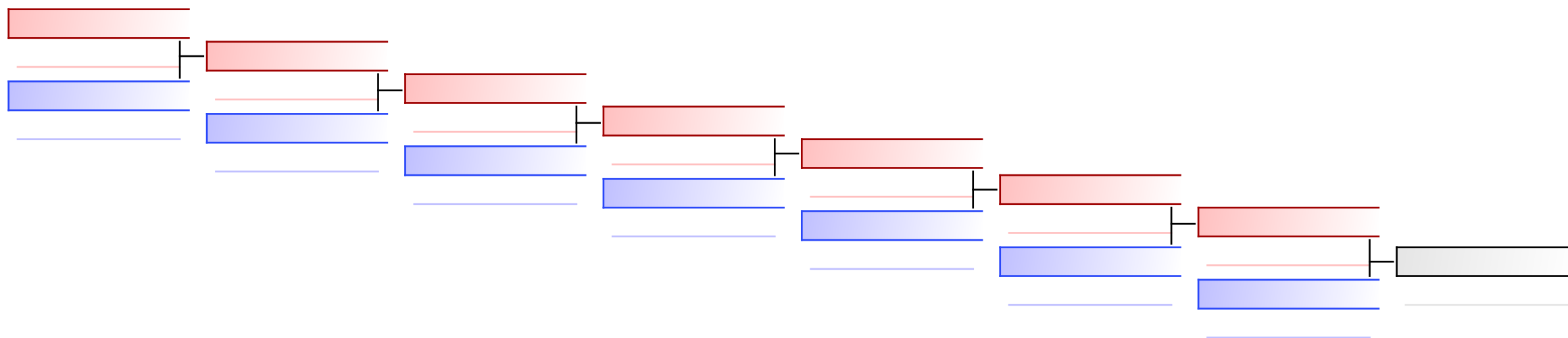

Referees:							
-----------	--	--	--	--	--	--	--

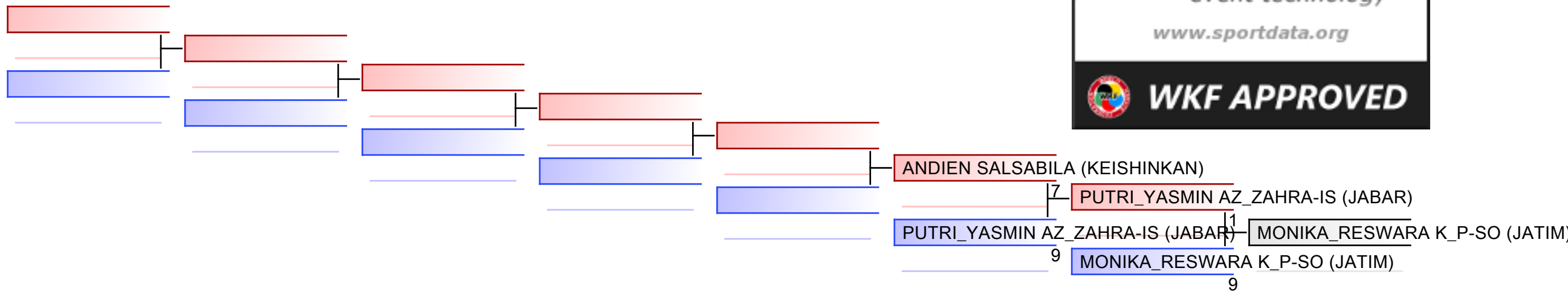

REPECHAGE: (1)

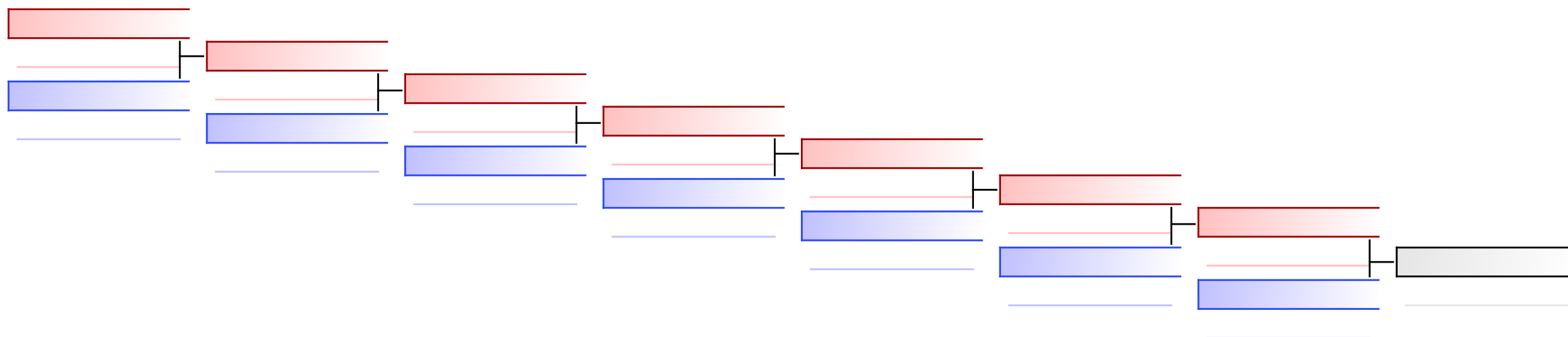

Referees:							
-----------	--	--	--	--	--	--	--